

e l e r o

Sun Shading Solutions Nice

Solutions

for intelligent building technology:
Drives, controls and sensors

Catalog 2024

complete digital version

Solutions

**for intelligent building technology:
Drives, controls and sensors**

**Tubular motors
Venetian blind drives
Special drives**

**Home automation
Controls
Sensors**

**Door drives
Door controls
Accessories**

**Adapterprofiles
Lifting capacity tables**



We are your partner

for innovative drive and control technology

Intelligent solutions for the home

Elero is one of the largest global manufacturers of electrical drives and control units for roller shutters and sun protection systems.

The drive manufacturer is a wholly-owned subsidiary of the Italian Nice Group and specializes in roller shutters and sun protection within Nice.

We are convinced that intelligent, comprehensive control of light and temperature significantly improves well-being and living comfort significantly. That is why we are constantly market requirements with constant further developments and offer innovative control systems for almost every requirement proven drive technology.

We are Nice

Business Unit
Sun Shading Solutions



The Vision: A world without barriers

Improving our quality of life, safety, living comfort and energy efficiency is at the heart of everything we do.

elero is a company of the Nice group, a global manufacturer of smart home, security and building automation solutions based in Oderzo, Italy. Nice employs more than 3,000 people in five continents and have 15 R&D centres and 14 production facilities serving partners and customers in over 100 countries. With its comprehensive product portfolio, Nice provides a complete ecosystem for buildings.

Founding the "Sun Shading Solutions" business unit at the beginning of 2021 set a major course for further international development in the sun protection market segment. This business division, which is headed by elero's managing director, is responsible for all of the Group's sun shading activities. Elero's expertise in this sector as well as the strength of Nice as an active global player should expand and secure the market position on an international level in the future.

Contents

Overviews

Pictograms – Legend	10
Drives	14
Control systems and sensors	17

Tubular drives

RevoLine S

RoTop S-868 / RoTop S	22
SunTop S-868 / SunTop S	28
VariEco S-868 / VariEco S	32
<i>RevoLine S – Accessories</i>	36

RevoLine M

RoMotion M-868 / RoMotion M	44
RoTop M-868 / RoTop M	50
SunTop M-868 / SunTop M	60
VariEco M-868 / VariEco M / NHK	66
<i>RevoLine M – Accessories</i>	72

RevoLine L RH / NHK

RoTop L-868 RH / RoTop L RH	86
SunTop L-868 RH / SunTop L RH	90
VariEco L RH / VariEco L NHK	94
<i>RevoLine L RH / NHK – Accessories</i>	98

JA Venetian Blind drives

JA Comfort /-868	110
JA Comfort SMI	111
JA / JA Soft	112
JAR / JAR Soft	113
JA NHK	114
<i>Venetian Blind drives – Accessories</i>	115

Speciality drives

Folding shutter drive	123
-----------------------	-----

Solar drive systems

RoSolar-868 DC	126
<i>Control systems and accessories</i>	132
<i>Solar drive systems</i>	134
<i>Control systems and accessories</i>	137

Control systems and Sensors

Home automation	141
Yubii Home	146
<i>Centero Home NXT</i>	168
Hand-held radio transmitters	172
Radio transmitters	182
Radio receivers	192
Wireless sensors	206
Wired control units	214
Sensors	226
Relay and special control systems	234
<i>Switches and push buttons</i>	241

Door drives

Type 15 W	244
Type 15 W NMA	245
<i>Type 15 – Accessories</i>	246

Door controls

DoorControl	251
<i>Door controls – Accessories</i>	252

Adapter profiles and Lifting capacity tables

Adapter profiles	254
Lifting capacity tables	276

Contact

<i>Contact persons and places</i>	278
-----------------------------------	-----

GTC

General terms and conditions	280
------------------------------	-----

RevoLine S + M tubular drives



RevoLine
S + M

RevoLine L RH / L NHK tubular drives



RevoLine
L RH / L NHK

Venetian blind drives



Venetian blind drives

Solar drive systems and speciality drives



Solar drive systems
Speciality drives

Home automation, radio control systems and wireless sensors



Radio control systems
Wireless sensors

Wired control systems, sensors and special control systems



Wired control units
Sensors

Door drives and door control systems

















Door drives
Door control units

Adapter profiles and lifting capacity tables









Adapter profiles
Lifting capacity tables

Applications

	Roller shutters		ZIP screen		Venetian blind / outdoor venetian blinds		Interior roller blind
	Awnings		Insect screen		Rolling door		Folding shutters
	Pergola		Door video intercom		Radiator thermostat		Radiant heater
	Lighting		RGB-lighting		Radio-controlled socket		

Technical features

	Bidirectional The ProLine 2 bidirectional radio system provides feedback and ensures reliable relaying of signals.		Wired Wired drive and control solutions for the automation of roller shutters and sun protection systems.
	Unidirectional The ProLine unidirectional radio system provides a reliable radio connection to receivers within range.		Plug & play The end positions are taught in automatically during the first movements. Rigid shaft connectors are necessary for this.
	Solar power Ecological drive solutions for motorising privacy and sun protection without a power connection..		Globalität Worldwide access possible

Networking

works with
Yubii® Home

Marked in the catalog with this logo

Almost all bidirectional elero radio drives and receivers can be integrated into the Yubii Home smart home environment (see page 146).

The Yubii Home compatibility list can be downloaded at

www.elero.com/yubiihome-compatibility

Drive advantages / user benefits



SilentMotion

Drives with optimised running behaviour move the blinds almost silently in quiet mode.



Soft brake¹

Drives with a soft brake stop the movement of the blind completely silently without any disturbing clacking noises.



Soft start²

Drives start and turn the slats at reduced speed particularly quietly and gently.



Soft stop²

Slow travel with reduced speed before the end positions and during slat turning.



Anti-blocking detection

Drives detect when the blind is frozen stuck or blocked and stop automatically.



Intelligent blind protection

Drives stop and move in the opposite direction a little if the blind meets an obstacle.



Anti push-up device

Motorised roller shutters with drives and mechanical anti push-up devices withstand break-in attempts for a long time.



End position adjustment³

Intelligent drives automatically compensate for changes in the winding behaviour of the blind over time.

¹ Soft brake up to 8 Nm for RevoLine S, up to 20 Nm for RevoLine M and 25 Nm for RevoLine L as well as up to 9 Nm for JA /JAR Soft drives and all JA Comfort (-868) drives

² Only in combination with soft brake

³ With at least 1 stop run

Environment



Sun sensor

The automatic control of the roller shutters and sun protection systems is optimally based on the light conditions.



Rain sensor

Sun protection systems are retracted and protected as soon as raindrops are detected by the rain sensor.



Temperature control

For an optimal room climate, blinds can also be automatically controlled based on the current temperature.



Wind sensor

Sun protection systems are retracted and protected as soon as strong wind is detected by the wind sensor.



Astro function

Efficient opening and closing of the blinds according to sunrise and sunset times.



Time control

Blinds are opened and closed at fixed times to simulate presence.



Twilight function

When dusk falls, the blinds lower automatically to protect against prying eyes and the cold.

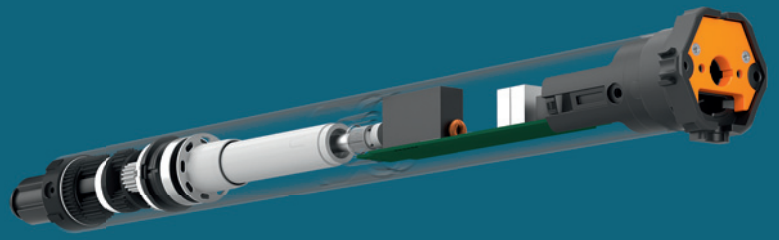

Perfect tubular drives

You can find out which drive has the desired functions in the overview from page 14.



Anti-blocking detection

Drives detect when the blind is frozen stuck or blocked and stop automatically.



Obstacle detection with free travel

The drive stops and moves a little in the opposite direction when the blind encounters an obstacle.



Soft start / Soft stop²

With reduced torque, the drive starts and stops particularly quietly and gently.



Softbremse¹

Drives with a soft brake stop the movement of the blind completely silently without any disturbing clacking noises.



Anti push-up device

Motorised roller shutters with drives and mechanical anti push-up devices withstand break-in attempts for a long time.



Learning power curve

Intelligent drives provide exactly the torque required and thus protect the system.



SilentMotion

Drives with optimised running behaviour move the blinds almost silently in quiet mode.



Plug & play

The end positions are taught in automatically during the first few journeys. Rigid shaft connectors are required for this.



Bidirectional / Wired

elero drives are available as wired versions or with the bidirectional radio system ProLine 2 is available.



Solar power

Ecological drive solutions for motorising privacy and sun protection without a power connection.

¹ Soft brake up to 8 Nm for RevoLine S, up to 20 Nm for RevoLine M and 25 Nm for RevoLine L

² Only in combination with soft brake

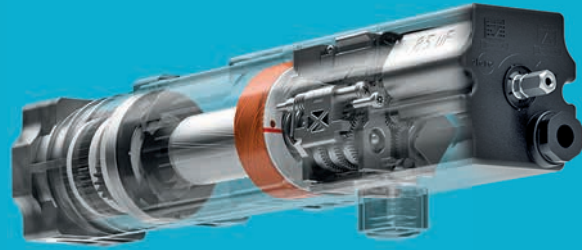

Perfect Venetian Blind drives

You can find out which drive has the desired functions in the overview from page 16.



Anti-blocking detection

Drives detect when the blind is frozen stuck or blocked and stop automatically.



End position adjustment

Reference runs ensure the blinds are always optimally positioned in the end positions.



Soft start/Soft stop²

With reduced torque, the drive starts and stops particularly quietly and gently.



Soft brake¹

Drives with a soft brake stop the movement of the blind completely silently without any disturbing clacking noises.



Bidirectional/Wired

elero drives are available as wired versions or with the bidirectional radio system ProLine 2 is available.



Solar power

Ecological drive solutions for motorising privacy and sun protection without a power connection.

¹ Soft brake up to 9 Nm for JA /JAR Soft drives and for all JA Comfort (/ -868) drives

² Only in combination with soft brake

Drives









































































Applications / drive advantages / user benefits / features

Item	Page	Applications	Drive advantages / user benefits	Features
RevoLine S				
RoITop S-868	24			
RoITop S	25			
RoITop/D+ S-868	26			
RoITop/D+ S	26			
RoITop/T S-868	27			
SunTop S-868	30			
SunTop S	31			
VariEco S-868	34			
VariEco S	34			
VariEco S -K	35			
RevoLine M				
RoIMotion M-868	46			
RoIMotion M	47			
RoIMotion/D+ M -868	48			
RoIMotion/D+ M	49			
RoITop M-868 /-K	52			
RoITop M /-K	54			
RoITop/D+ M-868	56			
RoITop/D+ M	56			
RoITop/D+ M NHK	57			

Item	Page	Applications	Drive advantages / user benefits	Features
RoTop M-868 s_onro	58		 	
RoTop M s_onro	58		 	
RoTop/J M-868	59		 	
RoTop/J M	59		 	
SunTop M-868	62	 	 	
SunTop M	63	 	 	
SunTop/Z M-868	64	 	 	
SunTop/Z M	65	 	 	
VariEco M-868 VariEco+ M-868	68	 		
VariEco M VariEco+ M	69	 		
VariEco M NHK	70	 		
RevoLine L				
RoTop L-868 RH	88	 	 	
RoTop L-RH	89	 	 	
SunTop L-868 RH	92	 	 	
SunTop L RH	93	 	 	
VariEco L RH	96	 		
VariEco L NHK	97	 		

Drives

Applications / drive advantages / user benefits / features

Item	Page	Applications	Drive advantages / user benefits	Features
Venetian blind drives				
JA Comfort-868 JA Comfort	110		    	 
JA Comfort SMI	111		    	
JA Soft	112			
JA e / dk	112			
JAR Soft	113			
JAR dk	113			
JA NHK	114			
Speciality drives				
Folding shutter drive	123			
Solar drive systems				
RoSolar-868 DC	130	 	     	 
RoSolar /D+ -868 DC	131		      	  
VariEco M DC	136	 		 
VariEco M-868 DC	136	 		 
SunTop L-868 DC	136	 	 	 
JA Soft DC	136			 
Door drives				
Type 15 W Type 15 W NMA	244 245			

























Control systems and sensors

Applications / features / environment

































Item	Page	Applications	Features	Environment
Smart Home				
Yubii Home	146			
Centero Home NXT	169			
Hand-held transmitters				
VarioSon-868 Slide	174			
LumeroSon-868 (Slide)	174			
LumeroSon-868 Mini MonoSon-868 Mini	175			
VarioCom (Slide)	176			
LumeroCom MonoCom (Slide)	176			
TempoTel 2	178			
MultiTel 2	178			
VarioTel 2	178			
LumeroTel 2 MonoTel 2	179			
Radio transmitters				
VarioSon W-868	184			
LumeroSon W-868 MonoSon W-868	185			
AstroTec-868	186			
AstroTec-868 bidi	186			

Control systems and sensors

























































Applications / features / environment

Item	Page	Applications	Features	Environment
MonoTec-868	187	      		
QuinTec-868	187	     		
Invio-868 UniTec-868 UniClic-868	188 189 189	       	 	

Radio receivers

VarioTec-868	194	    	 	
Unio-868	195		 	
Revio-868 /P /SW	196	      ⁵		
AeroControl-868	197	 		
Combio-868 JA /Pulse /RM	198	    	 	
Combio-868 HE /LI	199	 	 	
Combio-868 LI-D	201			



















































































Wireless sensors

Sensero-868 AC	208	 	  	  
Sensero-868 AC /Plus	208	 	  	   
Aero-868 /AC	209	    	  	 
Aero-868 /Plus Aero /Z-868 Plus	209	    	  	 
Protero-868	210		 	
Lumero-868	210	    	  	
Lumo-868	211	 	 	 

⁵ only Revio-868 SW

Control systems and sensors

Applications / features / environment

Item	Page	Applications	Features	Environment
Wall-mounted units				
AstroTec TempoTec AstroClic	216 217 217	   		   ⁶
AeroTec	218	  		   
VarioTec	218	    		
TimeTec	219	   		
Sensors				
Lumo	228	  		
Lumero	228	    		
Thermostat	229	  	 	
Aquero	229	 		
Aero	230	  		 
Relay and special control systems				
ExitSafe	236	  		
VarioTec-868 DC	237	    	  	
Central control units	238	   		
Control Unit DC	240	  		 ⁷  ⁷  ⁸  ⁹
Door control systems				
DoorControl	251		 	

⁶ only AstroTec and AstroClic

⁷ in combination with AstroTec and AeroTec

⁸ in combination with AstroTec

⁹ in combination with AeroTec

elero

RevoLine S

Tubular drives

RoITop S /-868	24.
RoITop/D+ S /-868	26.
RoITop/T S-868	27.
SunTop S /-868	30.
VariEco S /-868	34.
VariEco S /-K	35.
RevoLine S accessories	36.

RoTop S-868 / RoTop S



RoTop-868 S / RoTop S tubular drives of the S series are especially suitable for small roller shutters, roller blinds and screens. Functions such as blind protection, intelligent force measurement and soft brake (up to 8 Nm) ensure gentle operation. All drives can be easily installed and adjusted in a time-saving manner. RoTop drives are

available with and without an integrated radio system. With a diameter of 35 mm and for shaft sizes of min. Ø 38 mm, the drives are ideally designed for space-saving systems. Configurations of 1.5 to 12 Nm and, depending on the version, 11 to 70 rpm are available. The RoTop/T S-868 is specially designed for dual screens with its jog/rest mode.

RoTop S drives are available with different drive heads:

White drive head

- Up to 5 Nm
- Suitable for RevoLine motor bearings in conjunction with a motor bearing or intermediate plate

Radio control



Wired



Black drive head

- Min. 5 Nm
- Suitable for RevoLine motor bearings in conjunction with a motor bearing or intermediate plate



Bidirectional routing with ProLine 2



ProLine 2, the bidirectional radio system from elero, is more reliable, powerful and transparent than unidirectional radio standards. At the heart of the technology (868 MHz) are bidirectional radio components

(transceivers) that are capable not only of receiving, but also of confirming and relaying the signals. As soon as a command has been executed on the drive, the user receives feedback and can be sure that the commands are being executed correctly.



Applications	RoTop S-868 RoTop S	RoTop S-868 RoTop S high-speed version	RoTop/D+ S-868 RoTop/D+ S	RoTop/T S-868
Page	24/25	24/25	26	27
Roller shutters	•	•	•	
Roller blinds and screens	•	•		
Dual screens				•

TOP functions	RoTop S-868 RoTop S	RoTop S-868 RoTop S high-speed version	RoTop/D+ S-868 RoTop/D+ S	RoTop/T S-868
Special features	End positions freely adjustable	High-speed version	Plug & play / self-learning end positions	Jog/rest mode, high-speed version
Mechatronic end position detection with soft cut-out	•	•	•	•
Intelligent force measurement	•	•	•	•
Upward/downward blind protection and free travel	•	•	•	•
Self-learning end positions with release function			•	
End positions can be adjusted with assembly cable and/or hand-held* transmitter	•	•		•
Parallel connection possible (wired version only)	•	•	•	
Only in conjunction with rigid shaft connectors			•	

* Only for 868 MHz radio drives

Technical data	RoTop S-868 RoTop S	RoTop S-868 RoTop S high-speed version	RoTop/D+ S-868 RoTop/D+ S	RoTop/T S-868
Rated torque (Nm)	5 to 12	1,5 to 5	5 to 12	1,5 to 5
Rated speed (rpm)	11 and 17	30 and 70	17	30 and 70
Min. shaft diameter (mm)	38	38	38	38
Diameter (mm)	35	35	35	35
Length (mm)	Min. 525	Min. 545	Min. 545	Min. 545
Noiseless soft brake (up to 8 Nm)	•	•	•	•
Protection class (IP)	44	44	44	44
Limit switch range (rev.)	40	80 to 160	40	80 to 160
Ambient operating temperature (°C)	-20 to +60	-20 to +60	-20 to +60	-20 to +60
Conformity				
Plug-in connection cable, 2.0 m	•	•	•	•

End position programming		RoTop S-868 RoTop S	RoTop S-868 RoTop S high-speed version	RoTop/D+ S-868 RoTop/D+ S	RoTop/T S-868
Oben	Unten				
To stop	Freely adjustable	•	•		
Freely adjustable	To stop	•	•		
To stop	To stop	•	•	•	
Freely adjustable	Freely adjustable	•	•	•	•

RolTop S-868

Radio tubular drives for roller shutters and textile sun protection¹

Mechatronic end position detection with soft cut-out, intelligent force measurement, upward/downward blind protection and free travel, end positions adjustable by radio control or with assembly cable, bidirectional radio control (868 MHz) with automatic routing function and feedback for radio drives. ¹Blind protection function can respond in the event of wind loads (for textile sun protection)



works with
Yubii Home

elero head – radio control

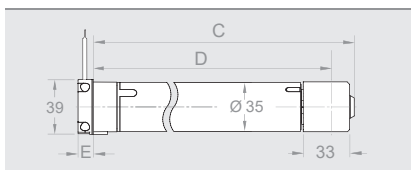

White head	 S1,5/70 -868	S3/30 -868	S5/30 -868
Item number	30 222.0006	30 212.0006	30 232.0006

Black head	 S5 -868	S8 -868	S10 -868 FL	S12 -868 FL	S12/11 -868 FL
Item number	30 234.0006	30 254.0006	30 824.0006	30 814.0006	30 812.0006

Technical data

Rated torque (Nm)	1,5	3	5
Rated speed (rpm)	70	30	30
Rated voltage (V)	1 ~ 230	1 ~ 230	1 ~ 230
Rated frequency (Hz)	50	50	50
Noiseless soft brake	•	•	•
High-speed version	•	•	•
Rated current (A)	0.55	0.55	0.73
Rated power consumption (W)	130	130	168
Operating time (min. S2)	5	5	4
Length C (mm)	534	534	534
Length D (mm)	517.5	517.5	517.5
Length E (mm)	11	11	11
Weight (kg)	1.3	1.2	1.3

Technical data

Rated torque (Nm)	5	8	10	12	12
Rated speed (rpm)	17	17	17	17	11
Rated voltage (V)	1 ~ 230	1 ~ 230	1 ~ 230	1 ~ 230	1 ~ 230
Rated frequency (Hz)	50	50	50	50	50
Noiseless soft brake	•	•	–	–	–
High-speed version	–	–	–	–	–
Rated current (A)	0.55	0.73	0.6	0.73	0.6
Rated power consumption (W)	130	168	140	168	140
Operating time (min. S2)	5	4	4	4	4
Length C (mm)	534	534	514	534	514
Length D (mm)	517.5	497.5	517.5	517.5	497.5
Length E (mm)	11	11	11	11	11
Weight (kg)	1.2	1.3	1.2	1.3	1.2

Accessories, such as connection and assembly cables, adapter sets, motor bearings and adapter plates, can be found in the section “RevolLine S accessories” on page 36. Suitable control systems and radio transmitters and sensors can be found in the section “Home automations” from page 138.

RoTop S

Tubular drives for roller shutters and textile sun protection¹



Mechatronic end position detection with soft cut-out, intelligent force measurement, upward/downward blind protection and free travel, end positions adjustable with assembly cable, parallel connection possible.
¹ Blind protection function can respond in the event of wind loads (for textile sun protection)

elero head – wired

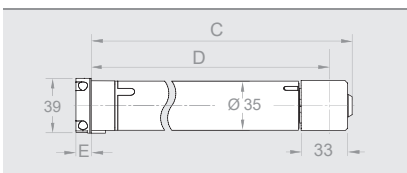

White head	S1,5/70	S3/30	S5/30
Item number	30 221.0001	30 211.0001	30 231.0001

Black head	S5	S8	S10 FL	S12 FL	S12/11 FL
Item number	30 233.0001	30 253.0001	30 823.0001	30 813.0001	30 811.0001

Technical data

Rated torque (Nm)	1,5	3	5
Rated speed (rpm)	70	30	30
Rated voltage (V)	1 ~ 230	1 ~ 230	1 ~ 230
Rated frequency (Hz)	50	50	50
Noiseless soft brake	•	•	•
High-speed version	•	•	•
Rated current (A)	0.55	0.55	0.73
Rated power consumption (W)	130	130	168
Operating time (min. S2)	5	5	4
Length C (mm)	534	534	534
Length D (mm)	517.5	517.5	517.5
Length E (mm)	11	11	11
Weight (kg)	1.3	1.2	1.3

Technical data

Rated torque (Nm)	5	8	10	12	12
Rated speed (rpm)	17	17	17	17	11
Rated voltage (V)	1 ~ 230	1 ~ 230	1 ~ 230	1 ~ 230	1 ~ 230
Rated frequency (Hz)	50	50	50	50	50
Noiseless soft brake	•	•	-	-	-
High-speed version	-	-	-	-	-
Rated current (A)	0.55	0.73	0.6	0.73	0.6
Rated power consumption (W)	130	168	140	168	140
Operating time (min. S2)	5	4	4	4	4
Length C (mm)	534	534	514	534	514
Length D (mm)	517.5	497.5	517.5	517.5	497.5
Length E (mm)	11	11	11	11	11
Weight (kg)	1.2	1.3	1.2	1.3	1.2

Accessories, such as connection and assembly cables, adapter sets, motor bearings and adapter plates, can be found in the section "RevoLine S accessories" on page 36. Suitable control systems, transmitters and sensors can be found in the section "Control systems" from page 214.

RolTop/D+ S-868

RolTop/D+ S

Tubular drives for roller shutters

Mechatronic end position detection with soft cut-out, intelligent force measurement, upward/downward blind protection and free travel, self-learning end positions with release function, parallel connection possible (for wired drives), bidirectional radio (868 MHz) with automatic routing function and feedback for radio drives.



works with
Yubii® Home¹

Only in conjunction with rigid shaft connectors!

elero head – radio control

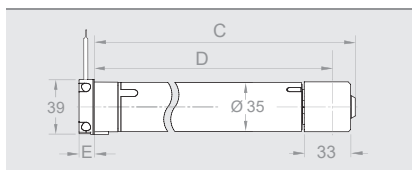

elero head – wired

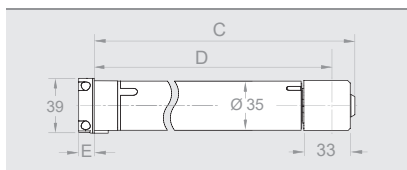

Black head	 D+ S5 -868	D+ S8 -868	D+ S12 -868
Item number	30 238.0006	30 258.0006	30 818.0006

Black head	 D+ S5	D+ S8	D+ S12
Item number	30 237.0001	30 257.0001	30 817.0001

Technical data

Rated torque (Nm)	5	8	12
Rated speed (rpm)	17	17	17
Rated voltage (V)	1 ~ 230	1 ~ 230	1 ~ 230
Rated frequency (Hz)	50	50	50
Noiseless soft brake	•	•	–
High-speed version	–	–	–
Rated current (A)	0.55	0.55	0.73
Rated power consumption (W)	130	130	168
Operating time (min. S2)	5	4	4
Length C (mm)	534	534	534
Length D (mm)	517.5	517.5	517.5
Length E (mm)	11	11	11
Weight (kg)	1.3	1.3	1.3

Accessories, such as connection and assembly cables, adapter sets, motor bearings and adapter plates, can be found in the section “RevolLine S accessories” on page 36. Suitable control systems and radio transmitters and sensors can be found in the section “Home automations” from page 138.

¹ 868 versions only

RoITop/T S-868

Radio tubular drives for dual screen

Mechatronic end position detection with soft cut-out, jog/rest mode, intelligent force measurement, upward/downward blind protection and free travel, end positions adjustable with assembly cable or hand-held transmitter, min. shaft size $\varnothing = 38 \text{ mm}$, noiseless soft brake, bidirectional radio control (868 MHz) with automatic feedback and routing function.



works with
Yubii Home

elero head – radio control

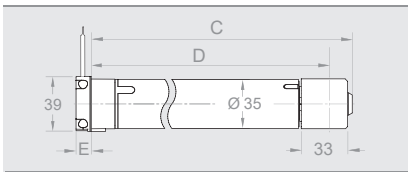

White head	T S1,5/70 -868	T S3/30 -868	T S5/30 -868
Item number	30 226.0006	30 216.0006	30 236.0006

Technical data

Rated torque (Nm)	1,5	3	5
Rated speed (rpm)	70	30	30
Rated voltage (V)	1 ~ 230	1 ~ 230	1 ~ 230
Rated frequency (Hz)	50	50	50
Noiseless soft brake	•	•	•
High-speed version	•	•	•
Rated current (A)	0.55	0.55	0.73
Rated power consumption (W)	130	130	168
Operating time (min. S2)	5	5	4
Length C (mm)	534	534	534
Length D (mm)	517.5	517.5	517.5
Length E (mm)	11	11	11
Weight (kg)	1.3	1.2	1.3

Accessories, such as connection and assembly cables, adapter sets, motor bearings and adapter plates, can be found in the section “RevoLine S accessories” on page 36. Suitable control systems as well as radio transmitters and sensors can be found in the section “Home automations” from page 138.

SunTop S-868 / SunTop S



The SunTop S-868 / SunTop S tubular drives of the S series for small window awnings and roller blinds are available both with and without an integrated radio system. Where noise is particularly disturbing, drives with noiseless soft brakes can be used.

In addition, the drives are equipped with blockage detection and intelligent force measurement. With a diameter of 35 mm, the drives are ideally designed for space-saving systems. 5 to 7 Nm and 30 rpm are available.

SunTop S drives are available with different drive heads:

White drive head

- Up to 5 Nm
- Suitable for RevoLine motor bearings in conjunction with a motor bearing or intermediate plate

Radio control



Wired



Black drive head

- From 5 Nm
- Suitable for RevoLine motor bearings in conjunction with a motor bearing or intermediate plate



Bidirectional routing with ProLine 2



ProLine 2, the bidirectional radio system from elero, is more reliable, powerful and transparent than unidirectional radio standards. At the heart of the technology (868 MHz) are bidirectional radio components

(transceivers) that are capable not only of receiving, but also of confirming and relaying the signals. As soon as a command has been executed on the drive, the user receives feedback and can be sure that the commands are being executed correctly.



Applications	SunTop S-868 SunTop S
Page	30/31
Textile sun protection	•

TOP functions	SunTop S-868 SunTop S
Special features	High-speed version
Mechatronic limit position detection with soft cut-out	•
Intelligent force measurement	•
Blocking recognition	•
End positions can be set with assembly cable and/or hand-held transmitter	•
Noiseless soft brake (up to 5 Nm)	•
Parallel connection possible (wired version only)	•

** only for 868 MHz radio drives*

Technical data	SunTop S-868 SunTop S
Rated torque (Nm)	5 and 7
Rated speed (rpm)	30
Min. shaft diameter (mm)	38
Diameter (mm)	35
Length (mm)	545
Noiseless soft brake (up to 5 Nm)	•
Protection class (IP)	44
Limit switch range (rev.)	40, 80
Ambient operating temperature (°C)	-20 to +60
Conformity	
Plug-in connection cable, 2.0 m	•

End position programming		SunTop S-868 SunTop S
Top	Bottom	
To stop	Freely adjustable	•
Freely adjustable	To stop	•
To stop	To stop	•
Freely adjustable	Freely adjustable	•

SunTop S-868

Radio tubular drives for textile sun protection



works with
Yubii® Home

Mechatronic end position detection with soft cut-out, intelligent force measurement, blocking detection, end positions adjustable with assembly cable or hand-held transmitter, min. shaft size $\varnothing = 38$ mm, noiseless soft brake up to 5 Nm, bidirectional radio (868 MHz) with automatic routing function and feedback.

elero head – radio control

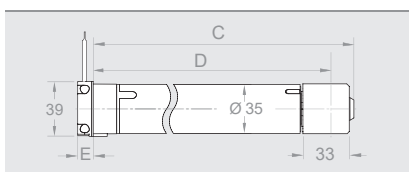

White head		S5/30 -868
Item number		30 732.0006

Black head		S7/30 -868 FL
Item number		30 752.0006

Technical data	
Rated torque (Nm)	5
Rated speed (rpm)	30
Rated voltage (V)	1 ~ 230
Rated frequency (Hz)	50
Noiseless soft brake	•
High-speed version	•
Rated current (A)	0.73
Rated power consumption (W)	168
Operating time (min S2)	4
Length C (mm)	534
Length D (mm)	517.5
Length E (mm)	11
Weight (kg)	1.3

Technical data	
Rated torque (Nm)	7
Rated speed (rpm)	30
Rated voltage (V)	1 ~ 230
Rated frequency (Hz)	50
Noiseless soft brake	–
High-speed version	•
Rated current (A)	0.73
Rated power consumption (W)	168
Operating time (min S2)	4
Length C (mm)	534
Length D (mm)	517.5
Length E (mm)	11
Weight (kg)	1.4

Accessories, such as connection and assembly cables, adapter sets, motor bearings and adapter plates, can be found in the section “RevoLine S accessories” on page 36. Suitable control systems and radio transmitters and sensors can be found in the section “Home automations” from page 138.

SunTop S

Tubular drives for textile sun protection



Mechatronic end position detection with soft cut-out, intelligent force measurement, blocking detection, end positions adjustable with assembly cable, min. shaft size $\varnothing = 38$ mm, noiseless soft brake up to 5 Nm, parallel connection possible.

elero head – wired

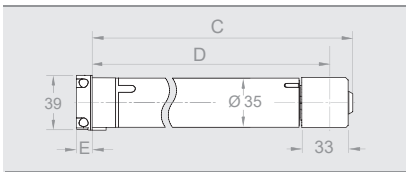

White head		S5/30
Item number		30 731.0001

Black head		S7/30 FL
Item number		30 751.0001

Technical data	
Rated torque (Nm)	5
Rated speed (rpm)	30
Rated voltage (V)	1 ~ 230
Rated frequency (Hz)	50
Noiseless soft brake	•
High-speed version	•
Rated current (A)	0.73
Rated power consumption (W)	168
Operating time (min S2)	4
Length C (mm)	534
Length D (mm)	517.5
Length E (mm)	11
Weight (kg)	1.3

Technical data	
Rated torque (Nm)	7
Rated speed (rpm)	30
Rated voltage (V)	1 ~ 230
Rated frequency (Hz)	50
Noiseless soft brake	–
High-speed version	•
Rated current (A)	0.73
Rated power consumption (W)	168
Operating time (min S2)	4
Length C (mm)	534
Length D (mm)	517.5
Length E (mm)	11
Weight (kg)	1.4

Accessories, such as connection and assembly cables, adapter sets, motor bearings and adapter plates, can be found in the section “RevoLine S accessories” on page 36. Suitable control systems can be found in the section “Control systems” from page 214.

VariEco S-868 / VariEco S



VariEco S-868 / VariEco S tubular drives of the S series for roller shutters and textile sun protection are available both without and with an integrated radio system. With a diameter of 35 mm, the drives are ideally designed for space-saving systems. In addition, the VariEco S-K

drive impresses with its short design. 1.5 to 12 Nm and 42 rpm are available. Where noise is particularly disturbing, drives with noiseless soft brakes can be used. All drives can be easily installed and adjusted in a time-saving manner.

VariEco S drives are available with different drive heads:

White drive head

- Up to 5 Nm
- Suitable for RevoLine motor bearings in conjunction with a motor bearing or intermediate plate

Radio control



Wired



Black drive head

- Min. 5 Nm
- Suitable for RevoLine motor bearings in conjunction with a motor bearing or intermediate plate



White drive head for VariEco S-K

- Connection cable not interchangeable
- Short design



Bidirectional routing with ProLine 2



ProLine 2, the bidirectional radio system from elero, is more reliable, powerful and transparent than unidirectional radio standards. At the heart of the technology (868 MHz) are bidirectional radio components (transceivers) that are capable

not only of receiving, but also of confirming and relaying the signals. As soon as a command has been executed on the drive, the user receives feedback and can be sure that the commands are being executed correctly.



Applications	VariEco S-868 VariEco S	VariEco S-868 VariEco S high-speed version	VariEco S-K	VariEco S-K high-speed version
Page	34	34	35	35
Roller shutters	•	•	•	•
Textile sun protection	•	•	•	•

TOP functions	VariEco S-868 VariEco S	VariEco S high-speed version	VariEco S-K	VariEco S-K high-speed version
Mechanical limit switch	•	•	•	•
Short design			•	•

Technical data	VariEco S-868 VariEco S	VariEco S-868 VariEco S high-speed version	VariEco S-K	VariEco S-K high-speed version
Rated torque (Nm)	5 to 12	1.5 to 5	5	1,2 and 3
Rated speed (rpm)	11 and 17	30 and 70	17	30 and 70
Rated frequency (Hz)	50	50	50	50
Min. shaft diameter (mm)	38	38	38	38
Diameter (mm)	35	35	35	35
Length (mm)	from 525	545	421	421
Noiseless soft brake (up to 8 Nm)	• <i>(not VariEco FL / -868)</i>	•	•	•
Protection class (IP)	44	44	44	44
Limit switch range (rev.)	42	42	33	33
Ambient operating temperature (°C)	-20 to +60	-20 to +60	-20 to +60	-20 to +60
Conformity				
Plug-in connection cable, 2.0 m	•	•	3.0 m not interchangeable	3.0 m not interchangeable

End position programming		VariEco S-868 VariEco S	VariEco S-868 VariEco S high-speed version	VariEco S-K	VariEco S-K high-speed version
Top	Bottom				
Freely adjustable*	Freely adjustable*	•	•	•	•

* Mechanical

VariEco S-868 / VariEco S

Tubular drives for roller shutters and textile sun protection



Mechanical limit switch, min. shaft size $\varnothing = 38$ mm, noiseless soft brake up to 8 Nm, bidirectional radio (868 MHz) with automatic feedback and routing function (with radio drives).

elero head – radio control

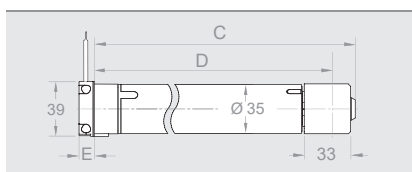

elero head – wired

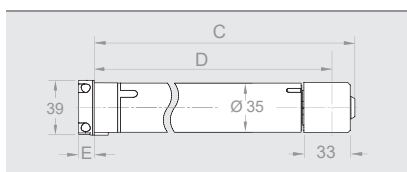

Head white	S1.5/70 -868	S3/30 -868	S5/30 -868
Item number	30 922.0106	30 912.0106	30 932.0106

Head black	S5 -868 FL	S8 -868	S8 -868 FL	S12 -868 FL
Item number	30 844.0106	30 954.0106	30 854.0106	30 864.0106

Head white	S1.5/70	S3/30	S5/30	S5/30 FL
Item number	30 921.0101	30 911.0101	30 931.0101	30 831.0101

Head black	S5 FL	S8	S10 FL	S12 FL	S12/11 FL
Item number	30 843.0101	30 953.0101	30 873.0101	30 863.0101	30 855.0101

Technical data

Rated torque (Nm)	1.5	3	5	5
Rated speed (Upm)	70	30	30	30
Rated voltage (V)	1 ~ 230	1 ~ 230	1 ~ 230	1 ~ 230
Rated frequency (Hz)	50	50	50	50
Noiseless soft brake	•	•	•	–
High-speed version	•	•	•	•
Rated current (A)	0,55	0,55	0,73	0,6
Rated power consumption (W)	130	130	168	140
Operating time (min S2)	5	5	4	4
Length C (mm)	534	534	534	514
Length D (mm)	517,5	517,5	517,5	497,5
Length E (mm)	11	11	11	11
Weight (kg)	1,3	1,3	1,3	1,2

Technical data

Rated torque (Nm)	5	8	10	12	12
Rated speed (Upm)	17	17	17	17	11
Rated voltage (V)	1 ~ 230	1 ~ 230	1 ~ 230	1 ~ 230	1 ~ 230
Rated frequency (Hz)	50	50	50	50	50
Noiseless soft brake	–	•	–	–	–
High-speed version	–	–	–	–	–
Rated current (A)	0.60	0.73	0.6	0.73	0.6
Rated power consumption (W)	140	168	140	168	140
Operating time (min S2)	4	4	4	4	4
Length C (mm)	514	534	514	534	514
Length D (mm)	497.5	517.5	497.5	517.5	497.5
Length E (mm)	11	11	11	11	11
Weight (kg)	1,3	1,3	1,3	1,4	1,2

Accessories, such as connection and assembly cables, adapter sets, motor bearings and adapter plates, can be found in the section “RevolLine S accessories” on page 36. Suitable control systems can be found in the section “Home automations” from page 138.

VariEco S-K

Tubular drives for roller shutters and textile sun protection



Mechanical limit switch, short design, min. shaft size $\varnothing = 38$ mm, noiseless soft brake, 3.0 m connection cable (not replaceable).

elero head – wired

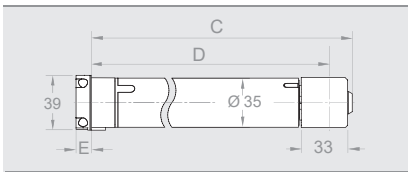

Head white	S1.2/70-K	S3/30-K	S5-K
Item number	30 971.0101	30 991.0101	30 981.0101

Technical data

Rated torque (Nm)	1.2	3	5
Rated speed (Upm)	70	30	17
Rated voltage (V)	1 ~ 230	1 ~ 230	1 ~ 230
Rated frequency (Hz)	50	50	50
Noiseless soft brake	•	•	•
High-speed version	•	•	–
Rated current (A)	0.52	0.52	0.52
Rated power consumption (W)	120	120	120
Operating time (min S2)	4	4	4
Length C (mm)	410	410	410
Length D (mm)	393	393	393
Length E (mm)	11	11	11
Weight (kg)	1.2	1.2	1.2

Accessories, such as connection and assembly cables, adapter sets, motor bearings and adapter plates, can be found in the section “RevoLine S accessories” on page 36. Suitable control systems can be found in the section “Wall-mounted devices” from page 214.

Cables and accessories

The return of connecting cables is not possible!



23 395.0201

Connection cable without drive, **white**

Item number	Type/Item Description
23 615.2501	0.2 m pluggable
23 395.0201	2.0 m pluggable
23 395.0301	3.0 m pluggable
23 395.0401	5.0 m pluggable
23 395.0501	10.0 m pluggable
23 395.0901	15.0 m pluggable
23 395.0601	20.0 m pluggable
23 395.2601	QuickConnect with MiniPlug, IP 65 Cable length of 0.25 m
23 395.0101	0.4 m, pluggable with Hirschmann plug STAS3, light grey, moulded on
23 395.0801	2.0 m pluggable with Hirschmann plug STAS3, light grey, screwed on

Assembly and connection cables and accessories

Item number	Type/Item Description
23 395.8502	Assembly cable with 4-pin terminal
13 710.5101	Quick clamp as replacement for assembly cable 23 395.8501
23 285.1201	Cable adapter, 0.25 m, 4-core/ STAK3
23 395.2701	QuickConnect, quick connection system, IP 65
23 395.4701	QuickConnect, set of 10
23 846.0001	Hirschmann plug STAS3 (motor side), light grey with clip
13 701.5301	Hirschmann coupling STAK3 (connection side), light grey
23 999.1001	Hirschmann plug STAS3 (motor side), with clip, black
13 703.1001	Hirschmann plug STAK3 (connection side), black
13 308.0001	Flexible adjustment aid
23 375.6001	Wire jumper for Hirschmann plug for radio motors
13 308.4201	Rubber grommet

Cable extensions with Hirschmann STAS3 can be found on page 116!



23 395.0101

Connection cable without drive, **black**

Item number	Type/Item Description
23 395.6101	0.5 m pluggable halogen-free
23 395.2201	2.0 m pluggable
23 395.2301	3.0 m pluggable
23 395.9301	3.0 m pluggable halogen-free
23 395.2401	5.0 m pluggable
23 395.9401	5.0 m pluggable halogen-free
23 395.2501	10.0 m pluggable
23 395.9501	10.0 m pluggable halogen-free
23 395.4001	10,0 m pluggable halogen-free with grommet
23 395.2101	0.4 m, pluggable with Hirschmann plug STAS3, light grey, moulded on
23 395.8101	0.4 m, pluggable with Hirschmann plug STAS3, light grey, moulded on, halogen-free
23 395.2901	2.0 m, pluggable with Hirschmann plug STAS3, black, screwed on



23 395.8502

23 285.1201



13 308.0001

23 395.2701

23 395.2601

Assembly and disassembly must be carried out only in a de-energised state! The connections to the 230 V mains must be made by authorised specialist personnel.

Drive adapters

Profiles of the adapter sets in 1:1 scale can be found on page 254.



Item number	Type/Item Description	Notch tubes	Round tubes	Profile tubes
22 017.0001	Ø 52 x 1.5 mm	•		
22 004.0001	Ø 63 x 1.0 mm	•		
22 011.0001	Ø 40 x 1.0 mm		•	
22 009.0001	Ø 40 x 1.5 mm		•	
13 101.5301	Ø 40 x 1.5 mm (limit switch crown only), white for interior roller blind application		•	
13 119.0301	Ø 40 x 1.5 mm (coupling only)		•	
13 119.0601	Ø 40 x 2.0 mm (coupling only), Ø 38 x 1.0 mm		•	
22 015.0001	Ø 42 x 1.0 mm		•	
22 071.0001	Ø 50 x 1.5 mm		•	
22 016.0001	Ø 50 x 2.0 mm, Italy		•	
22 010.0001	For octagonal, size 40, aluminium tube, Selve			•
23 097.0001	For aluminium profile tube, Ø 42 mm, Silentgliss			•
22 013.0001	Ø 42 x 2.0 mm, Bautex, Sundrape			•
22 018.0001	Ø 43.5 mm, Tecnolight/Acmeda, Ø 44 mm, Garattoni			•
22 083.0001	Ø 43 mm, Spain			•
22 014.0001	Ø 45 mm, Zurflüh-Feller ZF 45			•
22 068.0001	Ø 47 mm			•
22 002.0001	AXE Ø 48 mm, Griesser-Hüppe			•
22 006.0001	Für 8-kant, SW 50 Selve			•
22 007.0001	Ø 50 x 1.5 mm, Siral			•
22 012.0001	Ø 50 mm, Alu			•
22 054.0001	Ø 50 mm, Alu, Latin America			•
22 084.0001	Ø 53 mm, Spain			•
22 008.0001	54 x 0.5 mm, Zurflüh-Feller			•
22 135.0001	55 x 1.5 mm profile tube, Weinor (coupling only)			•
22 005.0001	60 mm, octagonal, Selve, Döhner			•
10 111.0296	Rubber circlip for motor coupling, 2 mm			
10 111.0264	Rubber circlip, reinforced for motor coupling, 2.7 mm			
13 300.9701	RevoLine metal clip for motor coupling			
13 121.3001	Adapter ring for using S drives with M adapter sets			
23 028.0001	Adapter for Somfy adapter set, max. 40 Nm (suitable for Somfy and Simu, 50 mm motor couplings)			
13 115.9901	Coupling remover			

RevoLine motor adapter plates



99 000.7501

To use S-motor in RevoLine bearing (see below). Order with this number so that the plate is mounted on the ordered motor.

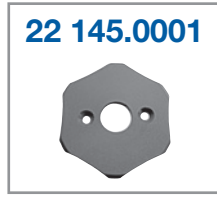

22 145.0001

Like number 99 000.7501, as retrofit or spare part for existing drive.

RevoLine motor bearing in conjunction with motor bearing plate

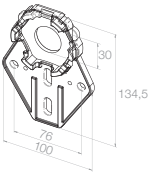

23 004.0001
Universal motor bearing (plastic), torque limitation, max. 50 Nm

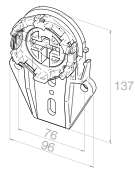

23 615.4401
Universal motor bearing, disengageable, torque limitation, max. 30 Nm

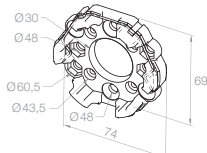

23 003.0001
Pitch circle 48/60 (aluminium) with 4 x M6 nuts

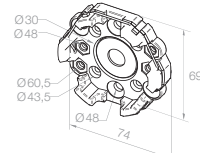

23 003.0201
Pitch circle 48/60 (aluminium) with 4 x M6 nuts and centring

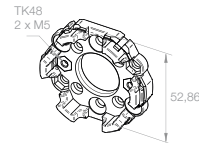

23 003.0401
Pitch circle of 48 mm with 2 x M5 nuts, pitch circle of 60 mm

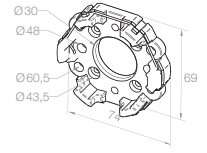

23 003.0301
Pitch circle 48/60 with M6/M8 thread - for awnings -

SKS

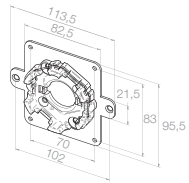

23 004.0101
Motor bearing for SKS torque limitation Max. 50 Nm

With base plate

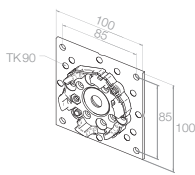

23 615.9901
Base plate with motor bearing, e.g. for VEKA variant elements

With mounting plate

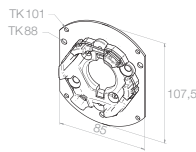

23 615.7101
Mounting plate with plastic bearing up to max. 30 Nm (Thyssen, Schüco, Veka, Home)

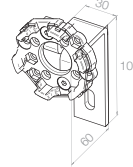

23 615.9101
Motor bearing, cranked, up to max. 50 Nm (60 mm wall distance)

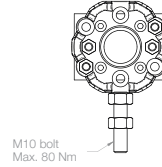

23 615.3501
Special bolt bearing with height adjustment with M10 bolt, max 80 Nm

Clamp bearing

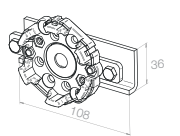

23 615.7201
Clamp bearing for roller bearing bracket, torque limitation up to max. 30 Nm

Screwless, left

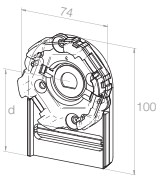

23 615.8201
For built-in roller shutters, size 137 mm, d = 64 - 65.5 mm, up to max. 30 Nm

Screwless, right

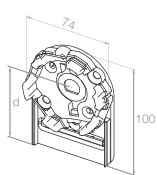

23 615.9201
For built-in roller shutters, size 137 mm, d = 64 - 65.5 mm, up to max. 30 Nm

Screwless, left

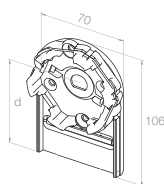

23 615.8301
For built-in roller shutters, size 150 mm, d = 70.7 mm, up to max. 30 Nm

Screwless, right

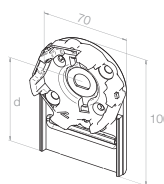

23 615.9301
For built-in roller shutters, size 150 mm, d = 70.7 mm, up to max. 30 Nm

Screwless, left

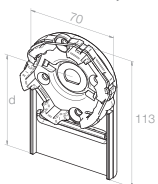

23 615.8401
For built-in roller shutters, size 165 mm, d = 78.2 - 79.7 mm, up to max. 30 Nm

Screwless, right

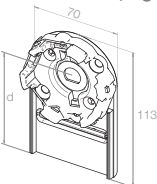

23 615.9401
For built-in roller shutters, size 165 mm, d = 78.2 - 79.7 mm, up to max. 30 Nm

Screwless Left + right



23 003.1601
For Heroal elements FMR/FME/FMB Size 125-205 mm up to max. 30 Nm

Screwless, left



23 003.1501
For Heroal elements FMR/FME/FMB Size 125-205 mm

Screwless, right



23 003.1401
For Heroal elements FMR/FME/FMB Size 125-205 mm

Motor adapter plates – intermediate plates



99 000.7401
To use S-motor in the bearings below. Order with this number so that the plate is mounted on the ordered motor.



22 141.0001
Like number 99 000.7501, as retrofit or spare part for existing drive.



22 144.0001
Like number 99 000.7401, in white. As retrofit or spare part for existing drive.

Motor bearing in conjunction with intermediate plate

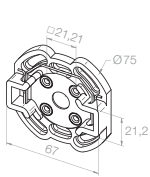

23 322.0001
Motor bearing
Pitch circle 48 and 60
With oblong hole

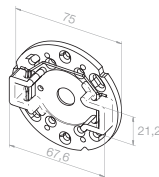

23 108.0001
Motor bearing
Pitch circle 48 and 60

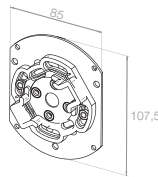

23 277.0001
With motor bearing
(Thyssen, Schüco, Brüggmann)

Intermediate, motor bearing and adapter plates

Motor bearing plate set

Intermediate plates

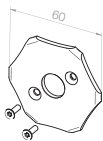

22 145.0001
For use with RevoLine wall bearings

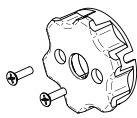

23 375.9001²
Motor bearing plate set for use in star head bearing (Somfy compatible)

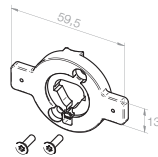

22 141.0001
Orange, complete, incl. mounting accessories

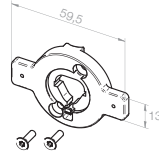

22 144.0001
White, complete, incl. mounting accessories

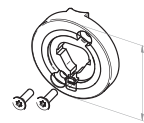

22 140.0001
Without leaf, orange, complete, incl. mounting accessories

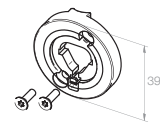

22 042.0001
Without leaf, white, complete. Incl. mounting accessories

Intermediate plate

Set of intermediate plates

End piece *

Adapter *

Square bolt *

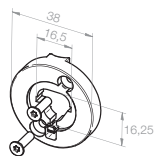

22 042.0101
Without leaf, white, complete, incl. mounting accessories with long screws for use with following metal adapter plates

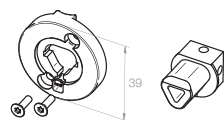

22 143.0001³
16 x 16 mm (incl. white intermediate plate and mounting accessories), can be used up to 5 Nm

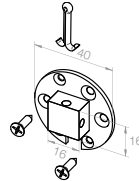

23 367.0001³
16 x 16 mm, complete

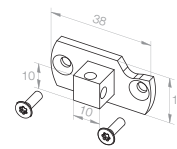

22 040.0001
10 x 10 mm, complete, incl. accessories

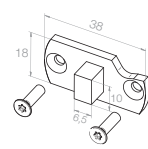

23 099.0001
With 10 x 6.5 mm bolt (11 mm high) incl. fixing screws

Bearing plates *

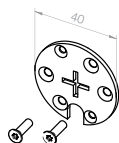

22 064.0001
Cross = 13 mm
Complete, incl. mounting accessories

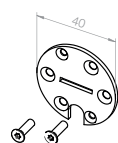

22 065.0001
Slot = 16.4 mm
Complete, incl. mounting accessories

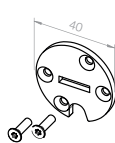

22 080.0001
(15 x 3 mm slot), Benthin incl. mounting accessories

Only the accessory plates marked with * are suitable for VariEco S-K drives.

² Compatible bearings on page 77

³ Compatible bearings on page 40 and page 79

Wall bearings/mounting plates

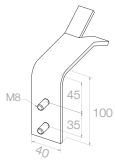

13 300.9202
Plaster bearings up to max. 80 Nm

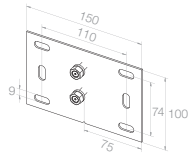

24 554.0001
Mounting plate for universal bearing (23 004.0001 and 23 615.4401)

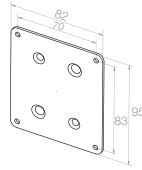

13 302.2601
Mounting plate for motor bearing (Stakusit)

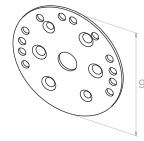

13 302.7801
Mounting plate for motor bearing, pitch circle of 78 mm
E.g. for Weru elements

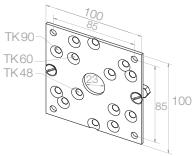

23 687.0501
Base plate with 2 retractable M6 x 16 screws and nuts

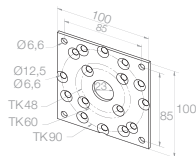

13 109.2902
Base plate with 48/60/90 mm pitch circle (without motor bearing and screws)

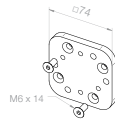

23 687.0401
Spacer plate, aluminium, black, with 2x M6 x 14 mm

Fixing clips

Angle bracket

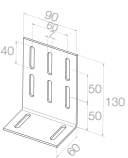

13 110.5101
130 mm high

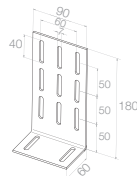

13 110.5201
180 mm high

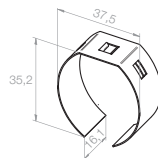

13 301.8201
For T-spring
40 mm, octagonal shaft

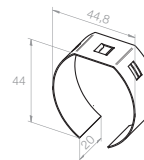

13 301.8501
For T-spring
50 mm, octagonal shaft

Hochschiebesicherungen

Miniprofil anti push-up devices

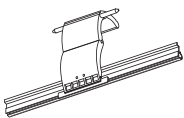

13 301.8901
2-membered

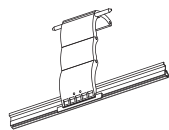

13 301.9101
3-membered

Attachment rings

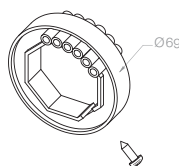

13 301.9401
For 40 mm octagonal shaft

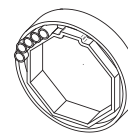

13 302.1501
For 50 mm Octagonal shaft

MiniClick and MaxiClick rigid shaft connectors

Universal for size 40, 50, 60 and 70 octagonal shafts



MiniClick, with twist lock

For mini profiles and octagonal shafts, size 40, 50 (0.6 and 0.8 mm) and size 60 (0.6 and 0.9 mm)

Item number	Type/Item Description
13 309.0001	MiniClick, 1-membered
13 309.0101	MiniClick, 2-membered
13 309.0201	MiniClick, 3-membered
13 309.0301	MiniClick, 4-membered
13 309.0401	MiniClick slide-in profile
13 309.0501	MiniClick compensation profile

MaxiClick, with twist lock

For standard/new construction profiles and octagonal shafts, size 60 (0.9 mm) and size 70 (1.0/1.2 and 1.5 mm)

Item number	Type/Item Description
13 309.1001	MaxiClick, 1-membered
13 309.1101	MaxiClick, 2-membered
13 309.1201	MaxiClick, 3-membered
13 309.1401	MaxiClick slide-in profile
13 309.1501	MaxiClick compensation profile

Determination of the suitable MiniClick shaft connector

Shaft connector	With box depth B1 (mm)	Number per blind	Blind weight (kg)	Application range
1-membered	115 – 150	One rigid shaft connector per 60 cm shaft length or per 4 Nm motor output	Max. 8 per shaft connector	Mini/Maxi profile ¹
2-membered	155 – 180			
3-membered	185 – 210			
4-membered	215 – 240			

Determination of the suitable MaxiClick shaft connector

Shaft connector	With box depth B1 (mm)	Number per blind	Blind weight (kg)	Application range
1-membered	125 – 160	One rigid shaft connector per 60 cm shaft length or per 6 Nm motor output	Max. 12 per shaft connector	Mini/Maxi profile ¹
2-membered	160 – 200			
3-membered	200 – 250			

¹ Values depend, among other things, on the shaft type.

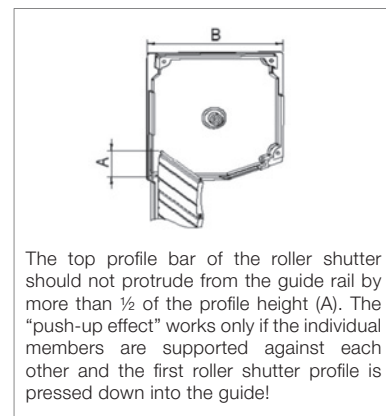

elero

RevoLine M Tubular drives

RoIMotion M /-868	46.
RoIMotion/D+ M /-868	48.
RoITop M /-868	52.
RoITop/D+ M /-868	56.
RoITop/D+ M NHK	57.
RoITop M s_onro /-868	58.
RoITop/J M /-868	59.
SunTop M /-868	62.
SunTop/Z M /-868	64.
VariEco M / VariEco+ M	68.
VariEco M NHK	70.
RevoLine M accessories	72.

RoIMotion M-868 / RoIMotion M



RoIMotion drives from elero ensure slower and quieter movement of motorised roller shutters thanks to their optimised running behaviour. In addition to proven technologies, such as the soft brake and obstacle and blockage detection, quiet mode offers you even greater living comfort at minimum noise pollution. The RoIMotion M-868 and M tubular drives are available both with and without an integrated radio system. They have a diameter of 45 mm and a minimum length of 478 mm.

Configurations of 6 to 25 Nm and, depending on the version, 5 to 14 rpm are available. All drives can be easily installed and adjusted in a time-saving manner. With the RH and SH tubular drives, the range of applications of the M series has been further expanded. The main feature of RH drives is that the round head can be wound over, which significantly reduces the space required on the side. Drives of the SH series (star motor head) fit, among others, in motor bearings of various competitors.

RoIMotion M drives are available with different drive heads:

elero head

- Small deduction dimension
- Suitable for all RevoLine motor bearings from elero

Radio control

Wired



RH head (round head)

- Tubular drive with wrap-around round motor head
- Very small deduction dimension
- Individually deployable



SH head (star head)

- Tubular drive with star motor head
- Suitable for common star motor bearings



Bidirectional routing with ProLine 2



ProLine 2, the bidirectional radio system from elero, is more reliable, powerful and transparent than unidirectional radio standards. At the heart of the technology (868 MHz) are bidirectional radio components

(transceivers) that are capable not only of receiving, but also of confirming and relaying the signals. As soon as a command has been executed on the drive, the user receives feedback and can be sure that the commands are being executed correctly.



Applications	RoIMotion M-868 RoIMotion M	RoIMotion/D+ M-868 RoIMotion/D+ M
Page	46/47	48/49
Roller shutters	•	•

TOP functions	RoIMotion M-868 RoIMotion M	RoIMotion/D+ M-868 RoIMotion/D+ M
Special features	End positions freely adjustable	Plug & play / self-learning end positions
Mechatronic end position detection with soft cut-out	•	•
Quiet mode	•	•
Long runtime (10 Min.)	•	•
Intelligent force measurement	•	•
Upward/downward blind protection and free travel	•	•
Self-learning end positions with release function		•
End positions freely adjustable	•	
Parallel connection possible (up to 3 drives) (wired version only)	•	•
Ventilation and intermediate position adjustable (radio drives)	•	•
Only in conjunction with rigid shaft connectors		•

Technical data	RoIMotion M-868 RoIMotion M	RoIMotion/D+ M-868 RoIMotion/D+ M
Rated torque (Nm)	6 to 25	6 to 25
Rated speed (Upm)	14	14
Rated speed in quiet mode (rpm)	5	5
Min. shaft diameter (mm)	50	50
Diameter (mm)	45	45
Length (mm)	from 478	from 478
Noiseless soft brake	•	•
Protection class (IP)	44	44
Limit switch range (rev.)	70	70
Ambient operating temperature (°C)	-20 to +60	-20 to +60
Conformity	CE	CE
Plug-in connection cable, 2.0 m	•	•

End position programming		RoIMotion M-868 RoIMotion M	RoIMotion/D+ M-868 RoIMotion/D+ M
Top	Bottom		
To stop	Freely adjustable	•	
Freely adjustable	To stop	•	
To stop	To stop	•	• <i>Self-learning end positions</i>
Freely adjustable	Freely adjustable	•	

RoIMotion M-868

Radio tubular drives for roller shutters with quiet mode



Mechatronic end position detection with soft cut-out, intelligent force measurement, upward/downward blind protection and free travel, automatic release for torque cut-off at end position, end positions adjustable with radio transmission or assembly cable, min. shaft size $\varnothing = 50$ mm, noiseless soft brake up to 5 Nm, bidirectional radio control (868 MHz) with automatic routing function and feedback.

works with
Yubii® Home

elero head – radio control

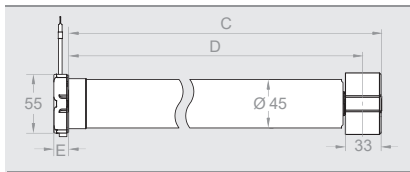

Round head RH – radio control

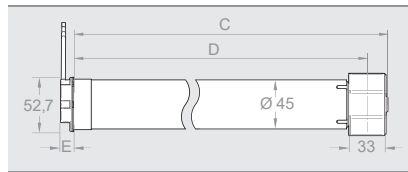

Star head SH – radio control

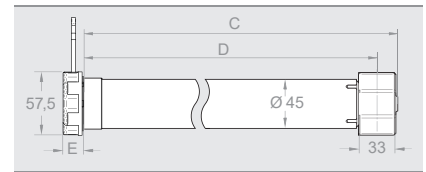

elero head	M6 -868	M10 -868	M20 -868	M25 -868
Item number	44 302.0001	44 222.0001	44 232.0001	44 242.0001

Round head	M6 -868 RH	M10 -868 RH	M20 -868 RH	M25 -868 RH
Item number	48 302.0001	48 222.0001	48 232.0001	48 242.0001

Star head	M6 -868 SH	M10 -868 SH	M20 -868 SH	M25 -868 SH
Item number	49 302.0001	49 222.0001	49 232.0001	49 242.0001

Technical data

Rated torque (Nm)	6	10	20	25
Rated speed (Upm)	14/5	14/5	14/5	14/5
Rated voltage (V)	1 ~ 230	1 ~ 230	1 ~ 230	1 ~ 230
Rated frequency (Hz)	50	50	50	50
Noiseless soft brake	•	•	•	•
Rated current (A)	0.4	0.5	0.8	1.1
Rated power consumption (W)	92	115	184	253
Operating time (min S2)	10	10	10	10
Length C (mm)	466	466	526	546
Length D (mm)	449	449	509	529
Length E (mm)	elero head = 14, round head = 12, star head = 19			
Weight (kg)	1.7	1.7	2.1	2.5

Accessories, such as connection and assembly cables, adapter sets and motor bearings, can be found in the section “RevoLine M accessories” on page 72.

Suitable control systems and radio transmitters and sensors can be found in the section “Home automations” on page 138.

RoIMotion M

Tubular drives for roller shutters with quiet mode



Mechatronic end position detection with soft cut-out, intelligent force measurement, upward/downward blind protection and free travel, automatic release for torque cut-off at end position, end positions adjustable with assembly cable, min. shaft size $\varnothing = 50$ mm, noiseless soft brake up to 25 Nm. Parallel connection with up to three drives possible.

elero head – wired

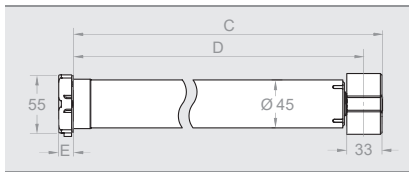

Round head RH – wired

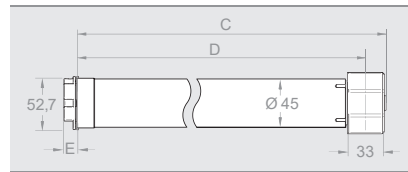

Star head SH – wired

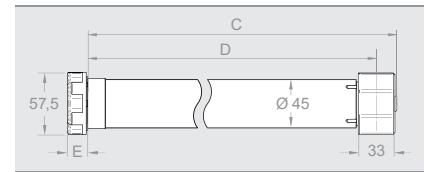

elero head	M6	M10	M20	M25
Item number	44 301.0001	44 221.0001	44 231.0001	44 241.0001

Round head	M6 RH	M10 RH	M20 RH	M25 RH
Item number	48 301.0001	48 221.0001	48 231.0001	48 241.0001

Star head	M6 SH	M10 SH	M20 SH	M25 SH
Item number	49 301.0001	49 221.0001	49 231.0001	49 241.0001

Technical data

Rated torque (Nm)	6	10	20	25
Rated speed (Upm)	14/5	14/5	14/5	14/5
Rated voltage (V)	1 ~ 230	1 ~ 230	1 ~ 230	1 ~ 230
Rated frequency (Hz)	50	50	50	50
Noiseless soft brake	•	•	•	•
Rated current (A)	0.4	0.5	0.8	1.1
Rated power consumption (W)	92	115	184	253
Operating time (min S2)	10	10	10	10
Length C (mm)	466	466	526	546
Length D (mm)	449	449	509	529
Length E (mm)	elero head = 14, round head = 12, star head = 19			
Weight (kg)	1.7	1.7	2.1	2.5

Accessories, such as connection and assembly cables, adapter sets and motor bearings, can be found in the section “RevoLine M accessories” on page 72. Suitable control systems can be found in the section “Wall-mounted devices” on page 214.

RoIMotion/D+ M-868

Radio tubular drives for roller shutters with quiet mode

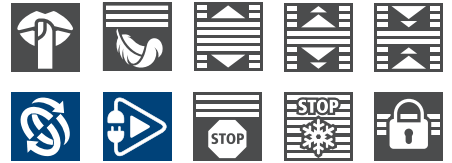

Mechatronic end position detection with soft cut-out, intelligent force measurement, upward/downward blind protection and free travel, automatic release for torque cut-off at end position, min. shaft size $\varnothing = 50$ mm, noiseless soft brake up to 25 Nm, bidirectional radio control (868 MHz) with automatic routing function and feedback.

works with **Yubii® Home**

Only in conjunction with rigid shaft connectors!

elero head – radio control

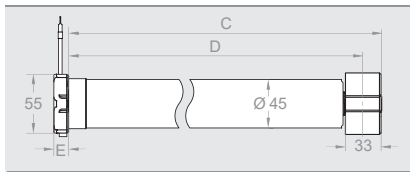

Round head RH – radio control

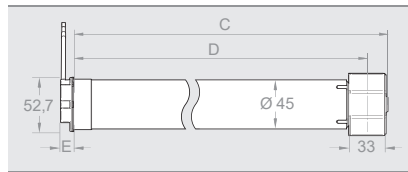

Star head SH – radio control

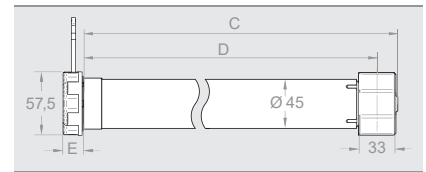

elero head		/D+ M6 -868	/D+ M10 -868	/D+ M20 -868	/D+ M25 -868
Item number		44 014.0001	44 024.0001	44 034.0001	44 044.0001
Round head		/D+ M6 -868 RH	/D+ M10 -868 RH	/D+ M20 -868 RH	/D+ M25 -868 RH
Item number		48 014.0001	48 024.0001	48 034.0001	48 044.0001
Star head		/D+ M6 -868 SH	/D+ M10 -868 SH	/D+ M20 -868 SH	/D+ M25 -868 SH
Item number		49 014.0001	49 024.0001	49 034.0001	49 044.0001

Technical data

Rated torque (Nm)	6	10	20	25
Rated speed (Upm)	14/5	14/5	14/5	14/5
Rated voltage (V)	1 ~ 230	1 ~ 230	1 ~ 230	1 ~ 230
Rated frequency (Hz)	50	50	50	50
Noiseless soft brake	•	•	•	•
Rated current (A)	0.4	0.5	0.8	1.1
Rated power consumption (W)	92	115	184	253
Operating time (min S2)	10	10	10	10
Length C (mm)	466	466	526	546
Length D (mm)	449	449	509	529
Length E (mm)	elero head = 14, round head = 12, star head = 19			
Weight (kg)	1.7	1.7	2.1	2.5

Accessories, such as connection and assembly cables, adapter sets and motor bearings, can be found in the section “RevoLine M accessories” on page 72. Suitable control systems and radio transmitters and sensors can be found in the section “Home automations” on page 138.

RoIMotion/D+ M

Tubular drives for roller shutters with quiet mode

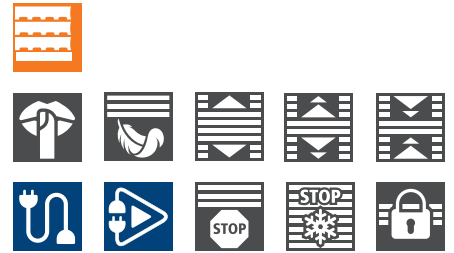

Mechatronic end position detection with soft cut-out, intelligent force measurement, upward/downward blind protection and free travel, automatic release for torque cut-off at end position, min. shaft size $\varnothing = 50$ mm, noiseless soft brake up to 25 Nm. Parallel connection with up to three drives possible.

Only in conjunction with rigid shaft connectors!

elero head – wired

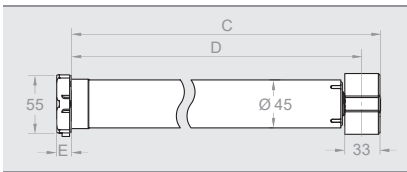

Round head RH – wired

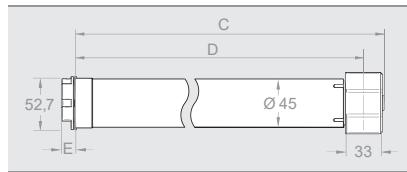

Star head SH – wired

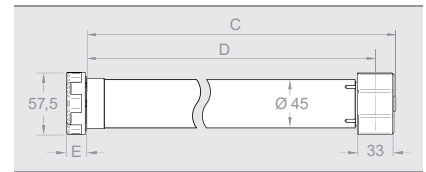

elero head	/D+ M6	/D+ M10	/D+ M20	/D+ M25
Item number	44 013.0001	44 023.0001	44 033.0001	44 043.0001

Round head	/D+ M6 RH	/D+ M10 RH	/D+ M20 RH	/D+ M25 RH
Item number	48 013.0001	48 023.0001	48 033.0001	48 043.0001

Star head	/D+ M6 SH	/D+ M10 SH	/D+ M20 SH	/D+ M25 SH
Item number	49 013.0001	49 023.0001	49 033.0001	49 043.0001

Technical data

Rated torque (Nm)	6	10	20	25
Rated speed (Upm)	14/5	14/5	14/5	14/5
Rated voltage (V)	1 ~ 230	1 ~ 230	1 ~ 230	1 ~ 230
Rated frequency (Hz)	50	50	50	50
Noiseless soft brake	•	•	•	•
Rated current (A)	0.4	0.5	0.8	1.1
Rated power consumption (W)	92	115	184	253
Operating time (min S2)	10	10	10	10
Length C (mm)	466	466	526	546
Length D (mm)	449	449	509	529
Length E (mm)	elero head = 14, round head = 12, star head = 19			
Weight (kg)	1.7	1.7	2.1	2.5

Accessories, such as connection and assembly cables, adapter sets and motor bearings, can be found in the section “RevoLine M accessories” on page 72. Suitable control systems can be found in the section “Wall-mounted devices” on page 214.

RoTop M-868 / RoTop M



With a diameter of 45 mm and a minimum length of 403 mm (K version), the tubular drives of the RoTop M series are suitable for space-saving roller shutters, blinds and screens.

The majority of drives are available with or without an integrated radio system. Drives from 2.5 to 50 Nm are available with 14 to 90 rpm, depending on the version. Drives with soft brakes (up to max. 20 Nm) are suitable for low-noise movement of the blind. All drives are easy

to install and adjust in a time-saving manner. With the RH and SH tubular drives, the range of applications of the M series has been further expanded. The main feature of the RH drives is the wrap-around round head, which reduces the space required on the side significantly. Drives of the SH series (star head motor bearing) fit, among others, in motor bearings of various competitors. The NHK drives also offer an emergency operation option with an emergency crank handle.

RoTop M drives are available with different drive heads:

elero head

- Small deduction dimension
- Suitable for all RevoLine motor bearings from elero

Radio control



Wired



RH head (round head)

- Tubular drive with wrap-around round motor head
- Very small deduction dimension
- Individually deployable



SH head (star head)

- Tubular drive with star motor head
- Suitable for common star motor bearings



NHK head (emergency manual operation)

- NHK operation with 7 mm, hexagonal and 6 mm, square crank



Bidirectional routing with ProLine 2



ProLine 2, the bidirectional radio system from elero, is more reliable, powerful and transparent than unidirectional radio standards.

At the heart of the technology (868 MHz) are bidirectional radio components

(transceivers) that are capable not only of receiving, but also of confirming and relaying the signals. As soon as a command has been executed on the drive, the user receives feedback and can be sure that the commands are being executed correctly.



Applications	RoTop M-868 /-K RoTop M /-K	RoTop M-868 RoTop M high-speed version	RoTop/D+ M-868 RoTop/D+ M	RoTop/D+ M NHK	RoTop s_onro M-868 RoTop s_onro M	RoTop/J M-868 RoTop/J M
Page	52/54	52/54	56	57	58	59
Roller shutters	•	•	•	•		
Roller blinds and screens	•	•				
s_onro roller shutter					•	
Tiltable roller shutters						•

TOP functions	RoTop M-868 /-K RoTop M /-K	RoTop M-868 RoTop M high-speed version	RoTop/D+ M-868 RoTop/D+ M	RoTop/D+ M NHK	RoTop s_onro M-868 RoTop s_onro M	RoTop/J M-868 RoTop/J M
Special features	End positions freely adjustable - K = short design	High-speed version	Plug & play / self-learning end positions	Emergency manual operation	Soft cut-out in downward direction	Roller shutter with venetian blind function
Mechatronic limit position detection with soft cut-out	•	•	•	•	•	•
Intelligent force measurement	•	•	•	•	•	•
Upward/downward blind protection and free travel	•+	•+	•	•	•	•
Self-learning end positions with release function			•	•		
Release can be activated at end positions	•	•			•	
End positions can be set with assembly cable and/or hand-held transmitter	•	•			•	•
Parallel connection possible (wired version only)	•	•	•	•	•	•
Only in conjunction with rigid shaft connectors			•	•		

* Without free travel +without free travel depending on version

Technical data	RoTop M-868 /-K RoTop M /-K	RoTop M-868 RoTop M high-speed version	RoTop/D+ M-868 RoTop/D+ M	RoTop/D+ M NHK	RoTop s_onro M-868 RoTop s_onro M	RoTop/J M-868 RoTop/J M
Rated torque (Nm)	6 to 50	1.8 to 12	6 to 30	6 to 30	10 to 50	10 to 50
Rated speed (Upm)	14	23 to 90	14	14	14	14
Min. shaft diameter (mm)	50	50	50	50	50	50
Diameter (mm)	45	45	45	45	45	45
Length (mm)	from 405 (K version)	from 478	from 460	from 550	from 480	from 480
Noiseless soft brake (up to 20 Nm)	•	• (not M9/35/-868)	•	•	•	•
Protection class (IP)	44	44	44	44	44	44
Limit switch range (rev.)	40	40	40	40	40	40
Ambient operating temperature (°C)	-20 to +60	-20 to +60	-20 to +60	-20 to +60	-20 to +60	-20 to +60
Conformity						
Plug-in connection cable, 2.0 m	•	•	•	•	•	•

End position programming		RoTop M-868 /-K RoTop M /-K	RoTop M-868 RoTop M high-speed version	RoTop/D+ M-868 RoTop/D+ M	RoTop/D+ M NHK	RoTop s_onro M-868 RoTop s_onro M	RoTop/J M-868 RoTop/J M
Top	Bottom						
To stop	Freely adjustable	•	•			•	•
Freely adjustable	To stop	•	•			•	•
To stop	To stop	•	•	• ¹	• ¹	•	•
Freely adjustable	Freely adjustable	•	•			•	•

¹ Self-learning end positions

RolTop M-868 /-K

Radio tubular drives for roller shutters, blinds, insect protection and screens



Mechatronic end position detection with soft cut-out, intelligent force measurement, upward/downward blind protection and free travel, activatable release at end position, end positions adjustable by radio or with assembly cable, min. shaft size $\varnothing = 50$ mm, noiseless soft brake up to 20 Nm, bidirectional radio control at 868 MHz with automatic routing function and feedback.

works with
Yubii Home

elero head – radio control

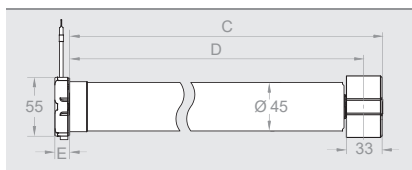

Round head RH – radio control

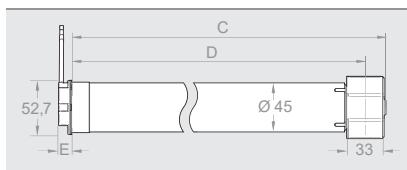

Star head SH – radio control

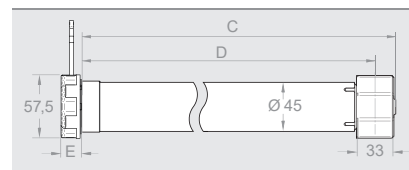

elero head			M2,5/90 -868		M6 -868	M6/35 -868	M7/23 -868	M9/35 -868
Item number			34 160.0006		34 302.0006	34 238.0006	34 226.0006	34 248.0006
Round head		M1,8/138 -868 RH	M2,5/90 -868 RH	M4/60 -868 RH		M6/35 -868 RH	M7/23 -868 RH	M9/35 -868 RH
Item number		38 450.0006	38 160.0006	38 460.0006		38 438.0006	38 226.0006	38 448.0006
Star head					M6 -868 SH			
Item number					39 302.0006			

Observe the attachment instructions on page 76!

Technical data

Rated torque (Nm)	1.8	2,5	4	6	6	7	9
Rated speed (Upm)	138	90	60	14	35	23	35
Rated voltage (V)	1 ~ 230	1 ~ 230	1 ~ 230	1 ~ 230	1 ~ 230	230 ~ 240	1 ~ 230
Rated frequency (Hz)	50	50	50	50	50	50	50
Noiseless soft brake	•	•	•	•	•	•	–
High-speed version	•	•	•	–	•	•	•
Rated current (A)	0.9	0.9	0.9	0.52	0.9	0.6	0.9
Rated power consumption (W)	200	200	200	118	200	140	140
Operating time (min. S2)	5	5	5	4	5	5	4
Length C (mm)	526	526	526	445	526	466	466
Length D (mm)	509	509	509	428	509	449	449
Length E (mm)	elero head = 14,			round head = 12,		star head = 19	
Weight (kg)	1.9	1.9	1.9	1.6	1.8	1.7	1.7

Accessories, such as connection and assembly cables, adapter sets and motor bearings, can be found in the section “RevolLine M accessories” on page 72. Suitable control units such as radio transmitters and sensors can be found in the section “Home automations” from page 138.

RoTop M-868 /-K

Radio tubular drives for roller shutters, blinds, insect protection and screens

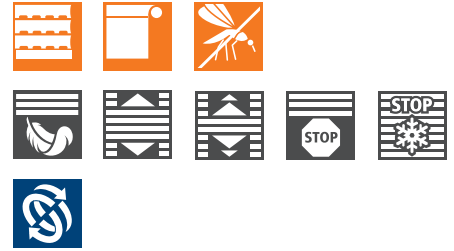

Mechatronic end position detection with soft cut-out, intelligent force measurement, upward/downward blind protection, with and without free travel, activatable release at end position, end positions adjustable by radio control or with assembly cable, min. shaft size Ø = 50 mm, noiseless soft brake up to 20 Nm, bidirectional radio control at 868 MHz with automatic routing function and feedback.

works with
Yubii® Home

elero head – radio control

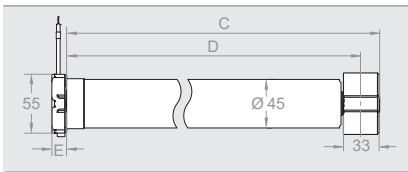

Round head RH – radio control

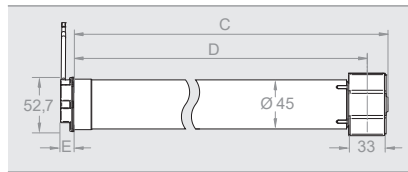

Star head SH – radio control

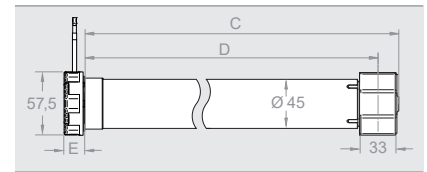

elero head		M10 -868	M10 -868-K	M12/23 -868	M20 -868	M30 -868	M40 -868	M50 -868
Item number		34 222.0006	34 112.0007	34 236.0006	34 232.0006	34 242.0006	34 252.0006	34 262.0006
elero head		Without free travel M10-868			Without free travel M20-868	Without free travel M30-868	Without free travel M40-868	Without free travel M50-868
Item number		34 222.0076			34 232.0076	34 242.00076	34 252.0076	34 262.0076
Round head		M10 -868 RH	M10 -868-K RH	M12/23 -868 RH	M20 -868 RH	M30 -868 RH		
Item number		38 222.0006	38 112.0007	38 236.0006	38 232.0006	38 242.0006	Observe the attachment instructions on page 76!	
Star head		M10 -868 SH	M10 -868-K SH		M20 -868 SH	M30 -868 SH	M40 -868 SH	M50 -868 SH
Item number		39 222.0006	39 112.0007		39 232.0006	39 242.0006	39 252.0006	39 262.0006

Special motors “without free travel” do not reverse if they cut out due to an obstacle. These motors are suitable for lockable roller shutters and small doors.

Technical data

Rated torque (Nm)	10	10	12	20	30	40	50
Rated speed (Upm)	14	14	23	14	14	14	14
Rated voltage (V)	230 – 240	1 ~ 230	1 ~ 230	1 ~ 230	1 ~ 230	1 ~ 230	1 ~ 230
Rated frequency (Hz)	50	50	50	50	50	50	50
Noiseless soft brake	•	•	•	•	–	–	–
High-speed version	–	–	•	–	–	–	–
Rated current (A)	0.6	0.6	0.9	0.9	0.9	1.2	1.3
Rated power consumption (W)	140	140	200	200	200	270	300
Operating time (min. S2)	5	4	5	4	4	5	4
Length C (mm)	466	391	526	526	516	546	546
Length D (mm)	449	374	509	509	499	529	529
Length E (mm)	elero head = 14, round head = 12, star head = 19						
Weight (kg)	1.7	1.5	1.9	2.1	2.3	2.6	3.1

Accessories, such as connection and assembly cables, adapter sets and motor bearings, can be found in the section “RevoLine M accessories” on page 72. Suitable control units such as radio transmitters and sensors can be found in the section “Home automations” from page 138.

RolTop M /-K

Tubular drives for roller shutters, blinds, insect protection and screens



Mechatronic end position detection with soft cut-out, intelligent force measurement, upward/downward blind protection and free travel, activatable release at end position, end positions adjustable with assembly cable, min. shaft size $\varnothing = 50$ mm, noiseless soft brake up to 20 Nm, parallel connection possible.

elero head – wired

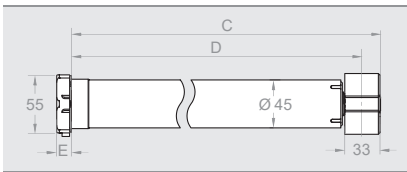

Round head RH – wired

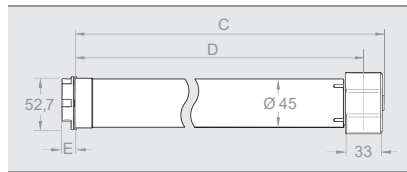

Star head SH – wired

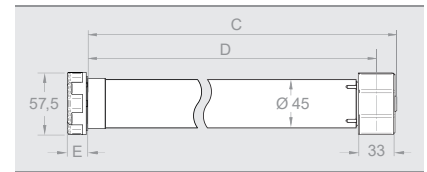

elero head		M2.5/90		M6	M6/35	M7/23	M9/35
Item number		34 169.0001		34 301.0001	34 237.0001	34 225.0001	34 247.0001

Round head	M1.8/138 RH	M2.5/90 RH	M4/60 RH		M7/23 RH	
Item number	38 459.0001	38 169.0001	38 469.0001		38 225.0001	

Star head		M6 SH	
Item number		39 301.0001	

Observe the attachment instructions on page 76!

Technical data

Rated torque (Nm)	1,8	2,5	4	6	6	7	9
Rated speed (Upm)	138	90	60	14	35	23	35
Rated voltage (V)	1 ~ 230	1 ~ 230	1 ~ 230	1 ~ 230	1 ~ 230	230 – 240	1 ~ 230
Rated frequency (Hz)	50	50	50	50	50	50	50
Noiseless soft brake	•	•	•	•	•	•	–
High-speed version	•	•	•	–	•	•	•
Rated current (A)	0.9	0.9	0.9	0.52	0.9	0.6	0.9
Rated power consumption (W)	200	200	200	118	200	140	140
Operating time (min. S2)	5	5	5	4	5	5	4
Length C (mm)	526	526	526	445	526	466	466
Length D (mm)	509	509	509	428	509	449	449
Length E (mm)	elero head = 14,			round head = 12,		star head = 19	
Weight (kg)	1.9	1.9	1.9	1.6	1.8	1.7	1.7

Accessories, such as connection and assembly cables, adapter sets and motor bearings, can be found in the section “RevoLine M accessories” on page 72. Suitable control systems can be found in the section “Wall-mounted devices” on page 214.

RoTop M /-K

Tubular drives for roller shutters, blinds, insect protection and screens



Mechatronic end position detection with soft cut-out, intelligent force measurement, upward/downward blind protection, with and without free travel, activatable release at end position, end positions adjustable with assembly cable, min. shaft size $\varnothing = 50$ mm, noiseless soft brake up to 20 Nm, parallel connection possible.

elero head – wired

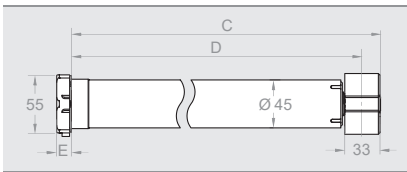

Round head RH – wired

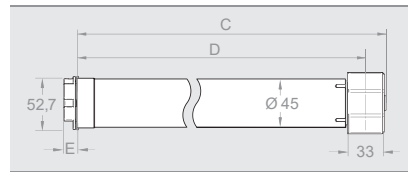

Star head SH – wired

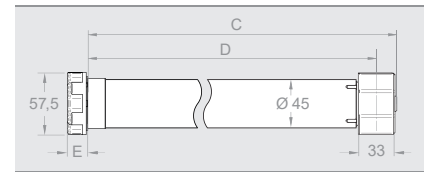

elero head		M10	M10-K	M12/23	M20	M30	M40	M50
Item number		34 221.0001	34 111.0002	34 235.0001	34 231.0001	34 241.0001	34 251.0001	34 261.0001

elero head		Without free travel M10			Without free travel M20	Without free travel M30	Without free travel M40	Without free travel M50
Item number		34 221.0007			34 231.0007	34 241.0007	34 251.0007	34 261.0007

Special motors “without free travel” do not reverse if they cut out due to an obstacle. These motors are suitable for lockable roller shutters and small doors.

Round head		M10 RH	M10-K RH	M12/23 RH	M20 RH	M30 RH	Observe the attachment instructions on page 76!	
Item number		38 221.0001	38 111.0002	38 235.0001	38 231.0001	38 241.0001		

Star head		M10 SH	M10-K SH		M20 SH	M30 SH	M40 SH	M50 SH
Item number		39 221.0001	39 111.0002		39 231.0001	39 241.0001	39 251.0001	39 261.0001

Technical data

Rated torque (Nm)	10	10	12	20	30	40	50
Rated speed (Upm)	14	14	23	14	14	14	14
Rated voltage (V)	230 – 240	1 ~ 230	1 ~ 230	1 ~ 230	1 ~ 230	1 ~ 230	1 ~ 230
Rated frequency (Hz)	50	50	50	50	50	50	50
Noiseless soft brake	•	•	•	•	–	–	–
High-speed version	–	–	•	–	–	–	–
Rated current (A)	0.6	0.6	0.9	0.9	0.9	1.2	1.3
Rated power consumption (W)	140	140	200	200	200	270	300
Operating time (min. S2)	5	4	5	4	4	5	4
Length C (mm)	466	391	526	526	516	546	546
Length D (mm)	449	374	509	509	499	529	529
Length E (mm)	elero head = 14, round head = 12, star head = 19						
Weight (kg)	1.7	1.5	1.9	2.1	2.3	2.6	3.1

Accessories, such as connection and assembly cables, adapter sets and motor bearings, can be found in the section “RevoLine M accessories” on page 72. Suitable control systems can be found in the section “Wall-mounted devices” on page 214.

RoTop/D+ M-868 RoTop/D+ M

Tubular drives for roller shutters

Mechatronic end position detection with soft cut-out, intelligent force measurement, upward/downward blind protection and free travel, self-learning end positions with automatic release function, min. shaft size $\varnothing = 50$ mm, noiseless soft brake up to 20 Nm, bidirectional radio control at 868 MHz with automatic routing function and feedback (with radio drives). Parallel connection possible (with wired drives).



works with
Yubii® Home¹

elero head

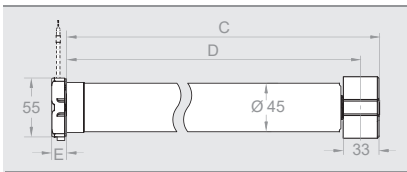

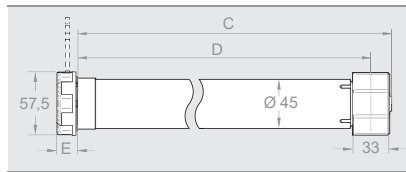

Star head SH



Only in conjunction with rigid shaft connectors!

elero head 	/D+ M6 -868	/D+ M10 -868	/D+ M20 -868	/D+ M30 -868
Item number	34 014.0006	34 024.0006	34 034.0006	34 044.0006

Star head 	/D+ M6 -868 SH	/D+ M10 -868 SH	/D+ M20 -868 SH	/D+ M30 -868 SH
Item number	39 014.0006	39 024.0006	39 034.0006	39 044.0006

elero head 	/D+ M6	/D+ M10	/D+ M20	/D+ M30
Item number	34 013.0001	34 023.0001	34 033.0001	34 043.0001

Star head 	/D+ M6 SH	/D+ M10 SH	/D+ M20 SH	/D+ M30 SH
Item number	39 013.0001	39 023.0001	39 033.0001	39 043.0001

Technical data				
Rated torque (Nm)	6	10	20	30
Rated speed (Upm)	14	14	14	14
Rated voltage (V)	1 ~ 230	230 – 240	1 ~ 230	1 ~ 230
Rated frequency (Hz)	50	50	50	50
Noiseless soft brake	•	•	•	–
Rated current (A)	0.52	0.6	0.9	0.9
Rated power consumption (W)	118	140	200	200
Operating time (min. S2)	4	5	4	4
Length C (mm)	446	466	526	516
Length D (mm)	429	449	509	499
Length E (mm)	elero head = 14			
Weight (kg)	1.4	1.8	2.2	2.3

Technical data				
Rated torque (Nm)	6	10	20	30
Rated speed (Upm)	14	14	14	14
Rated voltage (V)	1 ~ 230	230 – 240	1 ~ 230	1 ~ 230
Rated frequency (Hz)	50	50	50	50
Noiseless soft brake	•	•	•	–
Rated current (A)	0.52	0.6	0.9	0.9
Rated power consumption (W)	118	140	200	200
Operating time (min. S2)	4	5	4	4
Length C (mm)	446	466	526	516
Length D (mm)	429	449	509	499
Length E (mm)	Star head = 19			
Weight (kg)	1.4	1.8	2.2	2.3

Accessories, such as connection and assembly cables, adapter sets and motor bearings, can be found in the section "RevoLine M accessories" on page 72. Suitable control systems and radio transmitters and sensors can be found in the section "Home automations" from page 138 and in the section "Wall-mounted-devices" on page 214.

¹ only 868-variants

RoITop/D+ M NHK

Tubular drives with emergency crank handle

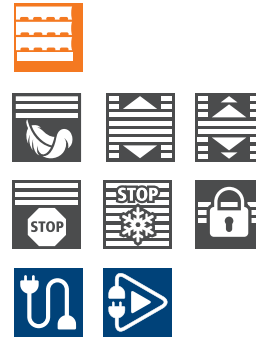

Mechatronic end position detection with soft cut-out, intelligent force measurement, upward/downward blind protection and free travel, self-learning end positions with release function, min. shaft size $\varnothing = 50$ mm, noiseless soft brake up to 20 Nm, NHK operation with 7 mm, hexagonal and 6 mm, square crank.

NHK head

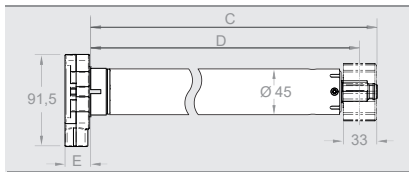

Only in conjunction with rigid shaft connectors!

NHK head	/D+ M6 NHK	/D+ M10 NHK	/D+ M20 NHK	/D+ M30 NHK
Item number	34 103.0001	34 113.0001	34 123.0001	34 133.0001

Technical data

Rated torque (Nm)	6	10	20	30
Rated speed (Upm)	14	14	14	14
Rated voltage (V)	1 ~ 230	230 – 240	1 ~ 230	1 ~ 230
Rated frequency (Hz)	50	50	50	50
Noiseless soft brake	•	•	•	–
Rated current (A)	0.52	0.6	0.9	0.9
Rated power consumption (W)	118	140	200	200
Operating time (min. S2)	4	5	4	4
Length C (mm)	524	544	604	594
Length D (mm)	507	527	587	577
Length E (mm)	26	26	26	26
Weight (kg)	2.0	2.4	2.9	3.1
NHK transmission ratio	18:1	18:1	18:1	30:1

Compatible accessories	Assembly kit (including 16 x 16 mm motor bolts)
Item number	23 162.0801

Accessories such as connection and assembly cables, adapter sets and motor bearings can be found in the section “RevoLine M NHK accessories” on page 79.

Suitable control systems and transmitters and sensors can be found in the section “Control systems” on page 214.

RolTop M-868 s_onro

RolTop M s_onro

Tubular drives with particularly gentle downward cut-out

Mechatronic end position detection with soft cut-out, intelligent force measurement, upward/downward blind protection and free travel, activatable release at end position, end positions adjustable by radio or with assembly cable, min. shaft size $\varnothing = 50$ mm, noiseless soft brake up to 20 Nm, bidirectional radio control at 868 MHz with automatic routing function and feedback (with radio drives). For s_onro roller shutters.



works with
Yubii® Home¹

elero head – radio control

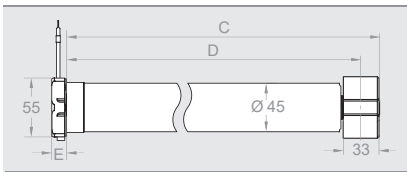

elero head – wired

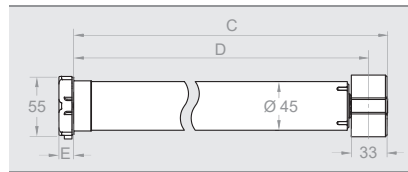

elero head 	M10-868 s_onro	M20-868 s_onro	M30-868 s_onro
Item number	34 222.5606	34 232.5606	34 242.5606

elero head 	M10 s_onro	M20 s_onro	M30 s_onro
Item number	34 221.5601	34 231.5601	34 241.5601

SH head 	M10 s_onro SH	M20 s_onro SH	M30 s_onro SH	M40 s_onro SH	M50 s_onro SH
Item number	39 221.5601	39 231.5601	39 241.5601	39 251.5601	39 261.5601

Technical data

Rated torque (Nm)	10	20	30	40	50
Rated speed (Upm)	14	14	14	14	14
Rated voltage (V)	230 – 240	1 ~ 230	1 ~ 230	1 ~ 230	1 ~ 230
Rated frequency (Hz)	50	50	50	50	50
Noiseless soft brake	•	•	–	–	–
Rated current (A)	0.6	0.9	0.9	1.2	1.3
Rated power consumption (W)	140	200	200	270	300
Operating time (min. S2)	5	4	4	5	4
Length C (mm)	446	526	516	546	546
Length D (mm)	449	509	499	529	529
Length E (mm)	elero head = 14 Star head = 19				
Weight (kg)	1.9	2.2	2.3	2.6	3.1

Accessories, such as connection and assembly cables, adapter sets and motor bearings, can be found in the section “RevoLine M accessories” on page 72.

Suitable control systems as well as transmitters and sensors can be found in the section “Control systems” on page 214.

¹ only 868-variants

RolTop/J M-868

RolTop/J M

Tubular drives for roller shutters with venetian blind function

Mechatronic end position detection with soft cut-out, intelligent force measurement, upward/downward blind protection and free travel, activatable release at end position, end positions adjustable by radio control or with assembly cable, min. shaft size $\varnothing = 50$ mm, noiseless soft brake up to 20 Nm, adapted to various systems, special function with third position (venetian blind position). Bidirectional radio control at 868 MHz with automatic routing function and feedback (with radio drives).



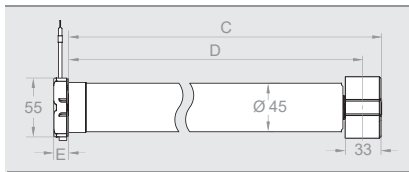

works with
Yubii® Home¹

elero head – radio control

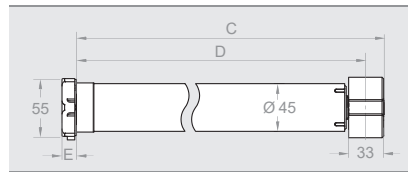

elero head – wired



elero head 	/J M10-868	/J M20-868	/J M30-868	/J M40-868	/J M50-868
Item number	34 224.0006	34 234.0006	34 244.0006	34 254.0006	34 264.0006

elero head 	/J M10	/J M20	/J M30	/J M40	/J M50
Item number	34 223.0001	34 233.0001	34 243.0001	34 253.0001	34 263.0001

Technical data

Rated torque (Nm)	10	20	30	40	50
Rated speed (Upm)	14	14	14	14	14
Rated voltage (V)	230 – 240	1 ~ 230	1 ~ 230	1 ~ 230	1 ~ 230
Rated frequency (Hz)	50	50	50	50	50
Noiseless soft brake	•	•	–	–	–
Rated current (A)	0.6	0.9	0.9	1.2	1.3
Rated power consumption (W)	140	200	200	270	300
Operating time (min. S2)	5	4	4	5	4
Length C (mm)	466	526	516	546	546
Length D (mm)	449	509	499	529	529
Length E (mm)	elero head = 14				
Weight (kg)	1.8	1.9	2.2	2.6	3.1

Accessories, such as connection and assembly cables, adapter sets and motor bearings, can be found in the section “RevoLine M accessories” on page 72.

Suitable control systems as well as radio transmitters and sensors can be found in the section “Control systems” on page 214.

¹ only 868-variants

SunTop M-868 / SunTop M



The SunTop M-868 and SunTop M tubular drives of the M series are especially suitable for awnings, roller blinds and screens. With a diameter of 45 mm and a minimum length of 478 mm, the medium-sized drive of the SunTop series is especially designed for space-saving systems. The drives are available with and without an integrated radio system. Drives from 2.5 to 50 Nm are available with 14 to 90 rpm, depending on the version. Where noise is particularly disturbing, the use of drives

(up to max. 20 Nm) with noiseless soft brakes is recommended. All drives can be easily installed and adjusted in a time-saving manner. With the RH and SH tubular drives, the range of applications of the M series has been further expanded. The main feature of the RH drives is the wrap-around round head, which significantly reduces the space required on the side. Drives of the SH series fit, among others, in numerous motor bearings of various competitors.

SunTop M drives are available with three different drive heads:

elero head

- Small deduction dimension
- Suitable for all RevoLine motor bearings from elero

Radio control



Wired



RH head (round head)

- Tubular drive with wrap-around round motor head
- Very small deduction dimension
- Individually deployable



SH head (star head)

- Tubular drive with star motor head
- Suitable for common star motor bearings



Bidirectional routing with ProLine 2



ProLine 2, the bidirectional radio system from elero, is more reliable, powerful and transparent than unidirectional radio standards. At the heart of the technology (868 MHz) are bidirectional radio components

(transceivers) that are capable not only of receiving, but also of confirming and relaying the signals. As soon as a command has been executed on the drive, the user receives feedback and can be sure that the commands are being executed correctly.



Applications	SunTop M-868 SunTop M	SunTop M-868 SunTop M High-speed version	SunTop/Z M-868 SunTop/Z M	SunTop/Z M-868 SunTop/Z M High-speed version
Page	62/63	62/63	64/65	64/65
Textile sun protection	•	•	•	•

TOP functions	SunTop M-868 SunTop M	SunTop M-868 SunTop M High-speed version	SunTop/Z M-868 SunTop/Z M	SunTop/Z M-868 SunTop/Z M High-speed version
Special features	End positions freely adjustable	High-speed version	Blocking detection (upward direction) and blind protection (downward direction) with repeat function	Blocking detection (upward direction) and blind protection (downward direction) with repeat function
Mechatronic end position detection with soft cut-out	•	•	•	•
Intelligent force measurement	•	•	•	•
Upward/downward blocking detection	•	•		
Upward blocking detection with repeat function			•	•
Downward blind protection with repeat function			•	•
Release can be activated at end positions	•	•	•	•
End positions can be set with assembly cable and/or hand-held transmitter	•	•	•	•
Parallel connection possible (wired version only)	•	•	•	•

Technical data	SunTop M-868 SunTop M	SunTop M-868 SunTop M High-speed version	SunTop/Z M-868 SunTop/Z M	SunTop/Z M-868 SunTop/Z M High-speed version
Rated torque (Nm)	10 to 50	7 to 12	10 to 30	2.5 to 28
Rated speed (rpm)	14	23	14	23 to 90
Min. shaft diameter (mm)	50	50	50	50
Diameter (mm)	45	45	45	45
Length (mm)	from 478	from 478	from 478	from 478
Noiseless soft brake (up to 20 Nm)	•	•	• <i>(not SunTop/Z M 18/23-868)</i>	• <i>(not SunTop/Z M18/23)</i>
Protection class (IP)	44	44	44	44
Limit switch range (rev.)	40	40	40	40
Ambient operating temperature (°C)	-20 to +60	-20 to +60	-20 to +60	-20 to +60
Conformity				
Plug-in connection cable, 2.0 m	•	•	•	•

End position programming		SunTop M-868 SunTop M	SunTop M-868 SunTop M High-speed version	SunTop/Z M-868 SunTop/Z M	SunTop/Z M-868 SunTop/Z M High-speed version
Top	Bottom				
To stop	Freely adjustable	•	•	•	•
Freely adjustable	To stop	•	•	•	•
To stop	To stop	•	•	•	•
Freely adjustable	Freely adjustable	•	•	•	•

SunTop M-868

Radio tubular drives
for textile sun protection



Mechatronic end position detection with soft cut-out, intelligent force measurement, upward/downward blocking detection, activatable release at end position, end positions adjustable by radio transmission or with assembly cable, min. shaft size $\varnothing = 50$ mm, noiseless soft brake up to 20 Nm, bidirectional radio (868 MHz) with automatic routing function and feedback.

works with
Yubii® Home

elero head – radio control

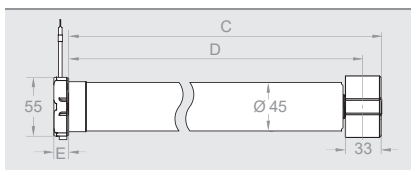

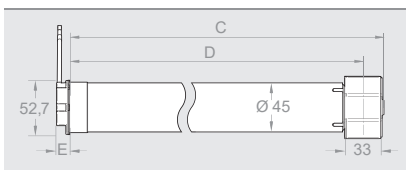

Round head RH – radio control

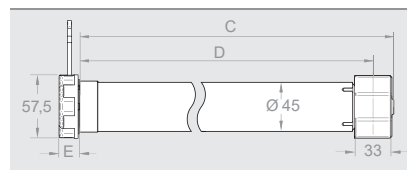

Star head SH – radio control



elero head 	M7/23 -868	M10 -868	M12/23 -868	M20 -868	M30 -868	M40 -868	M50 -868
Item number	34 726.0006	34 722.0006	34 736.0006	34 732.0006	34 742.0006	34 752.0006	34 762.0006
Round head 		M10 -868 RH		M20 -868 RH	M30 -868 RH	M40 -868 RH	M50 -868 RH
Item number		38 722.0006		38 732.0006	38 742.0006	38 752.0006	38 762.0006
Star head 		M10-868 SH		M20 -868 SH	M30 -868 SH	M40 -868 SH	M50 -868 SH
Item number		39 722.0006		39 732.0006	39 742.0006	39 752.0006	39 762.0006

Technical data

Rated torque (Nm)	7	10	12	20	30	40	50
Rated speed (rpm)	23	14	23	14	14	14	14
Rated voltage (V)	230 – 240	230 – 240	1 ~ 230	1 ~ 230	1 ~ 230	1 ~ 230	1 ~ 230
Rated frequency (Hz)	50	50	50	50	50	50	50
Noiseless soft brake	•	•	•	•	–	–	–
High-speed version	•	–	•	–	–	–	–
Rated current (A)	0.6	0.6	0.9	0.9	0.9	1.2	1.3
Rated power consumption (W)	140	140	200	200	200	270	300
Operating time (min. S2)	5	5	5	4	4	5	4
Length C (mm)	466	466	526	526	516	546	546
Length D (mm)	449	449	509	509	499	529	529
Length E (mm)	elero head = 14, round head = 12, star head = 19						
Weight (kg)	1.7	1.7	2.1	2.2	2.3	2.5	3.1

Accessories, such as connection and assembly cables, adapter sets and motor bearings, can be found in the section “RevoLine M accessories” on page 72.

Suitable control systems and radio transmitters and sensors can be found in the section “Home automations” on page 138.

SunTop M

Tubular drives for textile sun protection



Mechatronic end position detection with soft cut-out, intelligent force measurement, upward/downward blocking detection, activatable release at end position, end positions adjustable with assembly cable, min. shaft size $\varnothing = 50$ mm, parallel connection possible, noiseless soft brake up to 20 Nm.

elero head – wired

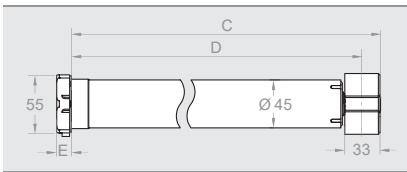

Round head RH – wired

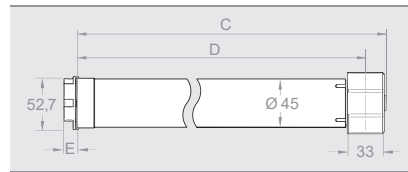

Star head SH – wired

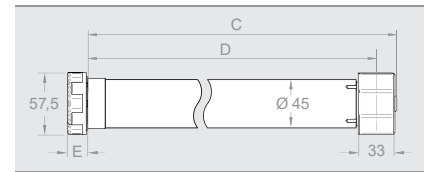

elero head	M7/23	M10	M12/23	M20	M30	M40	M50
Item number	34 725.0001	34 721.0001	34 735.0001	34 731.0001	34 741.0001	34 751.0001	34 761.0001

Round head	M7/23 RH	M10 RH	M12/23 RH	M20 RH	M30 RH	M40 RH	M50 RH
Item number	38 725.0001	38 721.0001	38 735.0001	38 731.0001	38 741.0001	38 751.0001	38 761.0001

Star head	M10 SH	M20 SH	M30 SH	M40 SH	M50 SH
Item number	39 721.0001	39 731.0001	39 741.0001	39 751.0001	39 761.0001

Technical data

	7	10	12	20	30	40	50
Rated torque (Nm)	7	10	12	20	30	40	50
Rated speed (rpm)	23	14	23	14	14	14	14
Rated voltage (V)	230 – 240	230 – 240	1 ~ 230	1 ~ 230	1 ~ 230	1 ~ 230	1 ~ 230
Rated frequency (Hz)	50	50	50	50	50	50	50
Noiseless soft brake	•	•	•	•	–	–	–
High-speed version	•	–	•	–	–	–	–
Rated current (A)	0.6	0.6	0.9	0.9	0.9	1.2	1.3
Rated power consumption (W)	140	140	200	200	200	270	300
Operating time (min. S2)	5	5	5	4	4	5	4
Length C (mm)	466	466	526	526	516	546	546
Length D (mm)	449	449	509	509	499	529	529
Length E (mm)	elero head = 14, round head = 12, star head = 19						
Weight (kg)	1.7	1.7	2.1	2.2	2.3	2.5	3.1

Accessories, such as connection and assembly cables, adapter sets and motor bearings, can be found in the section “RevoLine M accessories” on page 72. Suitable control systems can be found in the section “Wall-mounted devices” on page 214.

SunTop/Z M-868

Radio tubular drives for ZIP systems

Mechatronic end position detection with soft cut-out, intelligent force measurement, upward blocking detection with repeat function, downward blind protection with repeat function, release activatable at end position, end positions adjustable by radio control or with assembly cable, min. shaft size $\varnothing = 50$ mm, noiseless soft brake up to 20 Nm (except SunTop/Z M 18/23-868), bidirectional radio control (868 MHz) with automatic routing function and feedback.



works with
Yubii® Home

Round head RH – radio control

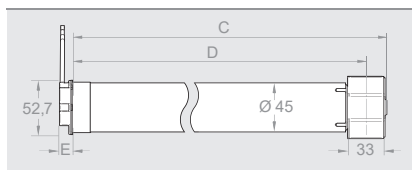

Star head SH – radio control

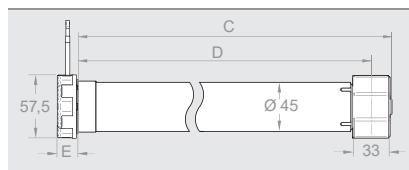

Round head	/Z M2,5/90 -868 RH	/Z M4/60 -868 RH	/Z M7/23 -868 RH	/Z M10 -868 RH	/Z M12/23 -868 RH	/Z M18/23 -868 RH	/Z M20 -868 RH	/Z M28/23 -868 RH	/Z M30 -868 RH
Item number	38 660.0006	38 670.0006	38 624.0006	38 632.0006	38 634.0006	38 684.0006	38 642.0006	38 694.0006	38 652.0006
Star head			/Z M7/23 -868 SH	/Z M10 -868 SH	/Z M12/23 -868 SH	/Z M18/23 -868 SH	/Z M20 -868 SH	/Z M28/23 -868 SH	/Z M30 -868 SH
Item number			39 624.0006	39 632.0006	39 634.0016	39 684.0006	39 642.0006	39 694.0006	39 652.0006

Technical data

Rated torque (Nm)	2.5	4	7	10	12	18	20	28	30
Rated speed (rpm)	90	60	23	14	23	23	14	23	14
Rated voltage (V)	1 ~ 230	1 ~ 230	230 – 240	230 – 240	1 ~ 230	1 ~ 230	1 ~ 230	1 ~ 230	1 ~ 230
Rated frequency (Hz)	50	50	50	50	50	50	50	50	50
Noiseless soft brake	•	•	•	•	•	–	•	–	–
High-speed version	•	•	•	–	•	•	–	•	–
Rated current (A)	0.9	0.9	0.6	0.6	0.9	0.9	0.9	1.25	0.9
Rated power consumption (W)	200	200	140	140	200	200	200	285	200
Operating time (min. S2)	5	5	5	5	5	5	4	4	4
Length C (mm)	527	526	466	466	516	516	527	545	516
Length D (mm)	510	509	449	449	499	499	510	528	499
Length E (mm)	round head = 12, star head = 19								
Weight (kg)	1.8	2.0	1.8	1.8	2.2	2.2	2.2	2.6	2.2

Accessories, such as connection and assembly cables, adapter sets and motor bearings, can be found in the section “RevoLine M accessories” on page 72.

Suitable control systems and radio transmitters and sensors can be found in the section “Home automations” on page 138.

SunTop/Z M

Tubular drives for ZIP systems



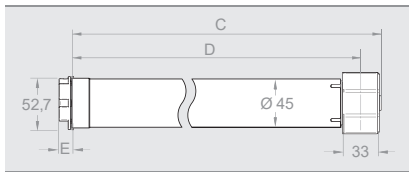

Mechatronic end position detection with soft cut-out, intelligent force measurement, upward blocking detection with repeat function, downward blind protection with repeat function, activatable release at end position, end positions adjustable with assembly cable, min. shaft size $\varnothing = 50$ mm, parallel connection possible, noiseless soft brake up to 20 Nm (except SunTop/Z M 18/23).

Round head RH – wired

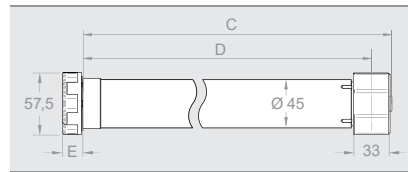

Star head SH – wired



Round head		/Z M2,5/90 RH	/Z M4/60 RH	/Z M7/23 RH	/Z M10 RH	/Z M12/23 RH	/Z M18/23 RH	/Z M20 RH	/Z M28/23 RH	/Z M30 RH
Item number		38 669.0001	38 679.0001	38 623.0001	38 631.0001	38 633.0001	38 683.0001	38 641.0001	38 693.0001	38 651.0001
Star head				/Z M7/23 SH	/Z M10 SH		/Z M18/23 SH	/Z M20 SH	/Z M28/23 SH	/Z M30 SH
Item number				39 623.0001	39 631.0001		39 683.0001	39 641.0001	39 693.0001	39 651.0001

Technical data

Rated torque (Nm)	2.5	4	7	10	12	18	20	28	30
Rated speed (rpm)	90	60	23	14	23	23	14	23	14
Rated voltage (V)	1 ~ 230	1 ~ 230	230 – 240	230 – 240	1 ~ 230	1 ~ 230	1 ~ 230	1 ~ 230	1 ~ 230
Rated frequency (Hz)	50	50	50	50	50	50	50	50	50
Noiseless soft brake	•	•	•	•	•	–	•	–	–
High-speed version	•	•	•	–	•	•	–	•	–
Rated current (A)	0.9	0.9	0.6	0.6	0.9	0.9	0.9	1.25	0.9
Rated power consumption (W)	200	200	140	140	200	200	200	285	200
Operating time (min. S2)	5	5	5	5	5	5	4	4	4
Length C (mm)	527	526	466	466	516	516	527	545	516
Length D (mm)	510	509	449	449	499	499	510	528	499
Length E (mm)	round head = 12, star head = 19								
Weight (kg)	1.9	1.9	1.9	1.9	2.2	2.2	2.2	2.6	2.2

Accessories, such as connection and assembly cables, adapter sets and motor bearings, can be found in the section “RevoLine M accessories” on page 72. Suitable control systems can be found in the section “Wall-mounted devices” on page 214.

VariEco M-868 / VariEco M / NHK



VariEco M-868 / VariEco M tubular drives are suitable for roller shutters and textile sun protection (from 50 mm). As a drive of the M series in radio and non-radio versions with a diameter of 45 mm and a minimum length of 491 mm, it is ideally suited for space-saving systems. Configurations of 6 to 50 Nm and, depending on the version, 10 to 35 rpm are available. Up to a rated torque of max. 20 Nm, many of these drives are equip-

ped with a noiseless soft brake. All drives can be easily installed and adjusted in a time-saving manner. With the VariEco + /-868 drives, quick end position adjustment is also possible during the initial commissioning. The VariEco M NHK drive is suitable for doors, roller shutters and textile sun protection and has emergency manual operation with a 7 mm hexagonal and 6 mm square shaft.

VariEco M drives are available with the following drive heads:

elero head

- Small deduction dimension
- Suitable for all RevoLine motor bearings from elero

Radio control

Wired



NHK head (emergency crank handle)

- NHK operation with 7 mm hexagonal and 6 mm square crank



Bidirectional routing with ProLine 2



ProLine 2, the bidirectional radio system from elero, is more reliable, powerful and transparent than unidirectional radio standards.

At the heart of the technology (868 MHz) are bidirectional radio components

(transceivers) that are capable not only of receiving, but also of confirming and relaying the signals. As soon as a command has been executed on the drive, the user receives feedback and can be sure that the commands are being executed correctly.



Applications	VariEco M-868 VariEco M	VariEco M-868 VariEco M high-speed version	VariEco+ M-868 VariEco+ M	VariEco+ M-868 VariEco+ M high-speed version	VariEco M NHK
Page	68/69	68/69	68/69	68/69	70
Roller shutters	•	•	•	•	•
Textile sun protection	•	•	•	•	•
Doors					•

TOP functions	VariEco M-868 VariEco M	VariEco M-868 VariEco M high-speed version	VariEco+ M-868 VariEco+ M	VariEco+ M-868 VariEco+ M high-speed version	VariEco M NHK
Special features	End positions freely adjustable	High-speed version	Quick end position adjustment during initial commissioning	Quick end position adjustment during initial commissioning, High-speed version	Emergency manual operation
Mechanical limit switch	•	•	•	•	•
Quick end position adjustment during initial commissioning			•	•	
Emergency manual operation with 7 mm hexagonal and 6 mm square shaft					•

Technical data	VariEco M-868 VariEco M	VariEco M-868 VariEco M high-speed version	VariEco+ M-868 VariEco+ M	VariEco+ M-868 VariEco+ M high-speed version	VariEco M NHK
Rated torque (Nm)	10 to 50	6 to 12	6 to 50	6 to 12	20 to 50
Rated speed (rpm)	10 to 14	23 to 35	10 to 14	23 to 35	14
Min. shaft diameter (mm)	50	50	50	50	50
Diameter (mm)	45	45	45	45	45
Length (mm)	from 491	from 491	from 491	from 491	from 677
Noiseless soft brake (up to 20 Nm)	•	•	•	• <i>(not VariEco M9/35/-868)</i>	•
Protection class (IP)	44	44	44	44	44
Limit switch range (rev.)	35	35	35	35	40
Ambient operating temperature (°C)	-20 to +60	-20 to +60	-20 to +60	-20 to +60	-20 to +60
Conformity					
Plug-in connection cable, 2.0 m	•	•	•	•	•

End position programming		VariEco M-868 VariEco M	VariEco M-868 VariEco M high-speed version	VariEco+ M-868 VariEco+ M	VariEco+ M-868 VariEco+ M high-speed version	VariEco M NHK
Top	Bottom					
Freely adjustable*	Freely adjustable*	•	•	•	•	•

* Mechanical

VariEco M-868 / VariEco+ M-868

Radio tubular drives for roller shutters
and textile sun protection



works with
Yubii® Home

Mechanical limit switches, VariEco+ with quick adjustment, min. shaft size $\varnothing = 50$ mm, noiseless soft brake up to 20 Nm, bidirectional radio control (868 MHz) with automatic routing function and feedback.

elero head – radio control

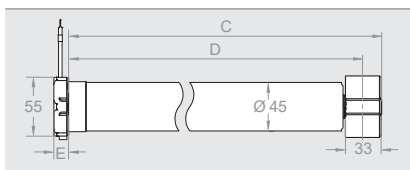

elero head	M6/35 -868	M7/23 -868	M9/35 -868	M10 -868	M12/23 -868	M20 -868	M30 -868	M40 -868	M50 -868
Item number	34 938.0106	34 926.0106	34 948.0106	34 922.0106	34 936.0106	34 932.0106	34 942.0106	34 952.0106	34 962.0106

elero head	+ M6/35 -868	+ M7/23 -868	+ M9/35 -868	+ M12/23 -868
Item number	34 938.0006	34 926.0006	34 948.0006	34 936.0006

Technical data									
Rated torque (Nm)	6	7	9	10	12	20	30	40	50
Rated speed (Upm)	35	23	35	14	23	14	14	14	14
Rated voltage (V)	1 ~ 230	1 ~ 230	1 ~ 230	1 ~ 230	1 ~ 230	1 ~ 230	1 ~ 230	1 ~ 230	1 ~ 230
Rated frequency (Hz)	50	50	50	50	50	50	50	50	50
Noiseless soft brake	•	•	–	•	•	•	–	–	–
High-speed version	•	•	•	–	•	–	–	–	–
Rated current (A)	0.9	0.6	0.9	0.6	0.9	0.9	0.9	1.2	1.3
Rated power consumption (W)	200	140	200	140	200	200	200	270	300
Operating time (min. S2)	5	4	4	4	5	4	4	5	4
Length C (mm)	537	477	527	477	537	537	527	557	557
Length D (mm)	520	460	510	460	520	520	510	540	540
Length E (mm)	elero head = 14								
Weight (kg)	1.9	1.9	1.9	1.9	1.9	1.9	2.4	2.4	2.4

Accessories, such as connection and assembly cables, adapter sets and motor bearings, can be found in the section “RevoLine M accessories” on page 72.
Suitable control systems as well as radio transmitters and sensors can be found in the section “Home automations” on page 138.

VariEco M / VariEco+ M

Tubular drives for roller shutters
and textile sun protection



Mechanical limit switches, VariEco+ with quick adjustment,
min. shaft size $\varnothing = 50$ mm, noiseless soft brake up to 20 Nm.

elero head – wired

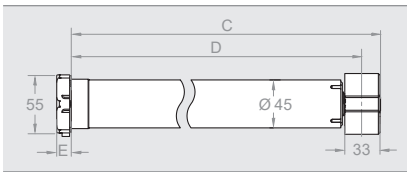

elero head	M6/35	M7/23		M10	M12/23	M20	M30/10	M30	M40	M50
Item number	34 937.0101	34 925.0101		34 921.0101	34 935.0101	34 931.0101	34 943.0101	34 941.0101	34 951.0101	34 961.0101

elero head	+ M6/35	+ M7/23	+ M9/35	+ M10	+ M12/23	+ M20	+ M30/10	+ M30	+ M40	+ M50
Item number	34 937.0001	34 925.0001	34 947.0001	34 921.0001	34 935.0001	34 931.0001	34 943.0001	34 941.0001	34 951.0001	34 961.0001

Technical data

Rated torque (Nm)	6	7	9	10	12	20	30	30	40	50
Rated speed (Upm)	35	23	35	14	23	14	10	14	14	14
Rated voltage (V)	1 ~ 230	1 ~ 230	1 ~ 230	1 ~ 230	1 ~ 230	1 ~ 230	1 ~ 230	1 ~ 230	1 ~ 230	1 ~ 230
Rated frequency (Hz)	50	50	50	50	50	50	50	50	50	50
Noiseless soft brake	•	•	–	•	•	•	–	–	–	–
high-speed version	•	•	•	–	•	–	–	–	–	–
Rated current (A)	0.9	0.6	0.9	0.6	0.9	0.9	0.9	0.9	1.2	1.3
Rated power consumption (W)	200	140	200	140	200	200	200	200	270	300
Operating time (min. S2)	5	4	4	4	5	4	4	4	5	4
Length C (mm)	537	477	527	477	537	537	527	527	557	557
Length D (mm)	520	460	510	460	520	520	510	510	540	540
Length E (mm)	elero head = 14									
Weight (kg)	1.9	1.9	1.9	1.9	1,9	1.9	2.4	2.4	2.4	2.4

Accessories, such as connection and assembly cables, adapter sets and motor bearings, can be found in the section “RevoLine M accessories” on page 72. Suitable control systems can be found in the section “Wall-mounted devices” on page 214.

VariEco M NHK

Tubular drives with emergency crank handle



Mechanical limit switches, min. shaft size $\varnothing = 50$ mm, noiseless soft brake up to 20 Nm, NHK operation with 7 mm hexagonal and 6 mm square shaft.

NHK head

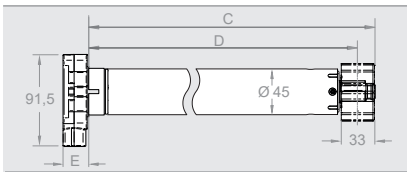

NHK head	M20 NHK	M30 NHK	M40 NHK	M50 NHK
Item number	34 833.0001	34 843.0001	34 853.0001	34 863.0001

Technical data

Rated torque (Nm)	20	30	40	50
Rated speed (Upm)	14	14	14	14
Rated voltage (V)	1 ~ 230	1 ~ 230	1 ~ 230	1 ~ 230
Rated frequency (Hz)	50	50	50	50
Noiseless soft brake	•	–	–	–
Rated current (A)	0.90	0.90	1.05	1.30
Rated power consumption (W)	200	200	242	300
Operating time (min. S2)	4	4	5	4
Length C (mm)	661	651	681	681
Length D (mm)	639	629	659	659
Length E (mm)	26	26	26	26
Weight (kg)	2.2	2.5	2.7	3.1

Compatible accessories	Assembly kit (includes 16 x 16 mm motor bolts and adjustment aid)
Item number	23 162.0201

Accessories, such as connection and assembly cables, adapter sets and motor bearings, can be found in the section “Accessories for RevoLine M NHK” on page 79. Suitable control systems can be found in the section “Wall-mounted devices” on page 214.

Tubular drives for specific requirements

In an emergency, e.g. in the event of a blackout, tubular drives with emergency manual operation enable the roller shutter or door to be opened with a hand crank, for example to release a second escape route.

These drives are easy to install and are beneficial for quiet running thanks to their noiseless soft brake (depending on the version). Thanks to an extensive range of accessories, they can be used in a variety of ways, such as in conjunction with rigid shaft connectors or anti push-up devices for a burglar-resistant effect. Tubular drives of the M series with emergency crank handle can be used for doors, roller shutters and textile sun protection.



Cables and accessories

The return of connecting cables is not possible!



23 395.0201

Connection cable without drive, **white**

Item number	Type/Item Description
23 615.2501	0.2 m pluggable
23 395.0201	2.0 m pluggable
23 395.0301	3.0 m pluggable
23 395.0401	5.0 m pluggable
23 395.0501	10.0 m pluggable
23 395.0901	15.0 m pluggable
23 395.0601	20.0 m pluggable
23 395.2601	QuickConnect mit MiniPlug, IP 65 cable length 0.25 m
23 395.0101	0.4 m, pluggable with Hirschmann plug STAS3, light grey, moulded on
23 395.0801	2.0 m, pluggable with Hirschmann plug STAS3, light grey, screwed on
23 615.2401	0.2 m adapter cable, type 9/RevoLine

Assembly and connection cables and accessories

Item number	Type/Item Description
23 395.8502	Assembly cable
13 710.5101	Fast clamp as replacement for assembly cable 23 395.8501
23 285.1201	Cable adapter, 0.25 m, 4-core/STAK3
23 395.2701	QuickConnect, fast connection system, IP 65
23 395.4701	QuickConnect, set of 10
23 846.0001	Hirschmann plug STAS3 (motor side), light grey with bracket
13 701.5301	Hirschmann coupling STAK3 (connection side), light grey
23 999.1001	Hirschmann plug STAS3 (motor side), with clip, black
13 703.1001	Hirschmann plug STAK3 (connection side), black
13 308.0001	Flexible adjustment aid
23 375.6001	Wire jumper for Hirschmann plug for radio motors
13 308.4201	Rubber grommet



23 395.0101

Connection cable without drive, **black**

Item number	Type/Item Description
23 395.6101	0,5 m pluggable halogen-free
23 395.2201	2.0 m pluggable
23 395.2301	3.0 m pluggable
23 395.9301	3.0 m pluggable halogen-free
23 395.2401	5.0 m pluggable
23 395.9401	5.0 m pluggable halogen-free
23 395.2501	10.0 m pluggable
23 395.9501	10.0 m pluggable halogen-free
23 395.4001	10.0 m pluggable halogen-free with grommet
23 395.2101	0.4 m, pluggable with Hirschmann plug STAS3, light grey, moulded on
23 395.8101	0.4 m, pluggable with Hirschmann plug STAS3, light grey, moulded on, halogen-free
23 395.2901	2.0 m pluggable with Hirschmann plug STAS3, black, screwed on



23 395.8502



23 285.1201



13 308.0001



23 395.2701



23 395.2601

Assembly and disassembly must be carried out only in a de-energised state!
The connections to the 230 V mains must be made by authorised specialist personnel.

Drive adapters

Profiles of the adapter sets in 1:1 scale can be found on page 256.

Item number	Type/Item Description	Notch tubes	Round tubes	Profile tubes
23 041.0001	Ø 57 mm, Ates, MHZ	•		
23 055.0001	Ø 60 mm, AXE, Griesser, Hüppe	•		
22 086.0001	60 mm, Stobag	•		
23 042.0001	Ø 62 x 0.6 mm, DEPRAT F2000	•		
23 031.0001	Ø 63 x 1.0 mm	•		
22 019.0001	Ø 63 mm, deep notch, Giallo, Bat	•		
23 018.0001	Ø 70 mm, IMBAC, Ahlquist, round notch	•		
23 020.0001	Ø 70 mm, Flachnut-Welser, Griesser	•		
23 065.0001	Ø 70 mm	•		
23 054.0001	Ø 71 x 1.5 mm, Hassinger	•		
23 015.0001	Ø 78 x 1.0 mm 78 x 1.25 mm, flat and round notch, MHZ	•		
22 129.0001	Ø 78 x 1.0 mm, Welser flat and round notch for ZIP systems (NOT for VariEco, VariEasy)	•		
23 026.0001	Ø 78 x 1.0 mm Rau	•		
22 088.0001	Ø 80 x 1.0 mm and Ø 80 x 1.25 mm, Welser	•		
23 017.0001	Ø 85 x 1.0 mm	•		
22 059.0001	Ø 85 x 1.0 mm, conductive	•		
23 048.0001	Ø 85 x 1.2 mm, Imbac-NEW, Griesser	•		
22 060.0001	Ø 85 x 1.2 mm, Imbac-NEW, conductive	•		
23 053.0001	Ø 90 mm, Le Profil, Ø 89 mm DEPRAT	•		
23 058.0001	Ø 90,5 x 1.25 mm, MHZ	•		
22 095.0001	101,5 x 1.25 / 102,2 x 1.6 mm, Welser, SWS	•		
13 116.2901	Ø 50 x 1.5 mm		•	
13 116.9901	Ø 50 x 1.5 mm, Siral		•	
23 044.0001	Ø 60 x 1.5 mm and Ø 62 x 2.0 mm		•	
23 045.0001	Ø 63 x 1.5 mm		•	
23 046.0001	Ø 70 x 1.5 mm		•	
23 093.0001	Ø 83 x 1.5 mm (with profile)		•	
23 052.0001	Ø 98 x 2.0 mm and Ø 102 x 3.5 mm		•	
23 051.0001	Ø 102 x 1.5 mm and Ø 102 x 2.0 mm		•	
13 117.8501	Ø 50 mm, Soprofen, Hella TopSafe			•
13 121.9301	Ø 50 mm, with ribs			•
23 012.0001	Octagonal shaft, size 50, Selve			•
13 119.1801	52 mm, Silent Gliss			•
23 091.0001	Ø 53 mm, Deprat			•
13 116.1001	Ø 54 mm, Zurflüh-Feller			•
23 039.0001	Ø 55 mm			•
23 050.0001	Ø 58 mm Alu, Termo Perco			•
23 036.0001	Octagonal shaft, size 60, IMBAC			•
23 379.0001	Octagonal shaft, size 60, Selve, Döhner Eckermann			•
23 056.0001	Octagonal, 60 mm, Bonfante			•
23 047.0001	Hexagonal, Ø 60 x 0.7 mm, Butzbach, Mäule			•
23 049.0001	Ø 60 mm Alu-Plast, Kittelberger, Ø 63 x 1.5 mm			•
23 043.0001	Ø 62 mm, Le-Profil, Krülland			•
23 380.0001	Ø 64 mm, Zurflüh-Feller			•
23 032.0001	Ø 65 mm, IMBAC, Eckermann, Metallpress			•
23 033.0001	Ø 65 mm, Hoos			•
23 057.0001	Ø 67 x 1.5 mm, MHZ			•
23 011.0001	Octagonal shaft, size 70, Selve, Döhner, Eckermann			•
23 059.0001	Hexagonal, 75 mm, Butzbach, Mäule			•
23 034.0001	Ø 76 x 1.2 mm, Kittelberger, Wiral			•
23 090.0001	Pentagonal, 78 mm, meimo			•
23 040.0001	78x1 / 78x1.25 mm profile tube Döhner, Hass. 58			•
23 382.0001	Ø 80 mm, Zurflüh-Feller			•
23 028.0001	Adapter for Somfy adapter set, max. 40 Nm (for Somfy and Simu 50 mm motor couplings)			
13 105.6901	Adapter ring for M drives with L adapter sets			
13 106.9201	Adapter ring for M drives with L-RH adapter sets			
13 115.9901	Coupling remover			



23 028.0001



RevoLine motor bearing for elero head

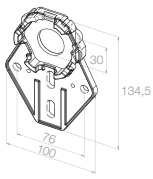

23 004.0001
Universal motor bearing (plastic)
Torque limitation of max. 50 Nm

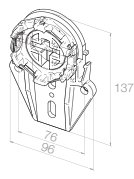

23 615.4401
Universal motor bearing, disengageable, torque limitation, max. 30 Nm

236154401.001
Sales unit: 25 pieces

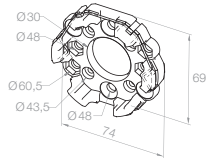

23 003.0001
Pitch circle 48/60 (aluminium)

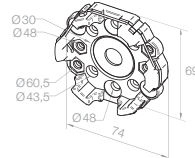

23 003.0201
Pitch circle 48/60 (aluminium) with 4xM6 nuts and centring

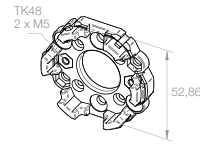

23 003.0401
Pitch circle of 48 mm with 2xM5 nuts, pitch circle of 60 mm

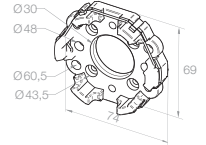

23 003.0301
Pitch circle 48/60 with M6/M8 thread - for awnings -

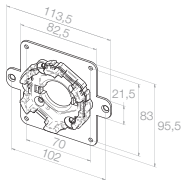

23 004.0101
Motor bearing for SKS torque limitation of max. 50 Nm

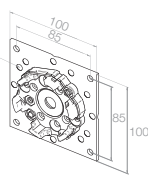

23 615.9901
Base plate for motor bearing, e.g. for VEKA variant element

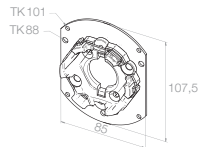

23 615.7101
Mounting plate with plastic bearing up to max. 30 Nm (Thyssen, Schüco, Veka, Home)

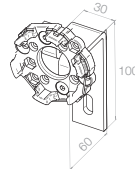

23 615.9101
Motor bearing, cranked, up to max. 50 Nm (60 mm wall distance)

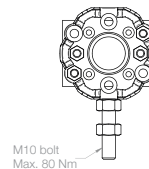

23 615.3501
Special bolt bearing with height adjustment with M10 bolt, max. 80 Nm

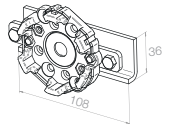

23 615.7201
Clamp bearing for roller bearing bracket, torque limitation of up to max. 30 Nm

Screwless, left

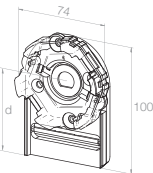

23 615.8201
For built-in roller shutters, size 137 mm, d = 64 - 65.5 mm, up to max. 30 Nm

Screwless, right

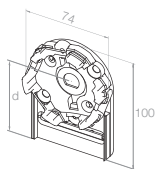

23 615.9201
For built-in roller shutters, size 137 mm, d = 64 - 65.5 mm, up to max. 30 Nm

Screwless, left

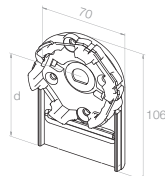

23 615.8301
For built-in roller shutters, size 150 mm, d = 70.7 mm, up to max. 30 Nm

Screwless, right

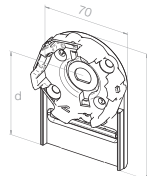

23 615.9301
For built-in roller shutters, size 150 mm, d = 70.7 mm, up to max. 30 Nm

Screwless, left

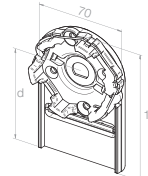

23 615.8401
For built-in roller shutters, size 165 mm, d = 78.2 - 79.7 mm, up to max. 30 Nm

Screwless, right

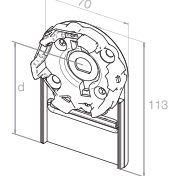

23 615.9401
For built-in roller shutters, size 165 mm, d = 78.2 - 79.7 mm, up to max. 30 Nm

Screwless, left + right



23 003.1601
For Heroal elements FMR/FME/FMB Size 125-205 mm up to max. 30 Nm

Screwless, left



23 003.1501
For Heroal elements FMR/FME/FMB Size 125-205 mm

Screwless, right



23 003.1401
For Heroal elements FMR/FME/FMB Size 125-205 mm

Mounting and adapter plates for elero head



Adapter plates

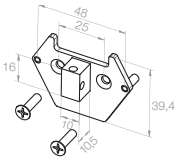

23 374.1401
10 x 16 mm, short pin,
10.5 mm (up to 50 Nm)

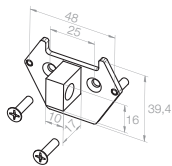

23 374.1501
10 x 16 mm, long pin,
17 mm (up to 50 Nm)

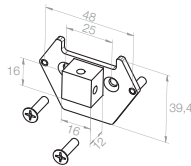

23 374.2101
16 x 16 mm,
12 mm pin

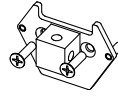

23 374.8901
16 x 16 mm,
14 mm pin,
max. torque of 50 Nm

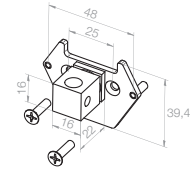

23 374.2501
16 x 16 mm,
22 mm pin
(for replacement of
type 11 motors)

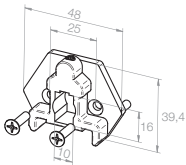

23 374.6801
For type 9 built-in roller
shutter motor bearings
(up to 50 Nm)
(increases the lateral
deduction dimension by
approx. 11 mm)



23 375.8001
Adapter with positive
locking, compatible with
Rademacher bearing,
max. 50 Nm torque

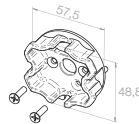

23 374.9401
SH adapter
(up to 50 Nm)
Compatible with Somfy
and Selve star head
bearings

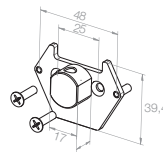

23 374.9801
Adapter plate with bolt,
Ø 19.5 mm
Compatible with Becker
bearing

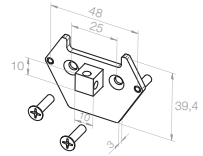

23 374.1601
10 x 10 mm,
9.5 mm pin
(up to 30 Nm)

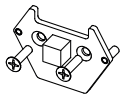

23 374.9501
10 x 10 mm, 9.5 mm pin
(up to 30 Nm) without bore

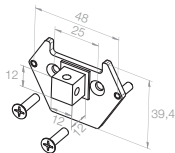

23 374.3301
Adapter plate, 12 x 12 mm,
Height of 12 mm,
up to 50 Nm

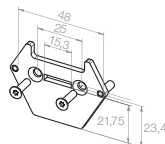

23 374.7301
Adapter plate with slot
3 x 15 mm
(Faber-Benthin)

Fixing screws



10 101.3608
Fixing screw for adapter
plates for plastic heads,
PT screw,
K 40 x 16



10 101.0947
Fixing screw for adapter
plates for aluminium
heads, Remform,
Ø 3.5 x 12 (Torx 15)

16 x 10 mm motor bearing in conjunction with bolt 23 374.7901 (RH drives) or elero head in conjunction with adapter plate 23 374.1401

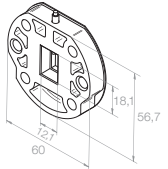
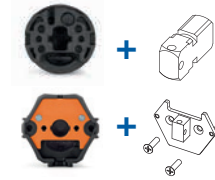

23 986.0001
Wall anchor, latching,
Pitch circle of 48 mm

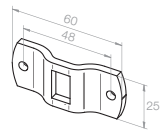

13 300.0801
Wall anchor, M6 thread,
pitch circle of 48 mm

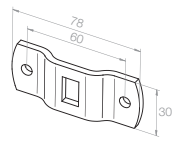

13 106.1701
Wall bracket, cranked,
Pitch circle of 60 mm

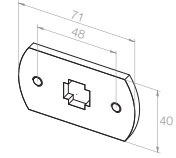

13 301.7001
Wall bracket, flat,
Pitch circle of 48 mm

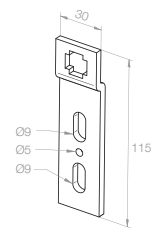

13 301.4601
Wall anchor, cross,
Closed

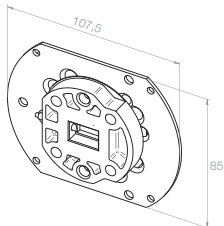

23 276.0001
Mounting plate with motor
bearing (Thyssen, Schüco,
Veka, Home)

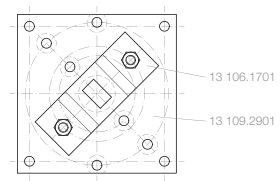

23 832.0001
Base plate
with motor bearing

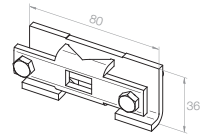

23 965.0003
Clamp bearing for roller
bearing bracket or for
plaster-over wall bracket

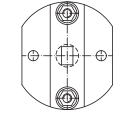

23 985.0001
Shock mount
Wall bearing

Bolt for RH head



Pin

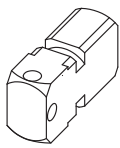

23 374.7901
10 x 16 mm, RH
Incl. grub screw

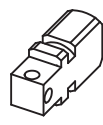

23 375.0601
10 x 10 mm, RH
Incl. grub screw,
max. 30 Nm

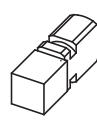

23 375.0101
12 x 12 mm, RH
Incl. grub screw

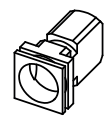

23 375.1101
16 x 16 mm, RH
Incl. grub screw,
special bolt for
Roma XP

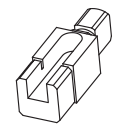

23 375.0701
20 x 20 mm, RH
Incl. grub screw

Direct attachment, RH head

	Up to max. 20 Nm	Up to max. 50 Nm
Number of screws	2*	4**
Maximum tightening torque (Nm)	2.0	5.5
Screw openings For fastening (marked orange)		

* Countersunk screws, 3.5 x 12, Remform F Torx 15
(item no. 10 101.0947)

** PT screws, K 5.0 x 16, Torx 20 (item no. 10 101.3623)

Motor bearing for SH drives



23 003.1701
Motor bearing with
Safety clip
(small eyelet), TK 48

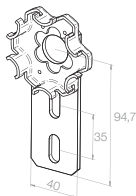

23 003.1801
Motor bearing without
Safety clip



13 123.4501
Safety clip with big
eyelet



23 617.5001
Universal bearing
SH, disengageable
Max. 30 Nm

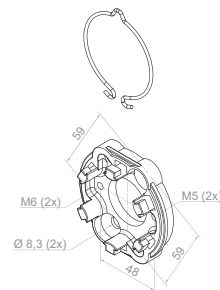

23 617.6001
Awning bearing with
safety clip (small
eyelet)

Wall bearings / mounting plates

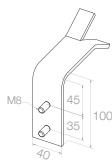

13 300.9202
Plaster bearing,
up to max. 80 Nm

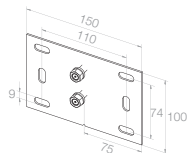

24 554.0001
Mounting plate
for universal bearings
(23 004.0001 and
23 615.4401)

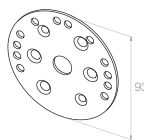

13 302.7801
Mounting plate
for motor bearings
Pitch circle of 78 mm
E.g. for Weru elements

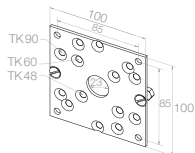

23 687.0501
Base plate with
2 retractable
M6 x 16 screws
and nuts

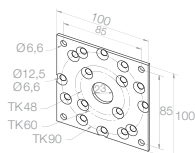

13 109.2902
Base plate with
pitch circle of 48/60/90 mm
(without motor bearing and
screws)

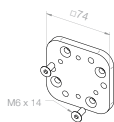

23 687.0401
Spacer plate,
aluminium, black,
with 2x M6 x 14 mm

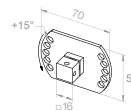

23 687.0201
NHK motor attachment,
16 x 16 mm for variable
angle in 15° increments

Fixing clips

Angle bracket

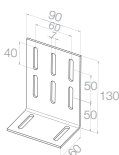

13 110.5101
130 mm high

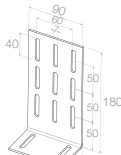

13 110.5201
180 mm high

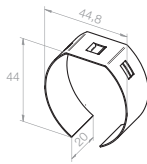

13 301.8501
For T-spring
50 mm, octagonal shaft

Cables and accessories for NHK drives

The return of connecting cables is not possible!



Connection cable without drive, **white**

Item number	Type/Item Description
23 615.0201	2.0 m pluggable
23 615.0301	3.0 m pluggable
23 615.0401	5.0 m pluggable
23 615.0501	10.0 m pluggable
23 615.0601	20.0 m pluggable
23 615.0101	0.4 m pluggable with Hirschmann plug



23 615.0201



23 615.0101



23 395.8502



23 285.1201



23 846.0001

Hirschmann plug, motor side

Item number	Type/Item Description
23 846.0001	STAS3 with bracket, light grey
23 999.1001	Hirschmann plug STAS3, black with bracket

Assembly and connection cables and accessories

Item number	Type/Item Description
23 395.8502	Assembly cable
13 710.5101	Quick clamp as replacement for assembly cable 23 395.8501
23 285.1201	Cable adapter, 0.25 m, 4-core/STAK3



13 701.5301



13 701.1001

Hirschmann couplings, connection side

Item number	Type/Item Description
13 701.5301	STAK3, light grey
13 703.1001	STAK3, black



23 395.2701 and 23 395.4701

Assembly and connection cables and accessories

Item number	Type/Item Description
23 395.2701	QuickConnect, quick connection system, IP 65
23 395.4701	QuickConnect, set of 10
13 308.0001	Flexible adjustment aid

Assembly and disassembly must be carried out only in a de-energised state! The connections to the 230 V mains must be made by authorised specialist personnel.



13 308.0001

Motor bearing for NHK drives

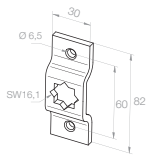

13 106.3501
Motor bearing,
16 x 16 mm,
pitch circle of
60 mm, cranked

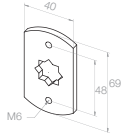

13 103.3901
Motor bearing,
16 x 16 mm,
pitch circle of
48 mm, flat

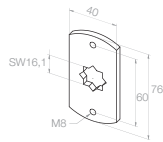

13 103.4001
Motor bearing,
16 x 16 mm,
pitch circle of
60 mm, flat

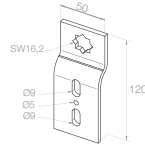

13 301.0801
Motor bearing,
16 x 16 mm,
upright, star

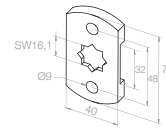

13 110.5601
Spacer plate
for 13 103.3901
(cannot be used as
motor bearing)

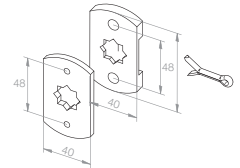

23 109.0001
Motor bearing, flat,
16 x 16 mm,
pitch circle Ø 48 mm
with plastic spacer plate
and split pin (includes
no. 13 103.3901 and
13 110.5601)

Plaster motor bearing

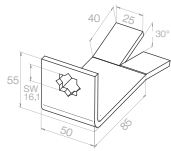

13 300.8501
Plaster motor bearing,
16 x 16 mm

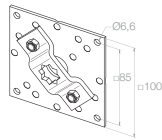

23 833.0001
Base plate with
motor bearing,
16 x 16 mm,
pitch circle of 48,
60, 90 mm

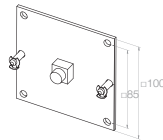

23 800.0001
NHK motor
bearing plate

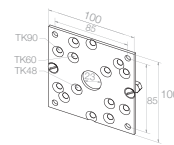

23 687.0501
Base plate with
two retractable M6 x 16
screws and nuts

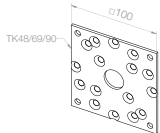

13 109.2902
Adapter plate with
pitch circle of 48/60/90
mm, without motor
bearing and screws

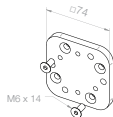

23 687.0401
Spacer plate,
aluminium, black,
with 2x M6 x 14 mm

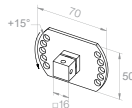

23 687.0201
NHK motor mounting,
16 x 16 mm for variable
angle in 15° increments

Assembly kit for NHK drives

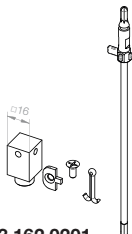

23 162.0201
Assembly kit for NHK motors,
type VariEco NHK
(includes motor bolts,
16 x 16 mm and adjustment aid)



23 162.0801
Assembly kit for NHK motors,
type RolTop/D+ NHK
(includes 16 x 16 mm motor bolts)

Manual operation

Crank handles

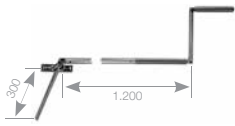

23 764.0002
Hinged crank with joint bearing (45°) and 7 mm, hexagonal



23 731.0002
Joint bearing with awning eyelet



23 771.0002
7 mm, hexagonal with awning eyelet, 175 mm long



23 771.0102
7 mm, hexagonal with awning eyelet, 460 mm long

23 771.0301
7 mm, hexagonal with awning eyelet, 600 mm long



12 300.0901
Crank with awning hook, length of 1.4 m

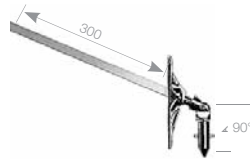

23 772.0002
Joint bearing (45°) for crank with adapter cone

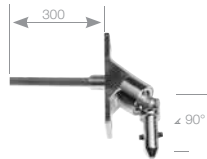

23 342.0001
Joint bearing (90°) for crank with adapter cone

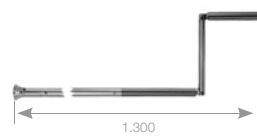

23 773.0001
Hinged crank with adapter cone

NMA adapter set



23 199.5701
Adapter, 7 mm, hex. for M/L NHK
Suitable for drive shaft, extensible

NMA basic set



23 199.9501
Consisting of angle drive / drive shaft / crank



23 081.0001
Drive shaft, extensible 1.70 - 3.00 m

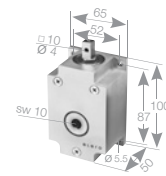

23 030.0001
Angle drive



13 305.8001
Crank handle for angle drive

TA0-RD/X safety brake

For left or right-hand installation, suitable for built-in roller shutters



24 031.0001
TA0-RD/X
Maximum torque of 147 Nm, maximum operating speed of 22 rpm with damping and el. cut-out

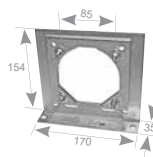

24 040.0001
Pedestal bearing bracket, complete for TA0-RD/X

Adapter TA0-RD/X (always order 2 pieces)



Item number	Type/Item Description	Notch tubes	Round tubes	Profile tubes
13 116.9201	Ø 57 mm, Ates	•		
13 117.0701	Ø 60 mm, AXE, Griesser, Hüppe	•		
13 116.9301	Ø 62 x 0.6 mm, DEPRAT F 2000	•		
13 116.7101	Ø 63 x 1.0 mm	•		
13 116.4502	Ø 70 mm, IMBAC, Ahlquist	•		
13 116.4602	Ø 70 mm, Griesser	•		
13 117.2701	Ø 70 mm	•		
13 117.0601	Ø 71 x 1.5 mm	•		
13 114.8701	Ø 78 x 1.0 mm/78 x 1.25 mm, flat notch MHZ	•		
13 116.9101	Ø 78 x 1.0 mm, Döhner	•		
13 117.5301	Ø 78 x 1.0 mm/1.25 mm	•		
13 114.7601	Ø 85 x 1.0 mm	•		
13 117.0001	Ø 85 x 1.2 mm, IMBAC-New, Griesser	•		
13 117.0501	Ø 90 mm, Le Profil und Ø 89 mm, DEPRAT	•		
13 116.2901	Ø 50 x 1.5 mm		•	
13 116.9901	Ø 50 x 1.5 mm, Siral		•	
13 116.9501	Ø 60 x 1.5 mm and Ø 62 x 2.0 mm		•	
13 116.9601	Ø 63 x 1.5 mm		•	
13 116.9701	Ø 70 x 1.5 mm		•	
13 117.2801	Ø 70 x 2.0 mm		•	
13 117.7101	Ø 83 x 1.5 mm (with profile)		•	
13 117.0301	Ø 102 x 1.5 mm and Ø 102 x 2.0 mm		•	
13 117.0401	Ø 102 x 3.5 mm und Ø 98 x 2.0 mm		•	
13 117.1001	Ø 90,5 x 1.25 mm MHZ		•	
13 117.8501	Ø 50 mm, Soprofen			•
13 115.9501	Octagonal shaft, size 50, Selve			•
13 117.8301	Ø 53 mm, Deprat			•
13 116.1001	Ø 54 mm, Zurflüh-Feller			•
13 116.9001	Ø 55 mm, elero			•
13 117.0201	Ø 58 x 1.5 mm Alu, Termo Perco			•
13 116.8302	Octagonal shaft, size 60, Selve, IMBAC			•
13 117.0801	Octagonal, 60 mm, Bonfante			•
13 116.9801	Hexagonal, 60 x 0.7 mm, Butzbach, Mäule			•
13 117.0101	Ø 60 mm, Alu-Plast, Kittelberger, Ø 63 x 1.5 EHAGE			•
13 116.9401	Ø 62 mm Le-Profil, Krülland			•
13 114.8301	Ø 64 mm, Zurflüh-Feller			•
13 116.7401	Ø 65 mm, IMBAC, Eckermann, Metallpress			•
13 116.7501	Ø 65 mm, Hoos			•
13 117.0901	Ø 67 x 1.5 mm, MHZ			•
13 115.9301	Octagonal shaft, size 70 Selve, Döhner, Eckermann			•
13 117.1101	Hexagonal, 75 mm, Butzbach, Mäule			•
13 116.7601	Ø 76 x 1.2 mm, Kittelberger, Wiral			•
13 117.8001	Pentagonal, 78 mm, Meimo			•
13 114.8501	Ø 80 mm, Zurflüh-Feller			•
13 117.8601	Hexagonal shaft Ø 80 mm, Butzbach			•

MiniClick and MaxiClick rigid shaft connectors

Universal for size 40, 50, 60 and 70, octagonal shafts



MiniClick, with twist lock

For mini profiles and octagonal shafts, size 40, 50 (0.6 and 0.8 mm) and size 60 (0.6 and 0.9 mm)

Item number	Type/Item Description
13 309.0001	MiniClick, 1-membered
13 309.0101	MiniClick, 2-membered
13 309.0201	MiniClick, 3-membered
13 309.0301	MiniClick, 4-membered
13 309.0401	MiniClick slide-in profile
13 309.0501	MiniClick compensation profile

MaxiClick, with twist lock

For standard/new construction profiles and octagonal shafts, size 60 (0.9 mm) and size 70 (1.0/1.2 and 1.5 mm)

Item number	Type/Item Description
13 309.1001	MaxiClick, 1-membered
13 309.1101	MaxiClick, 2-membered
13 309.1201	MaxiClick, 3-membered
13 309.1401	MaxiClick slide-in profile
13 309.1501	MaxiClick compensation profile

Determination of the suitable MiniClick shaft connector

Shaft connector	With box depth B1 (mm)	Number per blind	Blind weight (kg)	Application range
1-membered	115 – 150	One rigid shaft connector per 60 cm shaft length or 4 Nm motor output	Max. 8 per shaft connector	Mini- / Maxi-profile ¹
2-membered	155 – 180			
3-membered	185 – 210			
4-membered	215 – 240			

Determination of the suitable MaxiClick shaft connector

Shaft connector	With box depth B1 (mm)	Number per blind	Blind weight (kg)	Application range
1-membered	125 – 160	One rigid shaft connector per 60 cm shaft length or 6 Nm motor output.	Max. 12 per shaft connector	Mini- / Maxi-profile ¹
2-membered	160 – 200			
3-membered	200 – 250			

¹ Values depend, among other things, on the shaft type.

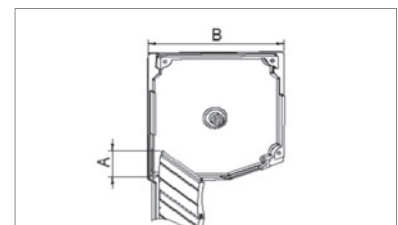

The top profile bar of the roller shutter should not protrude from the guide rail by more than 1/2 of the profile height (A). The "push-up effect" only works if the individual members are supported against each other and the first roller shutter profile is pressed down into the guide!

Anti push-up devices

Miniprofil anti push-up devices

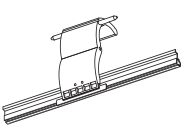

13 301.8901
2-membered

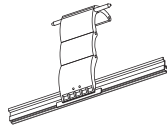

13 301.9101
3-membered

Standard profile anti push-up devices

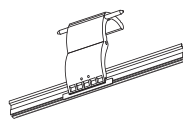

13 301.8801
2-membered
Standard profile

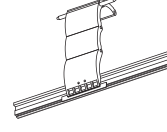

13 301.9001
3-membered
Standard profile

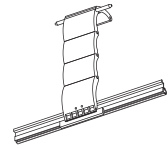

13 301.9201
4-membered
Standard profile

Attachment rings

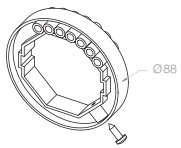

13 301.9501
For 60 mm,
octagonal shaft

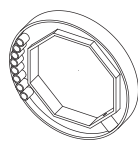

13 301.9601
For 70 mm
Octagonal shaft

elero

RevoLine L Tubular drives

RoITop L RH /-868	88.
SunTop L RH /-868	92.
VariEco L RH	96.
VariEco L NHK	97.
RevoLine L accessories	98.

RoITop L-868 RH / RoITop L RH



With a diameter of 58 mm, the powerful tubular drives of the RoITop L series are designed for large roller shutters. They are available both with and without an integrated radio system. Drives from 40 to 120 Nm are

available with 11 or 14 rpm, depending on the version. All drives can be easily installed and adjusted in a time-saving manner.

RoITop L RH drives are available with the following drive heads:

Round head

- Round head (with square bolt or SH adapter)
- Wrap-around round motor head

Radio control



Wired



Bidirectional routing with ProLine 2



ProLine 2, the bidirectional radio system from elero, is more reliable, powerful and transparent than unidirectional radio standards.

At the heart of the technology (868 MHz) are bidirectional radio components

(transceivers) that are capable not only of receiving, but also of confirming and relaying the signals. As soon as a command has been executed on the drive, the user receives feedback and can be sure that the commands are being executed correctly.



Applications	RoI Top L-868 RH RoI Top L RH
Page	88/89
Roller shutters	•
Large blinds	•

TOP functions	RoI Top L-868 RH RoI Top L RH
Special features	Round head
Mechatronic limit position detection with soft cut-out	•
Intelligent force measurement	•
Release can be activated at end position	•
End positions can be set with assembly cable and/or hand-held transmitter	•
Upward/downward blind protection and free travel	•

Technical data	RoI Top L-868 RH RoI Top L RH
Rated torque (Nm)	40 to 120
Rated speed (Upm)	11, 14
Min. shaft diameter (mm)	63
Diameter (mm)	58
Length (mm)	from 568
Protection class (IP)	44
Limit switch range (rev.)	40
Ambient operating temperature (°C)	-20 to +60
Conformity	CE
Plug-in connection cable, 2.0 m	•

End position programming		RoI Top L-868 RH RoI Top L RH
Top	Bottom	
To stop	Freely adjustable	•
Freely adjustable	To stop	•
To stop	To stop	•
Freely adjustable	Freely adjustable	•

RolTop L-868 RH

Tubular drives for roller shutters



works with
Yubii® Home

Mechatronic limit position detection with soft cut-out, intelligent force measurement, upward/downward blind protection and free travel (drive-specific), activatable release at end position, end positions can be set with assembly cable or hand-held transmitter, min. shaft size $\varnothing = 63$ mm, bidirectional radio control (868 MHz) with automatic routing function and feedback, round motor head.

Round head RH – radio control

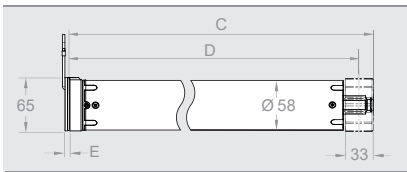



Round head RH 	L40-868 RH	L60-868 RH	L80-868 RH	L100-868 RH	L120-868 RH
Item number	36 724.0001	36 734.0001	36 744.0001	36 754.0001	36 764.0001

Technical data

Rated torque (Nm)	40	60	80	100	120
Rated speed (Upm)	14	14	14	11	11
Rated voltage (V)	1 ~ 230	1 ~ 230	1 ~ 230	1 ~ 230	1 ~ 230
Rated frequency (Hz)	50	50	50	50	50
Rated current (A)	1.45	1.55	1.80	1.70	2.00
Rated power consumption (W)	333	356	415	390	460
Operating time (min S2)	4	4	4	4	4
Length C (mm)	563	563	593	593	593
Length D (mm)	546	546	576	576	576
Length E (mm)	5	5	5	5	5
Weight (kg)	4.3	4.3	4.8	4.8	4.8

Compatible accessories

Item number	Square bolt, 16 x 16 23 375.1501	
Item number	SH adapter (max. 80 Nm) Somfy and Selve bearing compatible 23 375.0901	

Accessories, such as connection and assembly cables, adapter sets and motor bearings, can be found in the section "Accessories for RevoLine L RH / NHK" on page 98. Suitable control systems and radio transmitters and sensors can be found in the section "Home automations" on page 138.

RoITop L RH

Tubular drives for roller shutters



Mechatronic limit position detection with soft cut-out, intelligent force measurement, upward/downward blind protection and free travel (drive dependent), activatable release at end position, end positions can be set with assembly cable, min. shaft size $\varnothing = 63$ mm, round motor head.

Round head RH - wired

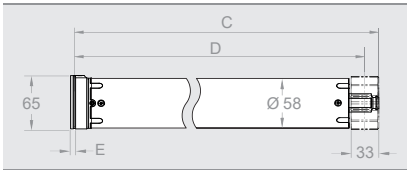



Round head RH 	L40 RH	L60 RH	L80 RH	L100 RH	L120 RH
Item number	36 723.0001	36 733.0001	36 743.0001	36 753.0001	36 763.0001

Technical data

Rated torque (Nm)	40	60	80	100	120
Rated speed (Upm)	14	14	14	11	11
Rated voltage (V)	1 ~ 230	1 ~ 230	1 ~ 230	1 ~ 230	1 ~ 230
Rated frequency (Hz)	50	50	50	50	50
Rated current (A)	1.45	1.55	1.80	1.70	2.00
Rated power consumption (W)	333	356	415	390	460
Operating time (min S2)	4	4	4	4	4
Length C (mm)	563	563	593	593	593
Length D (mm)	546	546	576	576	576
Length E (mm)	5	5	5	5	5
Weight (kg)	4.3	4.3	4.8	4.8	4.8

Compatible accessories

	Square bolt, 16 x 16
Item number	23 375.1501 
	SH adapter (max. 80 Nm) Somfy and Selve bearing compatible
Item number	23 375.0901 

Accessories, such as connection and assembly cables, adapter sets and motor bearings, can be found in the section "Accessories for RevoLine L RH / NHK" on page 98. Suitable control systems can be found in the section "Wall-mounted devices" on page 214.

SunTop L-868 RH / SunTop L RH



With a diameter of 58 mm, the powerful tubular drives of the SunTop L series are ideal for textile sun protection. They are available both with and without an integrated

radio system. Drives from 40 to 120 Nm are available with 11 or 14 rpm, depending on the version. The drives can be easily installed in a time-saving manner.

SunTop L RH drives are available with the following drive heads

Round head

- Round head (with square bolt or SH adapter)
- Wrap-around round motor head

Radio control



Wired



Bidirectional routing with ProLine 2



ProLine 2, the bidirectional radio system from elero, is more reliable, powerful and transparent than unidirectional radio standards.

At the heart of the technology (868 MHz) are bidirectional radio components

(transceivers) that are capable not only of receiving, but also of confirming and relaying the signals. As soon as a command has been executed on the drive, the user receives feedback and can be sure that the commands are being executed correctly.



Applications	SunTop L-868 RH SunTop L RH
Page	92 / 93
Textile sun protection	•

TOP functions	SunTop L-868 RH SunTop L RH
Special features	Round head
Mechatronic end position detection with soft cut-out	•
Release can be activated at limit position	•
Limit positions can be set with the assembly cable and/or hand-held transmitter	•
Upward/downward blocking detection	•

Technical data	SunTop L-868 RH SunTop L RH
Rated torque (Nm)	40 to 120
Rated speed (rpm)	11, 14
Min. shaft diameter (mm)	63
Diameter (mm)	58
Length (mm)	from 568
Protection class (IP)	44
Limit switch range (rev.)	40
Ambient operating temperature (°C)	-20 to +60
Conformity	CE
Plug-in connection cable, 2.0 m	•

Limit position programming		SunTop L-868 RH SunTop L RH
Top	Bottom	
To stop	Freely adjustable	•
Freely adjustable	To stop	•
To stop	To stop	•
Freely adjustable	Freely adjustable	•

SunTop L-868 RH

Tubular drives for textile sun protection

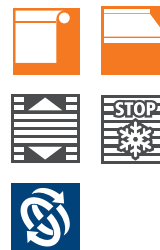

Mechatronic limit position detection with soft cut-out, intelligent force measurement, upward/downward blocking detection, activatable release at limit position, limit positions adjustable with assembly cable or hand-held transmitter, min. shaft size $\varnothing = 63$ mm, bidirectional radio control (868 MHz) with automatic routing function and feedback. Round motor head.

works with
Yubii® Home

Round head RH – radio control

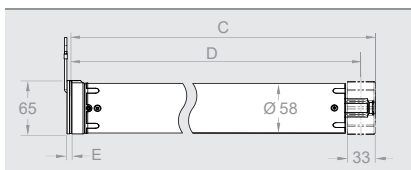



Round head RH 	L40-868 RH	L60-868 RH	L80-868 RH	L100-868 RH	L120-868 RH
Item number	36 224.0001	36 234.0001	36 244.0001	36 254.0001	36 264.0001

Technical data

Rated torque (Nm)	40	60	80	100	120
Rated speed (Upm)	14	14	14	11	11
Rated voltage (V)	1 ~ 230	1 ~ 230	1 ~ 230	1 ~ 230	1 ~ 230
Rated frequency (Hz)	50	50	50	50	50
Rated current (A)	1.45	1.55	1.80	1.70	2.00
Rated power consumption (W)	333	356	415	390	460
Operating time (min S2)	4	4	4	4	4
Length C (mm)	563	563	593	593	593
Length D (mm)	546	546	576	576	576
Length E (mm)	5	5	5	5	5
Weight (kg)	4.3	4.3	4.8	4.8	4.8

Compatible accessories

	Square bolt, 16 x 16
Item number	23 375.1501 
	SH adapter (max. 80 Nm) Somfy and Selve bearing compatible
Item number	23 375.0901 

Accessories, such as connection and assembly cables, adapter sets and motor bearings, can be found in the section “Accessories for RevoLine L RH / NHK” on page 98. Suitable control systems and radio transmitters and sensors can be found in the section “Home automations” on page 138.

SunTop L RH

Tubular drives for textile sun protection

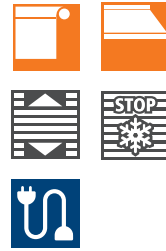

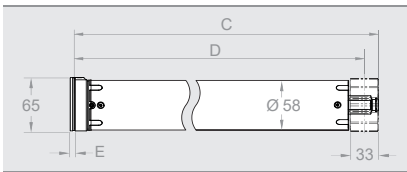

Mechatronic limit position detection with soft cut-out, intelligent force measurement, upward/downward blocking detection, activatable release at limit position, limit positions adjustable with assembly cable, min. shaft size $\varnothing = 63$ mm. Round motor head.

Round head RH – wired



Round head RH 	L40 RH	L60 RH	L80 RH	L100 RH	L120 RH
Item number	36 223.0001	36 233.0001	36 243.0001	36 253.0001	36 263.0001

Technical data					
Rated torque (Nm)	40	60	80	100	120
Rated speed (Upm)	14	14	14	11	11
Rated voltage (V)	1 ~ 230	1 ~ 230	1 ~ 230	1 ~ 230	1 ~ 230
Rated frequency (Hz)	50	50	50	50	50
Rated current (A)	1.45	1.55	1.80	1.70	2.00
Rated power consumption (W)	333	356	415	390	460
Operating time (min S2)	4	4	4	4	4
Length C (mm)	563	563	593	593	593
Length D (mm)	546	546	576	576	576
Length E (mm)	5	5	5	5	5
Weight (kg)	4.3	4.3	4.8	4.8	4.8

Compatible accessories	
Item number	<p>Square bolt, 16 x 16</p> <p>23 375.1501 </p>
Item number	<p>SH adapter (max. 80 Nm) Somfy and Selve bearing compatible</p> <p>23 375.0901 </p>

Accessories, such as connection and assembly cables, adapter sets and motor bearings, can be found in the section “Accessories for RevoLine L RH / NHK” on page 98. Suitable control systems can be found in the section “Wall-mounted devices” on page 214.

VariEco L RH / VariEco L NHK

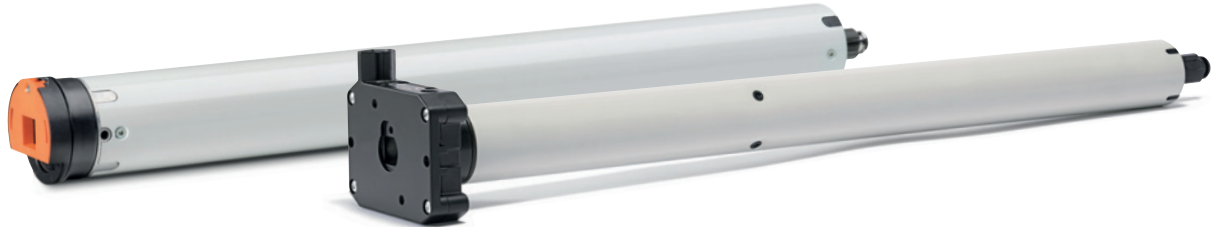

With a diameter of 58 mm, the powerful tubular drives of the VariEco L series are designed for large roller shutters and textile sun protection. Drives from 15 to 120 Nm are available with 11 to 64 rpm, depending on

the version. All drives can be easily installed and adjusted in a time-saving manner. The VariEco L NHK drives also have an emergency manual operation option with a 7 mm hexagonal crank.

VariEco L RH/NHK drives are available with the following drive heads:

Round head

- Round head (with square bolt)
- Wrap-around round motor head

Wired



NHK head (emergency crank handle)

- NHK operation with 7 mm hexagonal crank





Applications	VariEco L RH	VariEco L RH High-speed version	VariEco L NHK
Page	96	96	97
Roller shutters	•		•
Textile sun protection	•	•	•
Doors			•

TOP functions	VariEco L RH	VariEco L RH High-speed version	VariEco L NHK
Mechanical limit switch	•	•	•
Emergency manual operation with 7 mm hexagonal shaft			•

Technical data	VariEco L RH	VariEco L RH High-speed version	VariEco L NHK
Rated torque (Nm)	40 to 120	15	40 to 120
Rated speed (rpm)	11, 14	64	11, 14
Min. shaft diameter (mm)	63	63	63
Diameter (mm)	58	58	58
Length (mm)	from 568	598	from 757
Protection class (IP)	44	44	44
Limit switch range (rev.)	27	40	29
Ambient operating temperature (°C)	-20 to +60	-20 to +60	-20 to +60
Conformity	CE	CE	CE
Plug-in connection cable, 2.0 m	•	•	•

Limit position setting		VariEco L RH	VariEco L RH High-speed version	VariEco L NHK
Top	Bottom			
Freely adjustable*	Freely adjustable*	•	•	•

* Mechanical

VariEco L RH

Tubular drives for roller shutters and textile sun protection



Mechanical limit switch, min. shaft size $\varnothing = 63$ mm, round motor head, wrap-around motor head.

Round head RH

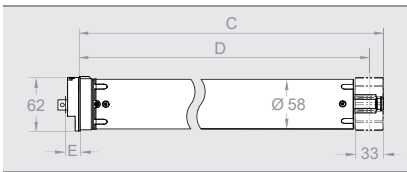

Round head RH	L15/64 RH	L40 RH	L60 RH	L80 RH	L100 RH	L120 RH
Item number	36 883.0101	36 923.0102	36 933.0102	36 943.0101	36 953.0101	36 963.0101

Technical data

Rated torque (Nm)	15	40	60	80	100	120
Rated speed (Upm)	64	14	14	14	11	11
Rated voltage (V)	1 ~ 230	1 ~ 230	1 ~ 230	1 ~ 230	1 ~ 230	1 ~ 230
Rated frequency (Hz)	50	50	50	50	50	50
Rated current (A)	1.8	1.45	1.55	1.8	1.7	2.0
Rated power consumption (W)	415	333	356	415	390	460
Operating time (min. S2)	4	4	4	4	4	4
Length C (mm)	593	563	563	593	593	593
Length D (mm)	575	546	546	576	576	576
Length E (mm)	15	15	15	15	15	15
Weight (kg)	4.8	4.3	4.3	4.3	4.8	4.8

Compatible accessories¹

Item number	Square bolt, 16 x 16 23 375.1501
-------------	-------------------------------------



Accessories such as connection and assembly cables, adapter sets and motor bearings can be found in the section "Accessories for RevoLine L RH / NHK" on page 98.

Suitable control systems can be found in the section "Wall-mounted devices" on page 214.

¹ Depending on application

VariEco L NHK

Tubular drives with emergency crank handle



Mechanical limit switch, min. shaft size $\varnothing = 63$ mm, NHK motor head, emergency manual operation with 7 mm hexagonal shaft.

NHK head

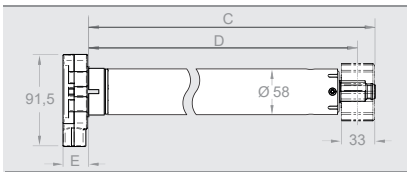

NHK head	L40 NHK	L60 NHK	L80 NHK	L100 NHK	L120 NHK
Item number	36 925.0002	36 935.0002	36 945.0001	36 955.0001	36 965.0001

Technical data

Rated torque (Nm)	40	60	80	100	120
Rated speed (Upm)	14	14	14	11	11
Rated voltage (V)	1 ~ 230	1 ~ 230	1 ~ 230	1 ~ 230	1 ~ 230
Rated frequency (Hz)	50	50	50	50	50
Rated current (A)	1.45	1.55	1.8	1.7	2.0
Rated power consumption (W)	333	356	415	390	460
Operating time (min. S2)	4	4	4	4	4
Length C (mm)	730	730	760	760	760
Length D (mm)	713	713	743	743	743
Length E (mm)	27	27	27	27	27
Weight (kg)	5.8	5.8	6.2	6.2	6.2

Compatible accessories

	Assembly kit (includes 16 x 16 mm motor bolts and adjustment aid)
Item number	23 162.0201



Accessories such as connection and assembly cables, adapter sets and motor bearings can be found in the section "Accessories for RevoLine L RH / NHK" on page 98.

Suitable control systems can be found in the section "Wall-mounted devices" on page 214.

Cables and accessories for Revoline L RH drives



The return of connecting cables is not possible!



23 395.0201

Connection cable without drive, **white**

Item number	Type/Item Description
23 615.2501	0.2 m pluggable
23 395.0201	2.0 m pluggable
23 395.0301	3.0 m pluggable
23 395.0401	5.0 m pluggable
23 395.0501	10.0 m pluggable
23 395.0901	15.0 m pluggable
23 395.0601	20.0 m pluggable
23 395.2601	QuickConnect with MiniPlug, IP 65 Cable length of 0.25 m
23 395.0101	0.4 m, pluggable with Hirschmann plug STAS3, light grey, moulded on
23 395.0801	2.0 m, pluggable with Hirschmann plug STAS3, light grey, screwed on
23 615.2401	0.2 m adapter cable, Type 9 / Revoline



23 395.0101

Connection cable without drive, **black**

Item number	Type/Item Description
23 395.6101	0.5 m pluggable halogen-free
23 395.2201	2.0 m pluggable
23 395.2301	3.0 m pluggable
23 395.9301	3.0 m pluggable halogen-free
23 395.2401	5.0 m pluggable
23 395.9401	5.0 m pluggable halogen-free
23 395.2501	10.0 m pluggable
23 395.9501	10.0 m pluggable halogen-free
23 395.4001	10.0 m pluggable halogen-free with grommet
23 395.2101	0.4 m pluggable with Hirschmann connector STAS3, light grey, moulded on
23 395.8101	0.4 m, pluggable with Hirschmann plug STAS3, light grey, moulded on, halogen-free
23 395.2901	2.0 m, pluggable with Hirschmann plug STAS3, black, screwed on

Assembly and connection cables and accessories

Item number	Type/Item Description
23 395.8502	Assembly cable with 4-pin terminal
13 710.5101	Quick clamp as replacement for assembly cable 23 395.8501
23 285.1201	Cable adapter, 0.25 m, 4-core/STAK3
23 395.2701	QuickConnect, quick connection system, IP 65
23 395.4701	QuickConnect, set of 10
23 846.0001	Hirschmann plug STAS3 (motor side), light grey with clip
13 701.5301	Hirschmann coupling STAK3 (connection side), light grey
23 999.1001	Hirschmann plug STAS3 (motor side), with clip, black
13 703.1001	Hirschmann plug STAK3 (connection side), black
13 308.0001	Flexible adjustment aid



23 395.8502

23 285.1201



13 308.0001

23 395.2701 and 23 395.4701

**Assembly and disassembly must be carried out only in a de-energised state!
The connections to the 230 V mains must be made by authorised specialist personnel.**

Cables and accessories for RevoLine L NHK drives



The return of connecting cables is not possible!

Connection cable without drive, **white**

Item number	Type/Item Description
23 615.0201	2.0 m pluggable
23 615.0301	3.0 m pluggable
23 615.0401	5.0 m pluggable
23 615.0501	10.0 m pluggable
23 615.0601	20.0 m pluggable
23 615.0101	0.4 m pluggable with Hirschmann plug



23 615.0201



23 615.0101



23 395.8502



23 285.1201



23 846.0001

Hirschmann plug, motor side

Item number	Type/Item Description
23 846.0001	STAS3 with clip, light grey
23 999.1001	Hirschmann plug STAS3, black with clip

Cables and accessories

Item number	Type/Item Description
23 395.8502	Assembly cable
13 710.5101	Quick clamp as replacement for assembly cable 23 395.8501
23 285.1201	Cable adapter, 0.25 m, 4-core/STAK3



13 701.5301



13 701.1001

Hirschmann couplings, connection side

Item number	Type/Item Description
13 701.5301	STAK3, light grey
13 703.1001	STAK3, black



13 308.0001



23 395.2701 and 23 395.4701

Cables and accessories

Item number	Type/Item Description
23 395.2701	QuickConnect, quick connection system, IP 65
23 395.4701	QuickConnect, set of 10
13 308.0001	Flexible adjustment aid

**Assembly and disassembly must be carried out only in a de-energised state!
The connections to the 230 V mains must be made by authorised specialist personnel.**

Adapter sets for RH/NHK drives

Profiles of the adapter sets in 1:1 scale can be found from page 266.



Item number	Type/Item Description	Notch tubes	Round tubes	Profile tubes
22 024.0001	Ø 78 x 1.0 mm, MHZ	•		
22 049.0001	Ø 78 x 1.0/1.25 mm, Döhner round	•		
22 055.0001	Ø 78 x 1.25 mm, Round notch Röchling	•		
22 057.0001	Ø 78 x 1.0 mm, Flat notch	•		
22 038.0001	Ø 85 x 1.0 mm	•		
22 023.0001	Ø 90 mm, Le-Profil, Ø 89 mm, Deprat	•		
22 085.0001	Ø 90.5 x 1.25 mm, MHZ	•		
22 097.0001	Ø 101.5 x 1.25 / 102.2 x 1.6 mm, Welser SWS	•		
13 116.9601	Ø 63 x 1.5 mm without thread		•	
22 025.0001	Ø 63 x 1.5 mm with 4 x M6 thread		•	
22 044.0001	Ø 70 x 1.5 mm without thread		•	
22 026.0001	Ø 70 x 1.5 mm with 4 x M6 thread		•	
22 045.0001	Ø 70 x 2.0 mm without thread		•	
22 027.0001	Ø 70 x 2.0 mm with 4 x M6 thread		•	
22 058.0001	Ø 83 x 1.5 mm without thread		•	
22 031.0001	Ø 83 x 1.5 mm with 4 x M6 Gewinde		•	
22 046.0001	Ø 98 x 2.0 mm without thread		•	
22 022.0001	Ø 98 x 2.0 mm with 4 x M6 thread		•	
22 047.0001	Ø 102 x 2.0 mm without thread		•	
22 021.0001	Ø 102 x 2.0 mm with 4 x M6 thread		•	
22 048.0001	Ø 133 x 2.5 mm/Ø 133 x 2 mm without thread		•	
22 036.0001	Ø 133 x 2.5 mm/ Ø 133 x 2.0 mm with 4 x M6 thread		•	
13 117.0901	Ø 67 x 1.5 mm, MHZ			•
22 020.0001	Octagonal, SW 70, Selve, Eckermann, Roma			•
22 029.0001	For hexagonal, Ø 75, Butzbach, Mäule			•
22 033.0001	Ø 76 x 1.2 mm, Kittelberger, Wiral			•
22 032.0001	ZF 80, Zurflüh-Feller			•
22 037.0001	For hexagonal, Ø 85 mm, Butzbach			•
22 035.0001	For Octagonal, SW 102 x 2.0 mm, Alulux			•
22 028.0001	For Octagonal, SW 102 x 2.5 mm, Roma			•
22 030.0001	For Octagonal, SW 114, Heroal			•
22 034.0001	Ø 128 x 1.5 mm, Alukon			•
22 039.0001	Ø 85 x 1.2 mm, Imbac			•
22 043.0001	Ø 85 x 1.2 mm, Griesser			•
13 115.9901	Coupling remover			

MaxiClick rigid shaft connectors



Item number	Type/Item Description
13 309.1001	MaxiClick, 1-membered
13 309.1101	MaxiClick, 2-membered
13 309.1201	MaxiClick, 3-membered
13 309.1401	MaxiClick slide-in profile
13 309.1501	MaxiClick compensation profile

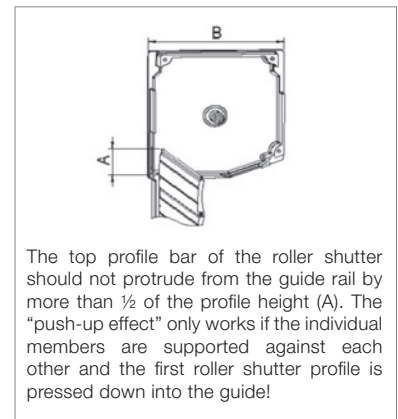

Determination of the suitable MaxiClick shaft connector

Shaft connector	With box depth B ¹ (mm)	Number per blind	Blind weight (kg)	Application range
1-membered	125 – 160	One rigid shaft connector per 60 cm shaft length or 6 Nm motor output.	Max. 12 per shaft connector	Maxi profile ¹
2-membered	160 – 200			
3-membered	200 – 250			

¹ Values depend, among other things, on the shaft type.

Anti push-up devices

Anti push-up devices, standard profile

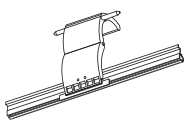

13 301.8801
2-membered
Standard profile

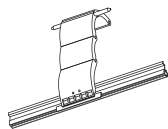

13 301.9001
3-membered
Standard profile

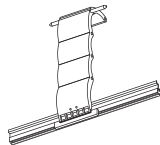

13 301.9201
4-membered
Standard profile

Attachment rings

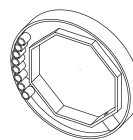

13 301.9601
For 70 mm
Octagonal shaft

16 x 16 mm motor bearing

For RH drives

(in conjunction with square bolt 23 375.1501)



and for NHK drives

(in conjunction with assembly kit set 23 162.0201)

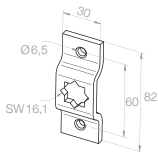

13 106.3501
16 x 16 mm,
Pitch circle of 60 mm,
cranked

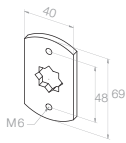

13 103.3901
16 x 16 mm,
Pitch circle of
48 mm, flat

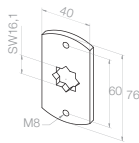

13 103.4001
16 x 16 mm,
Pitch circle of 60 mm,
flat

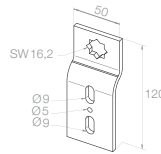

13 301.0801
16 x 16 mm
Star

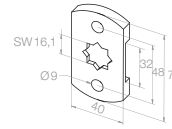

13 110.5601
Spacer plate for
13 103.3901
(cannot be used
as bearing)

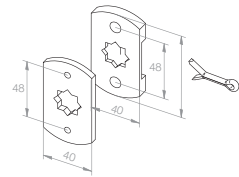

23 109.0001
Motor bearing, flat, 16 x 16 mm,
pitch circle Ø 48 mm with
plastic spacer plate and split pin
(includes no. 13 103.3901 and
13 110.5601)

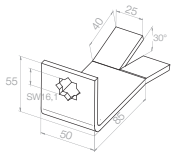

13 300.8501
Plaster motor
bearing,
16 x 16 mm,

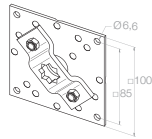

23 833.0001
Base plate
With motor bearing,
pitch circle of 48,
60, 90 mm

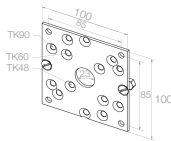

23 687.0501
Base plate with
2 retractable
M6 x 16 screws
and nuts

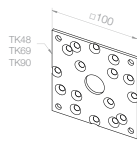

13 109.2902
Adapter plate, pitch
circle of 48, 60, 90 mm,
without motor bearing
and screws

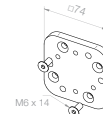

23 687.0401
Aluminium spacer
plate, black, with
2 x M6 x 14 mm
screws

Motor bearing only for NHK drives



Spacer plate

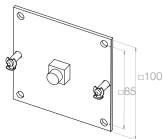

23 800.0001
Motor bearing plate
for NHK motor head

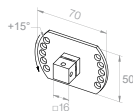

23 687.0201
NHK motor mounting,
16 x 16 mm, for variable
angle in 15° increments

Square bolt for RH head



Pin



23 375.1501
16 x 16 mm RH

SH adapter for RH head



SH-Adapter



23 375.0901
Max. 80 Nm
Compatible with Somfy and Selve bearing
(not compatible with VariEco RH drives)

Motor bearing

For SH drives



and for RH drives

(in conjunction with SH adapter 23 375.0901)



Star motor bearing

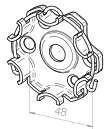

23 003.1701
Motor bearing TK 48 with safety clip (small eyelet), max. 50 Nm

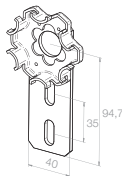

23 003.1801
Motor bearing without safety clip (max. 50 Nm)



13 123.4501
Safety clip with large eyelet

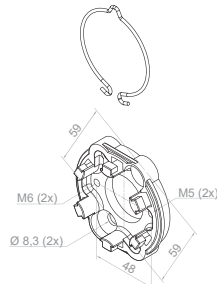

23 617.6001
Awning bearing with safety clip (small eyelet)

Manual override

Hand cranks

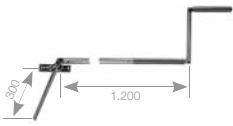

23 764.0002
Hinged crank with joint bearing (45°) and 7 mm hexagonal



23 731.0002
Joint bearing with awning eyelet



23 771.0002
7 mm hexagonal with awning eyelet, 175 mm long



23 771.0102
7 mm hexagonal with awning eyelet, 460 mm long

23 771.0301
7 mm hexagonal with awning eyelet, 600 mm long



12 300.0901
Crank for awning hook Length 1.4 m

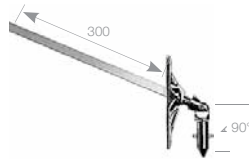

23 772.0002
Joint bearing (45°) for crank with adapter cone

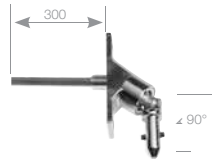

23 342.0001
Joint bearing (90°) for crank with adapter cone

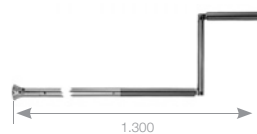

23 773.0001
Hinged crank with adapter cone

NMA adapter set



23 199.5701
Adapter, 7 mm, hex. for M/L NHK Suitable for drive shaft, extensible

NMA basic set



23 081.0001
Drive shaft, extensible 1.70 – 3.00 m

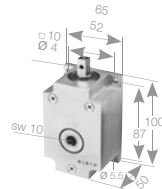

23 030.0001
Angle drive



13 305.8001
Crank handle for angle drive

TA0-RD/X safety brake

For left or right-hand installation, suitable for built-in roller shutters



24 031.0001
TA0-RD/X
Maximum torque of 147 Nm, maximum operating speed of 22 rpm with damping and el. cut-out

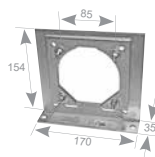

24 040.0001
Pedestal bearing bracket, complete for TA0-RD/X

Adapter TA0-RD/X (always order 2 pieces)



Item number	Type/Item Description	Notch tubes	Round tubes	Profile tubes
13 114.8701	Ø 78 x 1.0 mm/78 x 1.25 mm, Flat notch MHZ	•		
13 117.5301	Ø 78 x 1.0 mm/1.25 mm	•		
13 114.7601	Ø 85 x 1.0 mm	•		
13 117.0501	Ø 90 mm, Le Profil and Ø 89 mm, DEPRAT	•		
13 117.1001	Ø 90.5 x 1.25 mm, MHZ	•		
13 116.9601	Ø 63 x 1.5 mm		•	
13 116.9701	Ø 70 x 1.5 mm		•	
13 117.2801	Ø 70 x 2.0 mm		•	
13 117.7101	Ø 83 x 1.5 mm (with profile)		•	
13 117.0301	Ø 102 x 1.5 mm and Ø 102 x 2.0 mm		•	
13 117.0401	Ø 102 x 3.5 mm and Ø 98 x 2.0 mm		•	
13 117.7901	Ø 133 x 2.5 mm and Ø 133 x 2.0 mm		•	
13 117.0901	Ø 67 x 1.5 mm, MHZ			•
13 115.9301	Octagonal shaft size 70 Selve, Döhner, Eckermann			•
13 117.1101	Hexagonal, 75 mm, Butzbach, Mäule			•
13 116.7601	Ø 76 x 1.2 mm, Kittelberger, Wiral			•
13 114.8501	Ø 80 mm, Zurflüh-Feller			•
13 117.8601	Hexagonal shaft size 80 mm, Butzbach			•
13 117.7701	Octagonal shaft size 102 x 2 mm, Alulux			•
13 117.5101	Octagonal shaft size 102 x 2.5 mm, Roma			•
13 117.5501	Octagonal shaft size 114 mm, Heroal			•
13 117.7401	Ø 128 x 1.5 mm, Alukon			•

elero

**JA Venetian
Blind drives**

JA Comfort /-868	110.
JA Soft	112.
JA e	112.
JA dk	112.
JAR Soft	113.
JAR dk	113.
JA NHK	113.
JA accessories	115.

JA Venetian Blind drives



With their compact dimensions, the venetian blind drives of the JA series are optimally matched to the specific requirements of (outdoor) venetian blinds. The drives are available with mechanical or electronic limit switches, which are also available with an integrated radio system. Special drives, which enable external

emergency manual operation and SMI drives for the highest project requirements and full integration in the building management system, round off the portfolio. Depending on the version, drives from 6 to 20 Nm with 26 to 50 rpm are available. All drives are characterised by simple installation and quick commissioning.

JA venetian blind drives are available in the following versions:

	Drive head
<p>JA Comfort-868 / JA Comfort</p> <ul style="list-style-type: none"> - Drive on both sides - Electronic limit switch - Noiseless soft brake with slow gear - With/without 868 MHz radio control 	
<p>JA Comfort SMI</p> <ul style="list-style-type: none"> - Drive on both sides - Electronic limit switch with positioning - Interface to SMI motor control systems - Noiseless soft brake with slow gear 	
<p>JA Soft / JA dk</p> <ul style="list-style-type: none"> - Drive on both sides - Mechanical limit switch up/down - Noiseless soft brake (JA-Soft) 	
<p>JAR Soft / JAR dk</p> <ul style="list-style-type: none"> - Drive on both sides - Mechanical limit switch up/down1/down2 - Noiseless soft brake (JA-Soft) 	
<p>JA NHK</p> <ul style="list-style-type: none"> - Drive on both sides - Mechanical limit switch - Emergency manual operation with crank 	
<p>JA e</p> <ul style="list-style-type: none"> - Drive on one side - Mechanical limit switch up/down - Capacitor, external 	



Applications	JA Comfort-868 JA Comfort	JA Comfort SMI	JA Soft	JA e	JA dk	JAR Soft	JAR dk	JA NHK
Page	110	111	112	112	112	113	113	114
(Outdoor) venetian blinds	•	•	•	•	•	•	•	•

TOP functions	JA Comfort-868 JA Comfort	JA Comfort SMI	JA Soft	JA e	JA dk	JAR Soft	JAR dk	JA NHK
Feature	Standstill detection and belt length compensation	Standstill detection and belt length compensation	Noiseless soft brake	Capacitor, external		Noiseless soft brake		Emergency manual operation
Electronic limit switch	•	•						
Mechanical limit switch			•	•	•	•	•	•
Additional limit switch AB2						•	•	
Noiseless soft brake	•	•	•			•		
Electromagnetic brake				•	•		•	•
Drive on both sides	•	•	•		•	•	•	•
Drive on one side				•				
Capacitor, external				•				
Freely programmable panel position	•	•						
Slow travel when turning the slats	•	•						

Technical data	JA Comfort-868 JA Comfort	JA Comfort SMI	JA Soft	JA e	JA dk	JAR Soft	JAR dk	JA NHK	
Rated torque (Nm)	4 to 9	4 to 9	6 and 9	6	6 to 20	6 and 9	6 to 20	9	
Rated speed (rpm)	26 to 50	26 to 50	26	26	26	26	26	26	
Rated speed, slow travel (rpm)	6	6	–	–	–	–	–	–	
Length A (mm)	from 243	from 243	from 228	202	from 228	from 273	from 273	328	
Noiseless soft brake	•	•	•	–	–	•	–	–	
Protection class (IP)	54	54	44	44	44	44	44	44	
Limit switch range (rev.)	180	180	85	85	85	85	85	85	
Ambient operating temperature (°C)	-20 to +60	-20 to +60	-20 to +60	-20 to +60	-20 to +60	-20 to +60	-20 to +60	-20 to +60	
Conformity									
Connection cable (m)	0,5 (with Hirschmann plug STAS3 and clip)					0,5 (with Hirschmann plug STAS4 and clip)		0,5 (with Hirschmann plug STAS3 and clip)	

Venetian Blind drives

JA Comfort /-868



JA Comfort /-868 drives are equipped with additional functions which increase both the operating comfort and system characteristics. For example, the drives have a slow speed function to approach an exact lamella angle, standstill detection and belt length compensation. All drives are also available with an integrated radio system. Drives from 4 to 9 Nm with 26 to 50 rpm are available. Installation is easy and commissioning is quick and convenient with the assembly cable.

Yubii® Home¹

JA 06 ..., JA 04/35 ...

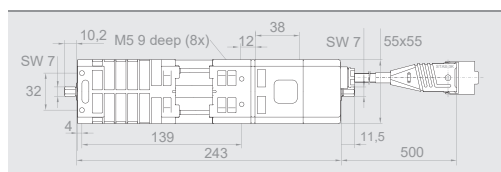

JA 09 ..., JA 06/35 ..., JA 04/50...

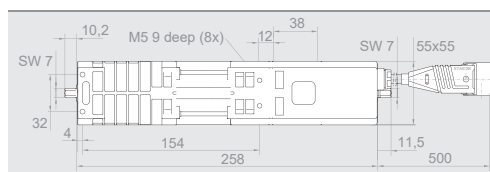

JA Comfort head	JA 06 Comfort-868	JA 09 Comfort-868	JA 04/35 Comfort-868	JA 06/35 Comfort-868	JA 04/50 Comfort-868
Item number	35 222.0003	35 232.0003	35 226.0003	35 236.0003	35 246.0003

JA Comfort head	JA 06 Comfort	JA 09 Comfort	JA 04/35 Comfort	JA 06/35 Comfort	JA 04/50 Comfort
Item number	35 221.0003	35 231.0003	35 225.0003	35 235.0003	35 245.0003

Technical data

	JA 06	JA 09	JA 04/35	JA 06/35	JA 04/50
Rated torque (Nm)	6	9	4	6	4
Rated speed (Upm)	26	26	35	35	50
Rated voltage (V)	1 ~ 230	1 ~ 230	1 ~ 230	1 ~ 230	1 ~ 230
Rated frequency (Hz)	50	50	50	50	50
Noiseless soft brake	•	•	•	•	•
Rated current (A)	0.5	0.68	0.5	0.68	0.68
Rated power consumption (W)	115	156	115	156	156
Operating time (min. S2)	5	4	5	4	4
Length A (mm)	243	258	243	258	258
Weight (kg)	1.60	1.95	1.60	1.95	1.95
Ambient operating temperature (°C)	-20 to +60	-20 to +60	-20 to +60	-20 to +60	-20 to +60

Compatible accessories | Cable routing for JA Comfort

Item no.	16 303.3401
----------	-------------

Safety cut-out, 18 mm, flat (Standard)

Item no.	26 200.8701
----------	-------------

Safety cut-out, 28 mm, flat

Item no.	26 200.8801
----------	-------------

Safety cut-out, 49 mm, flat (extra long)

Item no.	26 200.9101
----------	-------------

Safety cut-out, 60 mm, beveled

Item no.	26 200.9001
----------	-------------

Compatible accessories	Assembly cable (4-pin terminal)
------------------------	---------------------------------

Item number	23 395.8502
-------------	-------------

Compatible accessories	Cable adapter (4-core/STAK3)
------------------------	------------------------------

Item number	23 285.1201
-------------	-------------



Suitable accessories can be found in the section "Accessories for venetian blind drives" on page 115. Suitable control systems and radio transmitters and sensors can be found in the section "Home automations" on page 138.

¹ only 868 variants

Venetian Blind drives

JA Comfort SMI



JA Comfort drives have a slow speed function to approach the exact lamella angle, standstill detection and belt length compensation. Drives from 4 to 9 Nm with 26 to 50 rpm are available. Installation is easy and commissioning is quick and convenient with the SMI assembly cable. SMI drives for the highest project requirements and full integration in the building management system with exact position approach, feedback and much more.

JA 06 ..., JA 04/35 ...

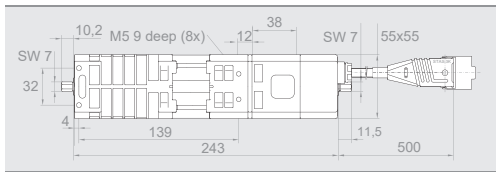

JA 09 ..., JA 06/35 ..., JA 04/50...

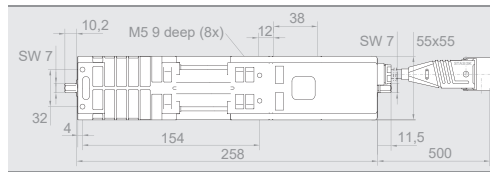

JA Comfort head	JA 06 Comfort SMI	JA 09 Comfort SMI	JA 04/35 Comfort SMI	JA 06/35 Comfort SMI	JA 04/50 Comfort SMI
Item number	35 357.0001	35 367.0001	35 355.0001	35 365.0001	35 325.0001

Technical data

Rated torque (Nm)	6	9	4	6	4
Rated speed (Upm)	26	26	35	35	50
Rated voltage (V)	1 ~ 230	1 ~ 230	1 ~ 230	1 ~ 230	1 ~ 230
Rated frequency (Hz)	50	50	50	50	50
Noiseless soft brake	•	•	•	•	•
Rated current (A)	0.5	0.68	0.5	0.68	0.68
Rated power consumption (W)	115	156	115	156	156
Operating time (min. S2)	5	4	5	4	4
Length A (mm)	243	258	243	258	258
Weight (kg)	1.60	1.95	1.60	1.95	1.95
Ambient operating temperature (°C)	-20 to +60	-20 to +60	-20 to +60	-20 to +60	-20 to +60

Compatible accessories

Compatible accessories	Assembly cable for SMI drives with STAK4
Item number	23 254.0001

Suitable accessories can be found in the section “Accessories for venetian blind drives” on page 115.

Suitable control systems and radio transmitters and sensors can be found in the section “Home automations” on page 138.

Venetian Blind drives JA / JA Soft



Mechanical limit switches, noiseless soft brake in Soft versions, suitable for head rails from 51 (h) x 57 (w) mm.

JA 06 Soft

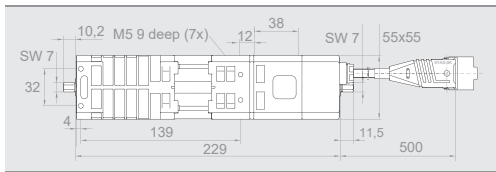

JA 09 Soft

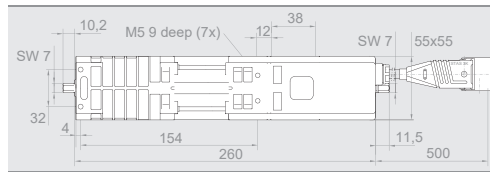

Data sheets on request.

JA head	JA 06 Soft	JA 09 Soft	JA 06e	JA 06dk	JA 10dk	JA 20dk
Item number	35 204.0003	35 224.0003	35 022.0002	35 052.0003	35 062.0003	35 072.0003

Technical data

Rated torque (Nm)	6	9	6	6	10	2 x 10
Rated speed (Upm)	26	26	26	26	26	26
Rated voltage (V)	1 ~ 230	1 ~ 230	1 ~ 230	1 ~ 230	1 ~ 230	1 ~ 230
Rated frequency (Hz)	50	50	50	50	50	50
Noiseless soft brake	•	•	–	–	–	–
Rated current (A)	0.5	0.68	0.5	0.5	0.55	1.,0
Rated power consumption (W)	115	156	115	115	125	230
Operating time (min. S2)	5	4	5	5	5	4
Length A (mm)	229	260	203	229	260	284
Weight (kg)	1.77	1.89	1.53	1.71	1.81	2.20
Ambient operating temperature (°C)	-20 to +60	-20 to +60	-20 to +60	-20 to +60	-20 to +60	-20 to +60

Compatible accessories

Item number	Assembly cable (4-pin terminal)
	23 395.8502



Item number	Cable adapter (4-core/STAK3)
	23 285.1201



Suitable accessories can be found in the section “Accessories for venetian blind drives” on page 115. Suitable control systems and sensors can be found in the section “Wall-mounted devices” on page 214.

Venetian Blind drives JAR / JAR Soft



Mechanical limit switches, downstream auxiliary limit switch, noiseless soft brake in Soft versions, suitable for head rails of min. 51 (h) x 57 (b) mm.

JAR 06 Soft

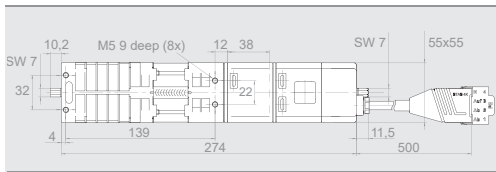

JAR 09 Soft

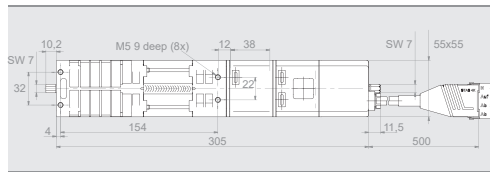

Data sheets on request.

JAR head	JAR 06 Soft	JAR 09 Soft	JAR 06dk	JAR 10dk	JAR 20dk
Item number	35 084.0003	35 094.0003	35 082.0003	35 092.0003	35 102.0003

Technical data					
Rated torque (Nm)	6	9	6	10	2 x 10
Rated speed (Upm)	26	26	26	26	26
Rated voltage (V)	1 ~ 230	1 ~ 230	1 ~ 230	1 ~ 230	1 ~ 230
Rated frequency (Hz)	50	50	50	50	50
Noiseless soft brake	•	•	–	–	–
Rated current (A)	0.5	0.68	0.5	0.55	1.0
Rated power consumption (W)	115	156	115	125	230
Operating time (min. S2)	5	4	5	5	4
Length A (mm)	274	305	274	304	329
Weight (kg)	1.87	1.87	1.69	1.87	2.31
Ambient operating temperature (°C)	-20 to +60	-20 to +60	-20 to +60	-20 to +60	-20 to +60

Compatible accessories	Assembly cable for JAR drives
Item number	26.843.0002

Suitable accessories can be found in the section “Accessories for venetian blind drives” on page 115. Suitable control systems and sensors can be found in the section “Wall-mounted devices” on page 214.

Venetian Blind drives JA NHK



Mechanical limit switches, system can be operated by external crank gear (self-locking) with emergency hand crank, suitable for head rails of min. 51 (h) x 57 (w) mm.

JA 09 NHK in the light

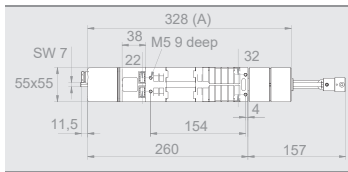

JA 09 NHK out of the light

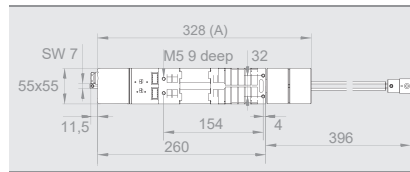

JA NHK head	In the light for 11 mm / hexagonal	Out of the light for 11 mm / hexagonal	In the light for 12 mm / square	Out of the light for 12 mm / square
Item number	35 417.0413	35 418.0413	35 417.2413	35 418.2413

Technical data

Rated torque (Nm)	9	9	9	9
Rated speed (Upm)	26	26	26	26
Rated voltage (V)	1 ~ 230	1 ~ 230	1 ~ 230	1 ~ 230
Rated frequency (Hz)	50	50	50	50
Suitable for	11 mm hexagonal	11 mm hexagonal	12 mm square	12 mm square
Rated current (A)	0.55	0.55	0.55	0.55
Rated power consumption (W)	125	125	125	125
Limit switch range (rpm)	85	85	85	85
Operating time (min. S2)	5	5	5	5
Length A (mm)	328	328	328	328
Weight (Kg)	2.1	2.1	2.1	2.1
Ambient operating temperature (°C)	-20 to +60	-20 to +60	-20 to +60	-20 to +60

Compatible accessories

Item number	23 395.8502	
Item number	23 285.1201	

Suitable accessories can be found in the section "Accessories for venetian blind drives" on page 115. Suitable control systems and sensors can be found in the section "Wall-mounted devices" on page 214.

Accessories for JA drives

Couplings



Single couplings

Item number	Type/Item Description
16 300.3501	Hexagon, 6.0 mm, with 3.3 mm bore
16 300.1301	Hexagon, 8.0 mm, with 3.3 mm bore
16 300.1401	Hexagon, 9.0 mm
16 300.8901	Square, 6.0 mm, with 3.3 mm bore
16 300.1001	Square, 8.0 mm, with 3.3 mm bore
16 300.1101	Square, 9.0 mm, with 3.3 mm bore
16 300.1501	Notch tube, Ø 12.0 mm, with 3.3 mm bore

Single couplings – (required for KITS)

Item number	Type/Item Description
26 500.1301	Notch tube, 14 mm, long, with M5 x 6 pan-head screw, ISO7380-1, Poly Fleck, thread on both sides
26 526.0002	Square, 12.0 mm, long, with M5 x 16 grub screw, DIN 916
26 504.0002	Square, 12.0 mm, long, with M5 x 5 grub screw, DIN 916
26 500.1202	Notch tube, 14 mm, long, with M5 x 8 grub screw, DIN 916, Poly-Fleck
26 500.0002	Notch tube, 14 mm, long, with M5 x 8 grub screw, DIN 916



Coupling set

– 2 couplings; 2 self-tapping screws;
2 matching grub screws, self-locking

Item number	Type/Item Description
26 512.1001	Hexagonal, 9.0 mm, with M5 thread
26 506.1001	Hexagonal, 13.0 mm, with M5 thread

Coupling set

– 2 couplings; short design; no continuous bore; no thread;
2 self-tapping screws; 2 matching grub screws, self-locking

Item number	Type/Item Description
26 517.0001	Square, 6.0 mm, with 3.3 mm bore



QuickSnap single couplings

Item number	Type/Item Description
16 300.1202	Hexagon, 7.0 mm, short, with 3.3 mm bore
16 300.8502	Square, 7.0 mm, short with M4 thread
16 300.2402	Square, 10.0 mm, short, with 3.3 mm bore
16 300.0702	Square, 12.0 mm, short, with 3.3 mm bore
16 300.1602	Notch tube, Ø 14.0 mm, short, with 3.3 mm bore

QuickSnap coupling set

– 2 couplings; 2 matching grub screws, self-locking

Item number	Type/Item Description
26 514.0002	Hexagonal, 11.0 mm, with M5 thread
26 522.0002	Square, 7.0 mm, short, with M5 thread
26 513.1002	Square, 10.0 mm, long, with M5 thread
26 504.1002	Square, 12.0 mm, long with M5 thread
26 500.1002	Notch tube, 14.0 mm, long, with M5 thread

Accessories for JA drives

Installation accessories, electric



Extension cable with Hirschmann coupling STAK3 (no. 13 701.5301) connected at one end, other cable end not assembled

Item number	Type/Item Description
26 618.0201	2.50 m
26 618.0501	5.00 m
26 618.0601	6.00 m
26 618.1001	10.00 m
26 618.3501	15.00 m



Extension cable with Hirschmann coupling STAK 3 (no. 13 701.5301) and Hirschmann plug STAS3 (no. 23 846.0001)

Item number	Type/Item Description
26 617.0101	1.25 m
26 617.0201	2.50 m

Delivery time by arrangement!



Extension cable with Hirschmann coupling STAK3 (no. 13 701.5301) connected at one end and cable end stripped 40 mm on one side. Fit stranded wires with wire end ferrules

Item number	Type/Item Description
26 618.2201	2.20 m halogen-free
26 618.1501	5.00 m
26 618.0901	9.20 m
26 618.2001	10.00 m



23 846.0001



13 708.6601

Hirschmann plug, motor side

Item number	Type/Item Description
23 846.0001	STAS3 with clip, light grey
23 999.1001	Hirschmann plug STAS3, black with clip
13 708.6601	STAS4 for JAR or JA SMI drives
16 702.0101	STAS4 safety bracket



23 395.8502



23 285.1201

Assembly cable

Item number	Type/Item Description
23 395.8502	Assembly cable, 4-pin
13 710.5101	Fast clamp as replacement for assembly cable 23 395.8501
23 285.1201	Cable adapter, 0.25 m, 4-core / STAK3
26.843.0002	For JAR drives with Hirschmann coupling STAK4
23 254.0001	Assembly cable for SMI drives with STAK4



13 701.5301



13 703.1001



13 704.9801

Hirschmann couplings, connection side

Item number	Type/Item Description
13 701.5301	STAK3, light grey
13 703.1001	STAK3, black
13 704.9801	STAK4 for JAR or JA SMI drives

Item number	Type/Item Description
23 375.6001	Wire jumper for Hirschmann plug for radio motors



16 101.0102



13 707.5701

Item number	Type/Item Description
16 101.0102	Cable sleeve for plug leading
13 707.5701	Clip for cable sleeve in head rail
13 308.4201	Rubber grommet
16 103.0901	Clip-on cable protection for JA Comfort motor

Accessories for JA drives

Installation accessories, mechanical

Screwless fixing – JA venetian blind clip sets

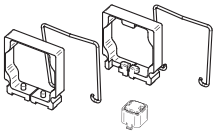

26 611.0001

For 68 x 66 mm head rail;
35.0 mm shaft height, black
(Griesser)

Set includes:

- 2 x 16 300.8802 clamping bracket
- 1 x 16 300.8602 rubber damper (motor centre)
- 1 x 16 300.8701 rubber damper (gear side)
- 1 x 26 200.3601 orange safety cut-out
(for Soft & dk motors)

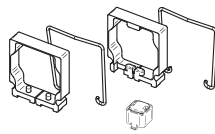

26 612.0001

For 58 x 56 mm head rail;
29.0 mm shaft height, grey

Set includes:

- 2 x 16 302.2001 clamping bracket
- 1 x 16 302.2102 rubber damper (motor centre)
- 1 x 16 302.2201 rubber damper (gear side)
- 1 x 26 200.3601 orange safety cut-out
(for Soft & dk motors)

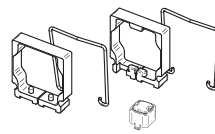

26 613.0002

Set of 10 for head rail
58 x 56 mm;
29.0 mm shaft height

1 set includes:

- 2 x 16 302.2001 clamping bracket
- 1 x 16 302.2102 rubber damper (motor centre)
- 1 x 16 302.2201 rubber damper (gear side)
- 1 x 26 200.3601 orange safety cut-out
(for Soft & dk motors)

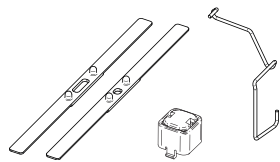

26 529.0001

For 57 x 51 mm head rail;
29.5 mm shaft height

Set includes:

- 2 x 16 302.3201 clamping bracket
- 1 x 16 103.1801 rubber damper (motor centre)
- 1 x 16 103.1901 rubber damper (gear side)
- 1 x 26 200.3601 orange safety cut-out
(for Soft & dk motors)

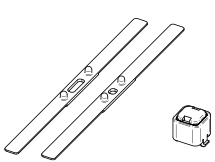

26 528.0001

Head rail, 57 x 51 mm;
29.5 mm shaft height

Set includes:

- 1 x 16 103.1801 rubber damper
- 1 x 16 103.1901 rubber damper
- 1 x 26 200.3601 safety cut-out

Assembly kit JA complete

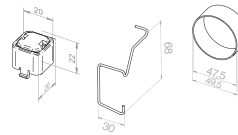

26 527.0001

consisting of:

- 2 x clamping bracket wire,
- 2 x hose piece,
- 1 x safety cut-out orange

JA/JAR assembly kit with 2 dampers, 4 screws, safety cut-out, right (orange) and assembly instructions

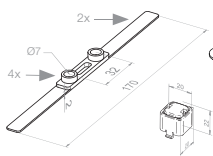

26 520.0002

for 29.5 mm shaft height

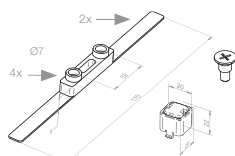

26 521.0002

for 35.5 mm shaft height
(Faber)

Drilling template

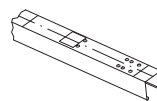

16 801.7001

Drilling template

Clamping bracket

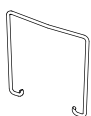

16 300.8802

Clamping bracket for
Griesser damper
(2 required)



16 302.3201

Internal clamping, for
57 x 51 mm head rail;
(2 required)



13 309.3901

Clamping bracket for
Schenker Storen
channel, 80 x 55 mm
(only 1 required)

Screws



16 300.7302

Screws for 2.0 mm
damper height



16 300.7402

Screws for 8.0 mm
damper height

Accessories for JA drives

Installation accessories, mechanical

Damper (Griesser)

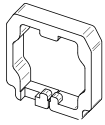

16 302.4601
Damper for Griesser channel, 68 x 66 mm, soft (grey) (gear side)

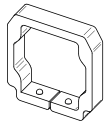

16 302.4502
Damper for Griesser channel, 68 x 66 mm, soft (grey) (motor centre)

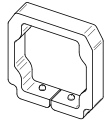

16 300.8701
Damper for Griesser channel, 68 x 66 mm, hard (black) (gear side)

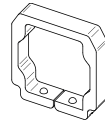

16 300.8602
Damper for Griesser channel, 68 x 66 mm, hard (black) (motor centre)

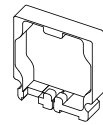

16 302.2201
Rubber damper for 58 x 56 mm head rail (gear side)

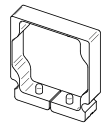

16 302.2102
Rubber damper for 58 x 56 mm head rail (motor centre)

Damper with fixing knobs



16 103.1801
Height: 2.0 mm
Stud spacing: 32.0 mm (Gear side)

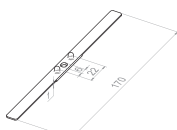

16 103.1901
Height: 2.0 mm
Stud spacing: 22.0 mm (Motor centre with 2 holes)

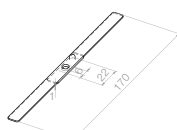

16 104.0801
Height: 2.0 mm
Stud spacing: 22.0 mm (motor centre with 1 hole)

Hose piece



16 302.8301
Damper belt for venetian blind drive, 2 pieces are required per drive

Damper

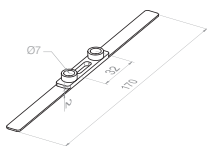

16 101.6001
Height: 2.0 mm
Hole spacing: 32.0 mm (Gear side)

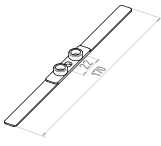

16 101.6101
Height: 2.0 mm
Hole spacing: 22.0 mm (motor centre)

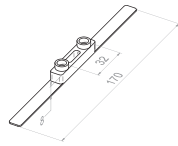

16 101.6201
Height: 8.0 mm
Hole spacing: 32.0 mm (Gear side)

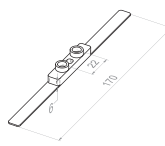

16 101.6301
Height: 8.0 mm
Hole spacing: 22.0 mm (motor centre)

Damper (Schenker Storen)

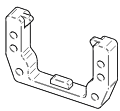

16 300.3001
Damper for Schenker Storen channel, 80 x 55 mm (gear side)

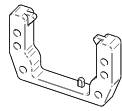

16 300.8301
Damper for Schenker Storen channel, 80 x 55 mm (motor centre)

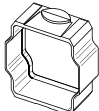

16 307.0002
Warema damper (gear side)

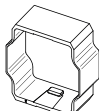

16 307.0102
Damper (Warema) (motor centre)

Damper (Wick)

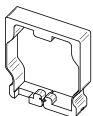

16 302.8101
Wick damper (gear side)

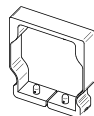

16 302.8202
Wick damper (motor centre)

Accessories for JA drives

Safety cut-outs

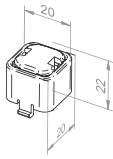

26 200.3601
Safety cut-out, right (orange)



26 200.3701
Safety cut-out, right (orange), extended

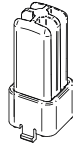

26 200.8101
Extended safety cut-out, 49 mm, right (orange limit switch), black

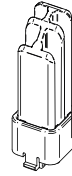

26 200.8001
Bevelled, extended safety cut-out, 60 mm, right (orange limit switch), black

Safety cut-outs



16 701.4701
Bevelled safety cut-out attachment, black.
Fits on:
16 101.4501 (1x or 3x),
16 101.4601 (1x)

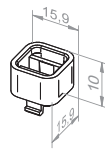

16 101.4502
Safety cut-out extension à 10.0 mm, max. 3x on top of each other

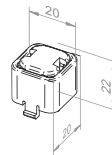

26 200.1101
Safety cut-out, left (white)

Accessories for JA Comfort drives

Damper for JA Comfort

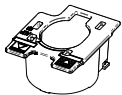

16 303.3401
Cable router / protection for JA Comfort drives



26 200.8701
Safety cut-out, 18 mm, flat (standard)



26 200.8801
Safety cut-out, 28 mm, flat

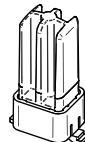

26 200.9101
Safety cut-out, 49 mm, flat (extra long)

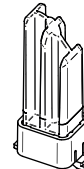

26 200.9001
Safety cut-out, 60 mm, bevelled

elero

Speciality drives

Folding shutter drive

123.

Speciality drives

Venetian Blind drives

RevoLine
L RH / L NHK

RevoLine
S + M

Contemporary lifestyle

When renovating old buildings while keeping with their style, in listed buildings and also in new buildings, people often like to opt for the traditional solution combined with modern technology – the electrically driven folding shutter. The folding shutter drive from elero has an electronic limit switch that is adjusted to the respective torque requirement during commissioning. In this way, the folding shutter is always moved safely and gently into the respective end position and, thanks to sophisticated technology, disturbing rattling is prevented. This results in a long service life for the folding shutter, the mechanism and the drive.



Folding shutter drive

With electronic, adjustable cut-out



Electronic limit switch, obstacle detection, torque adjustment during commissioning, suitable for "Kini" gear (flush-mounted or partially surface-mounted, 230 V/50 Hz, torque up to 20 Nm, short period operation: 4 min).

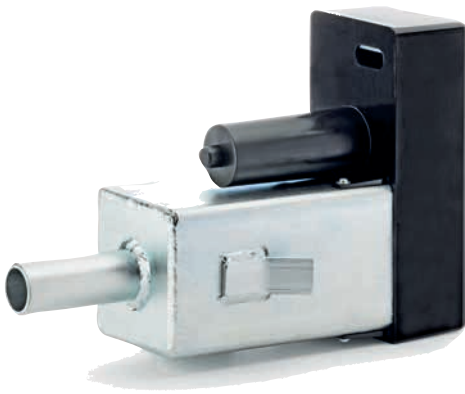

	Folding shutter drive
Item number	35 741.0002

Technical data	
Rated torque (Nm)	20
Rated speed (Upm)	26
Rated voltage (V)	1 ~ 230
Rated current (A)	0.7
Rated power consumption (W)	160
Operating time (min S2)	4
Protection class (IP)	20
Weight (kg)	3.9
Ambient operating temperature (°C)	-20 to +60
Standard scope of delivery	Incl. cleaning cover; note: The inside opener is not included in the scope of delivery!

Compatible accessories	Suitable inside opener gearbox available from:
Kini Beschläge GmbH Mettmannstr. 10 A 42551 Velbert Germany	Phone: +49 2051 8089801 Fax: +49 2051 8089803 E-Mail: info@kini.de Internet: www.kini.de

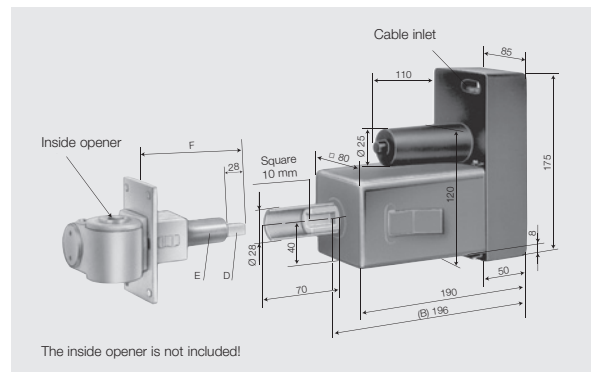

Sample calculation
The drive is to be installed in a wall with a total thickness of 300 mm. Dimension "B" (196 mm) on the folding shutter drive cannot be changed.

Mounting dimensions
As a result of different wall thicknesses, both the square drive shaft of the inside opener and the protective sheath must be adjusted to match the wall concerned during mounting. The following calculation formula can be used here:
Dimension F of inside opener = total wall thickness – 196 mm (B)

Important:
The minimum dimension for flush-mounted installation is 300 mm. For partial surface mounting, 205 - 300 mm.

Accessories and components

	VarioTec-868 Page 194		AstroTec Page 216
--	--------------------------	--	----------------------

elero

**Solar
drive systems**

RoISolar M-868 DC Bundles	128.
RoISolar/D+ M-868 DC Bundles	129.
RoISolar M-868 DC	130.
RoISolar/D+ M-868 DC	131.
RoISolar control systems and accessories	132.
VariEco M DC	136.
SunTop L DC	136.
JA Soft DC	136.
DC control systems and accessories	137.

RoSolar-868 DC



The drive system is powered by solar energy and thus represents a particularly sustainable solution for the automation of privacy and sun protection. RoSolar-868 DC drives are independently supplied with energy by a battery and a solar panel.

Therefore, the system is ideal for the subsequent motorisation of roller shutters and blinds. It is controlled by radio transmitters or via the CenteroHome NXT app with a smartphone or tablet. Predefined bundles are available for many applications.

RoSolar bundles are available with the following drive heads:

elero head

- Small deduction dimension
- Suitable for all RevoLine motor bearings from elero

Funk



RH head (round head)

- Tubular drive with wrap-around round motor head
- Very small deduction dimension
- Individually deployable



SH head (star head)

- Tubular drive with star motor head
- Suitable for common star motor bearings



Bidirectional routing with ProLine 2



ProLine 2, the bidirectional radio system from elero, is more reliable, powerful and transparent than unidirectional radio standards. At the heart of the technology (868 MHz) are bidirectional radio components

(transceivers) that are capable not only of receiving, but also of confirming and relaying the signals. As soon as a command has been executed on the drive, the user receives feedback and can be sure that the commands are being executed correctly.



Applications	RoISolar M-868 DC	RoISolar/D+ M-868 DC
Page	130	131
Roller shutters	•	•
Roller blinds	•	–

TOP functions	RoISolar M-868 DC	RoISolar/D+ M-868 DC
Mechatronic end position detection with soft cut-out	•	•
Intelligent force measurement	•	•
Upward/downward blind protection	•	•
Independent drive system (no wiring to mains necessary)	•	•
Bidirectional radio control (without routing function)	•	•
End positions can be adjusted using the radio transmitter	•	•
Self-learning end positions with release function at top		•
Only in conjunction with rigid shaft connectors		•

Technical data	RoISolar M-868 DC	RoISolar/D+ M-868 DC
Rated torque (Nm)	10 to 20	10 to 20
Rated speed (rpm)	16	16
Min. shaft diameter (mm)	50	50
Diameter (mm)	45	45
Length (mm)	from 478	from 478
Protection class (IP)	44	44
Limit switch range (rev.)	40	40
Noiseless soft brake	•	•
Ambient operating temperature (°C)	-20 to +60	-20 to +60
Conformity	CE	CE
Plug-in connection cable, 0.27 m	•	•

End position programming		RoISolar M-868 DC	RoISolar/D+ M-868 DC
Top	Bottom		
To stop	Freely adjustable	•	
Freely adjustable	To stop	•	
To stop	To stop	•	• <i>Self-learning end positions</i>
Freely adjustable	Freely adjustable	•	

RoSolar

Drive bundles

Roller shutters and blinds

You can choose between different types of drives as well as solar panels and batteries in different designs. This way, you acquire a solution that is tailored to the conditions on site.



works with
Yubii® Home

elero head – radio control

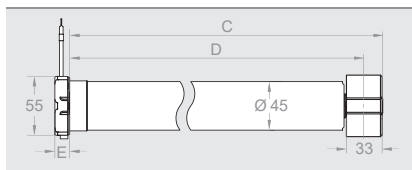

Round head RH – radio control

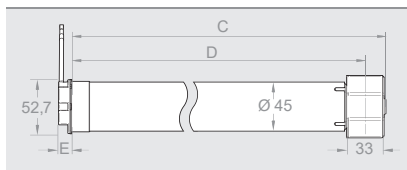

Star head SH – radio control

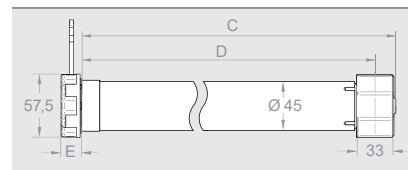

elero head	M10-868 DC Bundle 1	M20-868 DC Bundle 1	M10-868 DC Bundle 2	M20-868 DC Bundle 2	M10-868 DC Bundle 3	M20-868 DC Bundle 3	M10-868 DC Bundle 4	M20-868 DC Bundle 4
Item number	34 220.0001-01	34 230.0001-01	34 220.0001-02	34 230.0001-02	34 220.0001-03	34 230.0001-03	34 220.0001-04	34 230.0001-04
Round head	M10-868 DC RH Bundle 1	M20-868 DC RH Bundle 1	M10-868 DC RH Bundle 2	M20-868 DC RH Bundle 2	M10-868 DC RH Bundle 3	M20-868 DC RH Bundle 3	M10-868 DC RH Bundle 4	M20-868 DC RH Bundle 4
Item number	38 220.0001-01	38 230.0001-01	38 220.0001-02	38 230.0001-02	38 220.0001-03	38 230.0001-03	38 220.0001-04	38 230.0001-04
Star head	M10-868 DC SH Bundle 1	M20-868 DC SH Bundle 1	M10-868 DC SH Bundle 2	M20-868 DC SH Bundle 2	M10-868 DC SH Bundle 3	M20-868 DC SH Bundle 3	M10-868 DC SH Bundle 4	M20-868 DC SH Bundle 4
Item number	39 220.0001-01	39 230.0001-01	39 220.0001-02	39 230.0001-02	39 220.0001-03	39 230.0001-03	39 220.0001-04	39 230.0001-04

Accessories included in the bundle

Connection cable	•	•	•	•	•	•	•	•
Solar panel with 2 mounting holes	•	•	•	•				
Solar panel with adhesive strip					•	•	•	•
Short battery, incl. 2 retaining clips	•	•			•	•		
Battery, long			•	•			•	•

Technical data

Rated torque (Nm)	10	20	10	20	10	20	10	20
Rated speed (rpm)	16	16	16	16	16	16	16	16
Rated voltage (V DC)	12	12	12	12	12	12	12	12
Noiseless soft brake	•	•	•	•	•	•	•	•
Rated current (A)	4.0	6.0	4.0	6.0	4.0	6.0	4.0	6.0
Rated power consumption (W)	48	72	48	72	48	72	48	72
Operating time (min S2)	10	10	10	10	10	10	10	10
Length C (mm)	466	491	466	491	466	491	466	491
Length D (mm)	449	474	449	474	449	474	449	474
Length E (mm)	elero head = 14, round head = 12, star head = 19							
Weight (kg)	1.7	2.2	1.7	2.2	1.7	2.2	1.7	2.2
Ambient operating temp.(°C)	-20 to +60	-20 to +60	-20 to +60	-20 to +60	-20 to +60	-20 to +60	-20 to +60	-20 to +60

Suitable adapter sets and motor bearings can be found in the section "RevoLine M accessories" on page 72.

Further accessories such as additional battery packs, Y-cables and solar panels can be found in the section "RoSolar accessories" on page 132.

You can find suitable control systems and radio transmitters also on the following pages.

RoSolar /D+

Drive bundles

Only in conjunction with rigid shaft connectors!

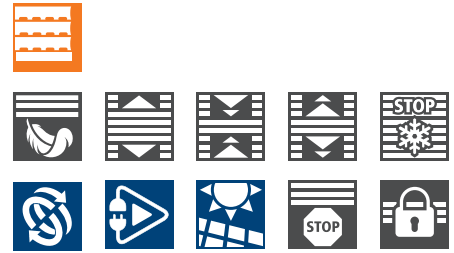

Roller shutters

You can choose between different types of drives as well as solar panels and batteries in different designs. This way, you acquire a solution that is tailored to the conditions on site.

works with
Yubii Home

elero head – radio control

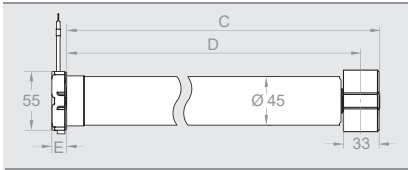

Round head RH – radio control

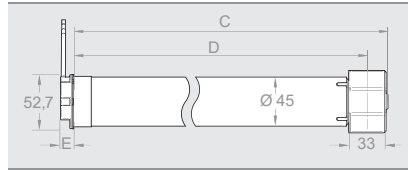

Star head SH – radio control

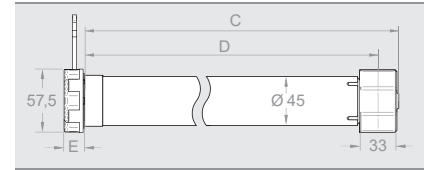

elero head	/D+ M10-868 DC Bundle 1	/D+ M20-868 DC Bundle 1	/D+ M10-868 DC Bundle 2	/D+ M20-868 DC Bundle 2	/D+ M10-868 DC Bundle 3	/D+ M20-868 DC Bundle 3	/D+ M10-868 DC Bundle 4	/D+ M20-868 DC Bundle 4
Item number	34 320.0001-01	34 330.0001-01	34 320.0001-02	34 330.0001-02	34 320.0001-03	34 330.0001-03	34 320.0001-04	34 330.0001-04
Round head	/D+ M10-868 DC RH Bundle 1	/D+ M20-868 DC RH Bundle 1	/D+ M10-868 DC RH Bundle 2	/D+ M20-868 DC RH Bundle 2	/D+ M10-868 DC RH Bundle 3	/D+ M20-868 DC RH Bundle 3	/D+ M10-868 DC RH Bundle 4	/D+ M20-868 DC RH Bundle 4
Item number	38 320.0001-01	38 330.0001-01	38 320.0001-02	38 330.0001-02	38 320.0001-03	38 330.0001-03	38 320.0001-04	38 330.0001-04
Star head	/D+ M10-868 DC SH Bundle 1	/D+ M20-868 DC SH Bundle 1	/D+ M10-868 DC SH Bundle 2	/D+ M20-868 DC SH Bundle 2	/D+ M10-868 DC SH Bundle 3	/D+ M20-868 DC SH Bundle 3	/D+ M10-868 DC SH Bundle 4	/D+ M20-868 DC SH Bundle 4
Item number	39 320.0001-01	39 330.0001-01	39 320.0001-02	39 330.0001-02	39 320.0001-03	39 330.0001-03	39 320.0001-04	39 330.0001-04

Accessories included in the bundle

Connection cable	•	•	•	•	•	•	•	•
Solar panel with 2 mounting holes	•	•	•	•				
Solar panel with adhesive strip					•	•	•	•
Short battery, incl. 2 retaining clips	•	•			•	•		
Battery, long			•	•			•	•

Technical data

Rated torque (Nm)	10	20	10	20	10	20	10	20
Rated speed (rpm)	16	16	16	16	16	16	16	16
Rated voltage (V DC)	12	12	12	12	12	12	12	12
Noiseless soft brake	•	•	•	•	•	•	•	•
Rated current (A)	4.0	6.0	4.0	6.0	4.0	6.0	4.0	6.0
Rated power consumption (W)	48	72	48	72	48	72	48	72
Operating time (min S2)	10	10	10	10	10	10	10	10
Length C (mm)	466	491	466	491	466	491	466	491
Length D (mm)	449	474	449	474	449	474	449	474
Length E (mm)	elero head = 14, round head = 12, star head = 19							
Weight (kg)	1.7	2.2	1.7	2.2	1.7	2.2	1.7	2.2
Ambient operating temp.(°C)	-20 to +60	-20 to +60	-20 to +60	-20 to +60	-20 to +60	-20 to +60	-20 to +60	-20 to +60

Suitable adapter sets and motor bearings can be found in the section "RevoLine M accessories" on page 72.

Further accessories such as additional battery packs, Y-cables and solar panels can be found in the section "RoSolar accessories" on page 132.

You can find suitable control systems and radio transmitters also on the following pages.

RoSolar

Drives

Roller shutters and blinds

Individual motors for replacement purposes or, when put together outside bundles, for even more individuality. Mechatronic end position detection with soft cut-out, intelligent force measurement, upward/downward blind protection and with automatic free travel, activatable release at end position, end positions adjustable by radio control, min. shaft size $\varnothing = 50$ mm, noiseless soft brake, bidirectional radio control at 868 MHz with feedback (without routing).



elero head – radio control

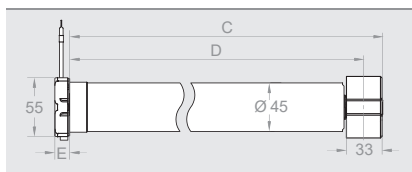

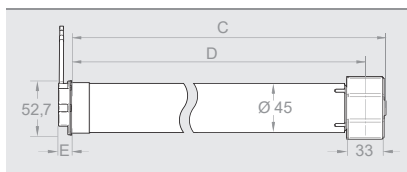

Round head RH – radio control

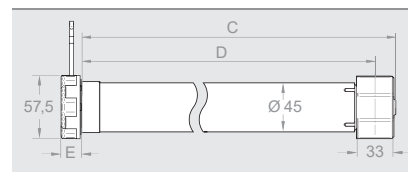

Star head SH – radio control



elero head				M10-868 DC	M20-868 DC
Item number				34 220.0001	34 230.0001
Round head		M1.5/90-868 DC RH	M3/60-868 DC RH	M10-868 DC RH	M20-868 DC RH
Item number		38 360.0001	38 370.0001	38 220.0001	38 230.0001
Star head				M10-868 DC SH	M20-868 DC SH
Item number				39 220.0001	39 230.0001

Technical data

Rated torque (Nm)	1.5	3	10	20
Rated speed (rpm)	90	60	16	16
Rated voltage (V DC)	12	12	12	12
Noiseless soft brake	–	–	•	•
Rated current (A)	4.0	4.5	4.0	6.0
Rated power consumption (W)	48	54	48	72
Operating time (min S2)	10	10	10	10
Length C (mm)	466	491	466	491
Length D (mm)	449	474	449	474
Length E (mm)	elero head = 14, round head = 12, star head = 19			
Weight (kg)	1.7	1.7	1.7	2.2
Ambient operating temperatur (°C)	-20 to +60	-20 to +60	-20 to +60	-20 to +60

Suitable adapter sets and motor bearings can be found in the section “RevoLine M accessories” on page 72.

Further accessories such as additional battery packs, Y-cables and solar panels can be found in the section “RoSolar accessories” on page 132.

You can find suitable control systems and radio transmitters also on the following pages.

RoSolar /D+

Drives

Only in conjunction with rigid shaft connectors!



Roller shutters

Individual motors for replacement purposes or, when put together outside bundles, for even more individuality. Mechatronic end position detection with soft cut-out, intelligent force measurement, upward/downward blind protection and automatic free travel, self-learning end positions with automatic release function, min. shaft size $\varnothing = 50$ mm, noiseless soft brake, bidirectional radio control at 868 MHz with feedback (without routing).

elero head – radio control

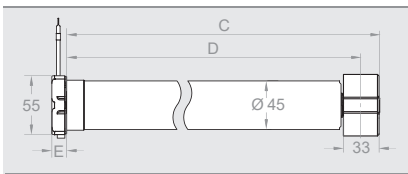

Round head RH – radio control

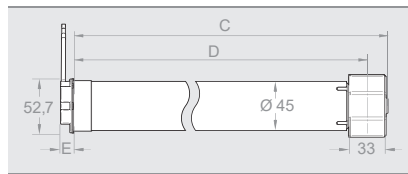

Star head SH – radio control

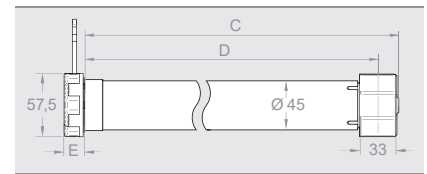

elero head 	/D+ M10-868 DC	/D+ M20-868 DC
Item number	34 320.0001	34 330.0001
Round head 	/D+ M10-868 DC RH	/D+ M20-868 DC RH
Item number	38 320.0001	38 330.0001
Star head 	/D+ M10-868 DC SH	/D+ M20-868 DC SH
Item number	39 320.0001	39 330.0001

Technical data

Rated torque (Nm)	10	20
Rated speed (rpm)	16	16
Rated voltage (V DC)	12	12
Noiseless soft brake	•	•
Rated current (A)	4.0	6.0
Rated power consumption (W)	48	72
Operating time (min S2)	10	10
Length C (mm)	466	491
Length D (mm)	449	474
Length E (mm)	elero head = 14, round head = 12, star head = 19	
Weight (kg)	1.7	2.2
Ambient operating temperature (°C)	-20 to +60	-20 to +60

Suitable adapter sets and motor bearings can be found in the section “RevoLine M accessories” on page 72. Further accessories such as additional battery packs, Y-cables and solar panels can be found in the section “RoSolar accessories” on page 132. You can find suitable control systems and radio transmitters also on the following pages.

RoSolar

Control systems and accessories



A radio transmitter is required for each RoSolar bundle and is not included in the scope of delivery. The following transmitters are available for selection:

MonoCom



- Single-channel handheld transmitter

VarioCom



- 6-channel handheld transmitter
- Manual/automatic operation switchover

MonoTec-868



- Single-channel wall transmitter
- Transmit indicator LED

QuinTec-868



- 5-channel wall transmitter
- Manual/automatic operation switchover

	MonoCom	VarioCom
Item number	28 405.0002	28 445.0002

	MonoTec-868	QuinTec-868
Item number	28 650.0002	28 655.0002

Technical data

	MonoCom	VarioCom
Rated voltage (V DC)	3	3
Battery type	2 x Micro LR03 (AAA)	2 x Micro LR03 (AAA)
Protection class (IP)	20	20
Ambient operating temperature (°C)	0 to +50	0 to +50
Individual channels	1	6
Channels can be combined in groups	-	•
Central channel	-	-
Bidirectional radio control (868 Mhz)	•	•
Dimensions L x W x H (mm)	151 x 49 x 14	151 x 49 x 14
Standard scope of delivery	Incl. wall bracket, mounting set, 2 batteries	







	MonoTec-868	QuinTec-868
Rated voltage (V DC)	3	3
Battery type	3 V Battery CR 2032	3 V Battery CR 2032
Protection class (IP)	20	20
Ambient operating temperature (°C)	0 to +50	0 to +50
Individual channels	1	5
Channels can be combined in groups	-	-
Central channel	-	1
Bidirectional radio control (868 Mhz)	•	•
Dimensions L x W x H (mm)	50 x 50 x 9.6	50 x 50 x 9.6
Standard scope of delivery	Incl. mounting set and battery	



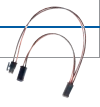

RoISolar

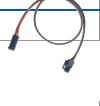
Control systems and accessories

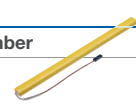
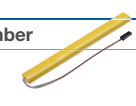

Each RoISolar drive system can also be retrofitted with an additional battery and/or solar panel with a Y-cable (if the battery or solar radiation proves insufficient). A mains unit can also charge the batteries on dark winter days.

Compatible accessories	Solar panel with 2 mounting holes¹
Item number	13 124.7003
	
Compatible accessories	Solar panel with adhesive strip¹
Item number	13 125.1903
	
Compatible accessories	Y-cable Type A
Item number	13 710.6801
	
Compatible accessories	Y-cable Type B
Item number	13 710.6901
	
Compatible accessories	Short extension cable (450 mm)
Item number	23 618.2001
	
Compatible accessories	Long extension cable (1,200 mm)
Item number	23 618.2101
	

Compatible accessories	Connection cable
Item number	23 395.6301
	
Compatible accessories	Long battery²
Item number	13 710.3802
	
Compatible accessories	Short battery²
Item number	13 710.4802
	
Compatible accessories	Retaining clip for short battery
Item number	16 307.1001
	
Compatible accessories	Battery charger³
Item number	13 710.6701
	
Compatible accessories	Spacer for solar panel with 2 mounting holes
Item number	13 125.1201
	

Technical data

Solar panel	
Dimensions of solar panel with 2 mounting holes (mm)	470 × 60
Dimensions of solar panel with adhesive strip (mm)	455 × 60
Solar panel (peak) power (W)	4.2
Protection class (IP code) of solar panel	64
Battery pack	
Type battery pack	NiMH
Dimensions of short battery pack, without cable (mm)	250 × 29.5 × 15
Dimensions of long battery pack, without cable (mm)	500 × 16 × 16
Dimensions of retaining clip for short battery (mm)	24.1 × 28.1 × 15
Charging current (mA)	230
Discharge current (recommended) (mA)	210 to 4.000 (at 20 °C)
Rated voltage, battery pack (V)	12.0
Capacity, battery pack (Ah)	2.1
Nominal charge (Wh), battery pack	25.8
Protection class (IP code) of battery pack	X4
Protection class	III
Cable	
Connection cable length (mm)	270
Length of Y-cable A (mm)	300 / 200
Length of Y-cable B (mm)	300 / 200
Length of short extension cable (mm)	450
Length of long extension cable (mm)	1,200
Battery charger	
Cable length (m)	1.80

¹ A Y-cable of type A is required to connect the solar panel to the existing solar panel.

² A Y-cable of type B is required to connect the battery to the existing battery.

³ A Y-cable of type A is required to use the battery charger.

Solar drive systems



The energy unit, consisting of a solar panel and battery as well as a wide range of drives and control components, enables use in roller shutters, textile sun protection systems and (outdoor) venetian blinds.

And this exclusively with solarenergy!
Operation is convenient via a radio transmitter based on the unidirectional elero radio system with 868 MHz.

The following drive versions are available for solar systems from elero:

VariEco M DC / -868 DC

- Mechanical limit switch
- Unidirectional radio (868 MHz)

Radio control

Wired



SunTop L-868 DC

- Mechatronic end position detection with soft cut-out
- Unidirectional radio control (868 MHz)



JA Soft DC

- Mechanical limit switch
- Quickon end piece (QuickConnect)





Applications	VariEco M DC	VariEco M-868 DC	SunTop L-868 DC	JA Soft DC
Page	136	136	136	136
Roller shutters	•	•		
Textile sun protection	•	•	•	
(Outdoor) venetian blinds				•

TOP functions	VariEco M DC	VariEco M-868 DC	SunTop L-868 DC	JA Soft DC
Mechatronic end position detection with soft cut-out			•	
Mechanical limit switch	•	•		•
Intelligent force measurement			•	
Independent drive system (no wiring to mains necessary)	•	•	•	•
Unidirectional radio control at 868 MHz (without routing function)		•	•	
End positions can be adjusted using the radio transmitter			•	
End positions can be adjusted with assembly cable			•	

Technical data	VariEco M DC	VariEco M-868 DC	SunTop L-868 DC	JA Soft DC
Rated torque (Nm)	2.5, 10 and 12	10 and 12	6 and 40	4 and 10
Rated speed (Upm)	16	16	50 and 12	33 and 26
Min. shaft diameter ab (mm)	50	50	63	–
Diameter (mm)	45	45	59	–
Length (mm)	491 and 511	491 and 511	558	260 (device without connection cable)
Protection class (IP)	44	44	44	44
Limit switch range (rev.)	35	35	40	85
Noiseless soft brake	•	•	–	•
Ambient operating temperature (°C)	-20 to +60	-20 to +60	-20 to +60	-20 to +60
Conformity	CE	CE	CE	CE
Plug-in connection cable, 3.0 m	•	•	•	
Connection cable 0.8 m				•

End position programming		VariEco M DC	VariEco M-868 DC	SunTop L40-868 DC	JA Soft DC
Top	Bottom				
To stop	Freely adjustable			•	
Freely adjustable	Freely adjustable	•	•	•	•

Solar drive systems

Drives



Roller shutter, textile sun protection,
(outdoor) venetian blind

VariEco M DC / -868 DC: mechanical limit switch, noiseless soft brake, min. shaft size $\varnothing = 50$ mm, 3.0 m plug-in connection cable, unidirectional radio control at 868 MHz (radio version only)

SunTop L-868 DC: mechatronic end position detection with soft cut-out, intelligent force measurement, upward/downward blocking detection, end positions adjustable with mounting cable and hand-held transmitter, min. shaft size $\varnothing = 63$ mm

JA Soft DC: mechanical limit switch, noiseless soft brake, 0.8 m connection cable with Quickon end piece (QuickConnect)

VariEco M (-868) DC

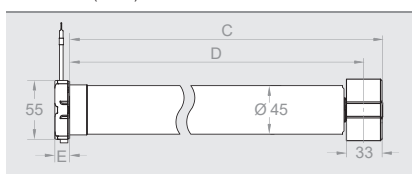

SunTop L-868 DC

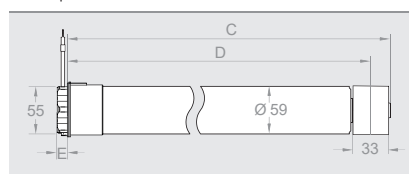

JA Soft DC

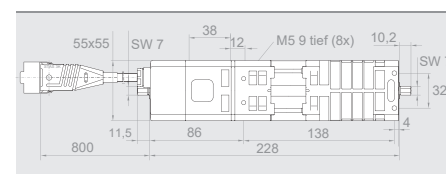

	VariEco M2.5/60 DC	VariEco M10 DC	VariEco M12 DC	VariEco M10-868 DC	VariEco M12-868 DC	SunTop L6/50-868 DC	SunTop L40-868 DC	JA 04 Soft DC	JA 10 Soft DC
Item number	34 600.0101	34 621.0101	34 611.0101	34 622.0101	34 612.0101	36 403.0001	36 352.0002	35 113.0001	35 093.0002

Technical data

Rated torque (Nm)	2.5	10	12	10	12	6	40	4	10
Rated speed (rpm)	60	16	16	16	16	50	12	33	26
Rated voltage (V DC)	12	12	12	12	12	12	12	12	12
Rated current (A)	3.0	3.75	3.5	3.75	3.5	8	10	4.0	8.5
Rated power consumption (W)	36	45	42	45	42	96	120	48	102
Noiseless soft brake	•	•	•	•	•	–	–	•	•
Operating time (min S2)	10	10	10	10	10	10	10	10	10
Length C (mm)	497	477	497	477	497	542	542	260	260
Length D (mm)	480	460	480	460	480	525	525	800	800
Length E (mm)	14	14	14	14	14	16	16	11.5	11.5
Weight (kg)	1.7	1.6	1.7	1.6	1.7	3.78	3.78	1.6	1.6
Ambient operating temperatur (°C)	-20 to +60	-20 to +60	-20 to +60	-20 to +60	-20 to +60	-20 to +60	-20 to +60	-20 to +60	-20 to +60

Accessories for the tubular drives, such as connection and assembly cables, adapter sets and motor bearings, can be found in the section “RevoLine M accessories” on page 72 and on the following page “Solar drive systems, control systems and accessories”. Accessories for the JA drives on page 115.

Suitable control systems and radio transmitters and sensors can be found in the section “Control systems” on page 182.

For RevoLine SunTop L40-868 DC, please use suitable adapter sets for RevoLine L RH on page 100.

Solar drive systems

Control systems and accessories

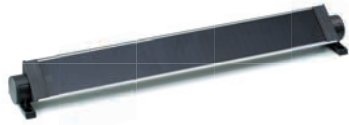

Combio-868 JA DC

- Unidirectional radio receiver for venetian blind DC drives (with connection cables and double-sided adhesive tape)

Energy unit

- Complete energy unit:
 - Solar module incl. battery with charge control (pre-charged and ready for use)
 - Plug connectors and 2 wall brackets

	Combio-868 JA DC	Energy unit
Item number	28 506.0005	22 150.0001

Technical data		
Rated voltage (V DC)	12 – 13.5	13.2
Rated current (A)	3.75	–
Rated power consumption (W)	45	–
Switching current (mA)	100	–
Protection class (IP)	56	44
Ambient operating temperature (°C)	-20 to +70	-20 to +60
Operating time (min. S2)	5	–
Dimensions L x W x H (mm)	100 x 40 x 15	523 x 83 x 50

Compatible accessories	
	Battery with charge control (LiFePo, 13.2 V, 2300 mAh)
Item number	13 709.8102

	Plug connector, energy unit / drive (for tubular drives)
Item number	13 306.9601

	Plug-in connection cable, 3.0 m (for tubular drives)
Item number	23 395.6001

	QuickConnect (required when using the drives without a control system and energy unit)
Item number	23 395.2701

	DC assembly cable
Item number	23 279.0001

Accessories and components



Radio transmitters
from page 182



Wireless sensors
From page 204

elero

Smart Home Home automation

Yubii Home	146.
Living comfort kit	149.
Sustainability kit	151.
Safety kit	153.
Roll-Control	154.
On/Off-Control	155.
Dimmer-Control	156.
LED Adaptor	157.
Smart-Control	158.
RGBW-Control	159.
Heat-Control Kit	160.
Motion-Control	161.
Flood-Control	162.
Smoke-Control	163.
CO Alarm-Control	164.
D/W-Control	165.
Plug-Control	166.
Push-Control	167.
Centero Home NXT	169.

Smart elero world

A smart home is primarily about making living safer and more comfortable as well as about saving energy. The daily routines of the users are facilitated by automatic scenes, voice commands and the remote control of devices. Smart home solutions are increasingly in demand – both for new buildings and for retrofitting. If you want to remain flexible, choose an open system that can also incorporate devices from other manufacturers.

Systems for every requirement:

As an international reference in building automation, we meet the high demands of the market and offer you smart home systems for every requirement.

Yubii® Home

The smart home system fully automates your house or flat and is a genuine all-in-one system offering a world full of possibilities. Versatile, flexible and reliable.

CENTEROHOME NXT by elero

For a smart application with the focus on privacy and sun protection, Centro Home NXT is a user-friendly and market-driven solution.

Yubii Home

The smart home system fully automates your house or flat and is a genuine all-in-one system offering a world full of possibilities.

Yubii Home will make your home smart and your life easier. The versatile gateway integrates products and radio protocols from elero and Nice. Countless devices from other brands can be incorporated into the system thanks to its compatibility with the Z-Wave® protocol.



Automation and intelligent links allow the user to benefit from more:

- Living comfort and quality of life
- Safety
- Sustainability and energy saving
- Cost saving

Yubii Home is the heart of the new smart home. The smart hub manages all smart devices and communicates with them. It receives the data from the Z-Wave sensors, processes them and has suitable operations carried out. The Amazon Alexa, Google Assistant and Siri Shortcuts voice assistants allow all applications to be controlled with ease by voice. Even from anywhere in the world – with the Yubii app on your smartphone or tablet. Almost all bidirectional elero radio drives and radio



receivers can be integrated into the Yubii Home smart home environment.

Indicated with this logo: works with **Yubii Home**

In addition, Yubii Home is compatible with more than 4,600 devices from other well-known manufacturers. Furthermore, the gateway can support an IP camera and up to fifteen devices by means of app plug-in.

CENTERO HOME NXT

For a smart application with the focus on privacy and sun protection, Centero Home is a user-friendly and market-driven solution. A modular system, which also permits contemporary extensions with home technology equipment from other manufacturers.

Two different apps for specialists and users:

- Centero Connect – the installation app for your specialist partner
- Centero Home NXT – the application app for convenient operation

Centero Home NXT is an ideal introduction to the smart home world. The monitoring, control and automation of home automation products is possible by radio control (868 MHz, 433 MHz), IP and infrared. Centero Home NXT can be used both in the cloud and locally in a WLAN. All functions related to sun protection and roller shutter control are covered. In addition, home automation and security components as well as lifestyle products from other manufacturers can be integrated.



Yubii® Home

Your life gets better.

Yubii Home is the heart of a new smart home. A system that takes care of the comfort and safety of the whole family and can also reduce energy consumption. One of these value propositions is at the forefront of the mind of all consumers when purchasing a smart home system. That is why we have put together starter kits based on these needs, starting on page 149.



**Your home will become smart
and your life easier.**



Control your home with your voice.

Just a few words, and things happen in the easiest way possible. Whether Amazon Alexa, Google Assistant or Siri Shortcuts – it does not get more comfortable than this.



Manage your smart home via Yubii-App with your smartphone or tablet.

The intuitive dashboard is designed to capture what's going on at home at a glance. As soon as the app is opened, the most important functions are accessible. So you have everything in view – no matter where you are.





Yubii Home Gateway



Yubii Home makes your home smart. The gateway enables automation that is tailored to people's lifestyles and provides living comfort, safety and sustainability. It manages all smart devices and communicates with them. It receives the data from the Z-Wave sensors, processes them and has suitable operations carried out.

The Amazon Alexa, Google Assistant and Siri Shortcuts voice assistants allow all applications to be controlled with ease by voice. With the Yubii app on your smartphone or tablet, you always have your home in view – within your own four walls and wherever you might be.

Bidirectional routing with ProLine 2



ProLine 2, the bidirectional radio system from elero, is more reliable, powerful and transparent than unidirectional radio standardp. At the heart of the technology (868 MHz) are bidirectional radio components (transceivers) that are capable not only of receiving, but also of confirming and relaying the signalp. As soon as a command has been executed on the drive, the user receives feedback and can be sure that the commands are being executed correctly.

Z-Wave wireless network



The Z-Wave wireless network is a wireless communication standard developed for home automation, which is used in sensors, modules, switches and other smart devicep. It enables convenient remote control of devicep. The radio communication has been optimised for low energy consumption and high communication security. With Z-Wave Plus, a new generation has been developed for even more functionality and compatibility.

Communication with Yubii Home

Radio drives and receivers – indicated in the catalogue by the ^{works with} **Yubii Home** symbol – communicate directly with the gateway, and the same applies to sensorp. Radio control units, such as the VarioCom-868 hand-held radio transmitter, are taught into the drive or receiver and are not connected to the gateway.

Areas of application and top functions

Your home in a single device: roller shutters, venetian blinds, awnings, interior sun protection, gates, windows and doors, lighting, electrical household appliances, heating and irrigation systems as well as the entire home entertainment system can be controlled and integrated into automatic processes with a simple command. Appropriate sensors detect water leaks, carbon monoxide, fires, temperature, lighting conditions, motion and any tampering.

	Yubii Home Gateway	Living comfort kit	Sustainability kit	Safety kit	Roll-Control	On/Off-Control	Dimmer-Control	LED Adaptor	Smart-Control
Page	146	149	151	153	154	155	156	157	158
Roller shutters / interior shading	•				•				
Awnings / ZIP / exterior shading	•				•				
Venetian blinds	•				•				
Lighting	•		•			•	•	•	
Heating	•		•						
Sensor control	•	•	•	•					•
Bidirectional-capable transmitter/receiver	•								
Z-Wave(Plus)-capable transmitter/receiver	•	•	•	•	•	•	•	•	•

	RGBW-Control	Heat-Control Kit	Motion-Control	Flood-Control	Smoke-Control	CO Alarm-Control	D/W-Control	Plug-Control	Push-Control
Page	159	160	161	162	163	164	165	166	167
Lighting	•							•	
Heating		•							
Motion sensor			•						
Temperature sensor		•	•	•	•	•	•		
Light sensor			•						
Flood sensor				•					
Smoke sensor					•				
CO Sensor						•			
Magnetic contact sensor							•		
Z-Wave(Plus)-capable transmitter/receiver	•	•	•	•	•	•	•	•	• <i>(Transmitter only)</i>
Colour variants available							•		•
(Rechargeable) battery operated		• <i>(Rechargeable battery cannot be replaced)</i>	•	•	•	•	•	•	•
LED indicator		•	•	•	•	•	•	•	
Audible alarm			•	•	•	•			
Open/closed detection							•		
Further devices can be switched								•	

Yubii® Home

Modern home automation from elero



Smart control for increased living comfort.

Yubii Home Gateway	
Item number	3016 1604 0301
Technical data	
Processor	Single-Core Arm Cortex A7 (900 MHz)
Operating memory	512 MB DDR3L
Hard disk	4 GB eMMC
Power supply	5 V DC max. 1 A (adapter included in scope of delivery)
Network interface	WLAN
Ambient operating temperature (°C)	0 to 40
Conformity with EU standards	RED 2014/53/EU RoHS 2011/65/EU
Radio protocol (MHz)	433 (433.05 – 434.04) 868 (868.0 – 869.65) Z-Wave (700 series) (868.0 – 868.6 and 869.7 – 870.0) WLAN (2400 – 2483)
WLAN connection	802.11 b/g/n/a/ac
Operating humidity	max. 75% relative humidity (non-condensing)
Power connection	USB Micro B
Dimensions (mm)	178 x 110 x 31

For a complete list of the control units and devices compatible with Yubii Home, visit www.elero.com/yubiihome

Properties

- Thank Z-Wave compatible with more than 4,600 devices from other manufacturers
- Fast configuration process
- Simple and complex automation systems such as block scenes, LUA events, quick apps (programmable via Browser)
- Future-proof system
- Zukunftssicheres System
- Ingenious and sophisticated design
- Number of integrable devices:
40 elero, 40 Nice, 40 Z-Wave, 1 IP camera, 20 szenes, 10 quick-apps, 5 plug-ins
- Voice control (language version depends on the provider of the voice interface)

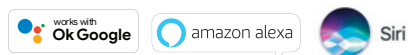

- IP video camera support
- Yubii app available for Android and iOS



That says a lot about Yubii Home

Yubii Home is one of the most advanced smart home management units in the world. Components with modern technology ensure a stable, high-performance smart home system. The Z-Wave technology enables the integration of more than 4,600 products from other manufacturers. Control your privacy and sun protection, electronics and household appliances, lighting, HVAC, alarm, monitoring and irrigation systems at the touch of a button or with a gesture or word.



Compatible

- With more than 4,600 products from other manufacturers (Z-Wave) such as Philips Hue, Netatmo, Sonos, D-Link, Yale, DSC and many more
- With almost all radio drives, receivers and sensors of the elero and Nice brands (868 MHz bidirectional radio technology)



Secure

- Encryption as for online banking
- Encrypted data transmission to protect both local and external connections (use of security systems such as WAF and anti-DDoS, encryption of TLS protocol communication and protection of passwords with bcrypt)
- Yubii Home can be operated without Internet or cloud access and provide important functions at home

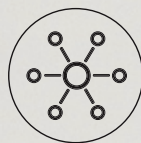

Flexible

- For new buildings and retrofitting
- Completely wireless system – no effort to install
- Benefit-oriented starter kits for the initial installation
- The system can be adapted and expanded at any time



Living comfort

Modern home automation makes a decisive contribution to improving living comfort. For users who want to save time and fully enjoy their home, the living comfort kit is the first choice:

Installed in a socket or wall switch, **On/Off control** can switch on or monitor electrical appliances and lights and control most household appliances. With **Plug-Control**, you can integrate lights, music systems and other consumers into the smart home system and activate them with it. **Motion-Control** provides even more living comfort. In addition to motion detection, this sensor can be used to measure the temperature and light intensity. The devices integrated into the system can be activated in relation to the time or sensor signals and, of course, at the touch of a button. Further-more, it is possible to integrate them into scenep.

Push-Control excels with an innovative design and makes the feel-good experience perfect. Placed next to the bed, one press is enough, for example, to trigger a “morning scene”: soft lighting, soft music while the coffee machine is switched on.

Enjoying life at home

Living comfort kit



On/Off-Control



Motion-Control



Plug-Control



Push-Control (white)

works with
Yubii® Home

Highlights On/Off-Control (p. 155)

- To control two electrical consumers
- Active power and energy measurement
- Z-Wave signal repeater
- Works with different types of switches – push-buttons, toggle switches, three-way switches etc.

Highlights Motion-Control (p. 161)

- Detects even the slightest changes in motion and temperature
- Unique earthquake detection function
- Easy to attach to surfaces, ceilings or walls thanks to innovative mounting bracket
- Motion notification on your smart phone or tablet
- LED indicator (motion, operating mode, temperature level)

Highlights Plug-Control (p. 166)

- For lamps, fans, household appliances, home entertainment and other devices
- Useful if the socket is difficult to access
- Visualisation of the power consumption by coloured crystal LED ring
- Power consumption can be displayed via Yubii Home
- Can be used as a night light

Highlights Push-Control (p. 167)

- Can be installed anywhere in your house
- Extremely easy to install – simply add to the system and place on the surface of your choice
- Only available in white in the living comfort kit

	Living comfort kit
Item number	28 981 0001
Product contents	On/Off-Control (p. 155) Motion-Control (p. 161) Plug-Control (p. 166) Push-Control (p. 167)

The highlights on this page focus only on the most important product features. A full description of the items included in the kit can be found on the following pages.



Sustainability

With our sustainability kit, you can save a great deal of energy without any effort and enjoy an ideal indoor climate in your smart home:

Motion-Control detects movements in the room and also measures the temperature and light intensity. Installed in a socket or wall switch, **On/Off-Control** can switch on or monitor electrical appliances and lights and can control most household appliances.

Heat-Control regulates the room temperature for smart heating management and **D/W-Control** knows whether windows or doors are open, among other things. Together, the four of them are unbeatable. Ventilation and heating can thus be managed remotely and automatically adapted to the needs of your family. In addition, users consequently consume less energy and protect the environment.

Everything for our environment

Sustainability kit



On/Off-Control



Heat-Control



Motion-Control



D/W-Control (white)

	Sustainability kit
Item number	28 985 0001
Product contents	On/Off-Control (p. 155) Heat-Control Kit (p. 160) Motion-Control (p. 161) D/W-Control (p. 165)

works with

Yubii® Home

Highlights On/Off-Control (p. 155)

- To control two electrical consumers
- Active power and energy measurement
- Z-Wave signal repeater
- Works with different types of switches – push-buttons, toggle switches, three-way switches etc.

Highlights Heat-Control Kit (p. 160)

- For various heating valves
- Easy to install – no tools required
- Efficient heating management
- External temperature sensor for placement anywhere in the room
- Schedule mode: heating schedule for the entire week
- Temperature is indicated by the light colour in the ring
- Automatic calibration
- Frost protection and descaling function

Highlights Motion-Control (p. 161)

- Detects even the slightest changes in motion and temperature
- Unique earthquake detection function
- Easy to attach to surfaces, ceilings or walls thanks to innovative mounting bracket
- Motion notification on your smart phone or tablet
- LED indicator (motion, operating mode, temperature level)

Highlights D/W-Control (p. 165)

- For windows, doors, gates, roller shutters
- Built-in temperature sensor
- Turns down the heating when the window is open
- Detects any tampering when removing or opening
- Easy to install
- Visual LED indicator of the device status
- Available only in white in the sustainability kit

The highlights on this page focus only on the most important product features. A full description of the items included in the kit can be found on the following pages.



Safety

Give your customers a good feeling by protecting their home. They will feel comfortable there with the safety kit.

Motion-Control detects movements in the room and also measures the temperature and light intensity. **Smoke-Control** is an intelligent smoke and fire detector and **Flood-Control** alerts to flooding and any tampering, among other things.

Together, the three form a powerful team. Potential dangers are predicted, people are warned and automatic sequences can be stored as a scene or condition in Yubii Home, for example to allow all motorised roller shutters to open if **Smoke-Control** detects smoke.

To protect the house and residents

Safety kit



Motion-Control



Smoke-Control



Flood-Control

works with

Yubii® Home

Highlights Motion-Control (p. 161)

- Detects even the slightest changes in motion and temperature
- Unique earthquake detection function
- Easy to attach to surfaces, ceilings or walls thanks to innovative mounting bracket
- Motion notification on your smart phone or tablet
- LED indicator (motion, operating mode, temperature level)

Highlights Flood-Control (p. 162)

- Detects water leaks, floods and fires
- Built-in LED and audible alarm
- Compact design, floatable sensor
- Placement on the floor or wall mounting with extended flood sensor probe
- Can communicate with wired alarm systems
- Compact design

Highlights Smoke-Control (p. 163)

- Optical smoke detection (at the earliest stage of the fire, often before flame formation and a significant increase in temperature)
- Integrated temperature sensor (signals when the defined temperature threshold is exceeded)
- Alarm is signalled by loud noises, visual display and sending of control commands
- Alarm scenes can be displayed: e.g. open roller shutter, switch on light, message to smart phone
- Compact, attractive design
- Three sensitivity levels of the sensors according to EN 14604:2005
- Built-in detector for housing opening

	Safety kit
Item number	28 983 0001
Product contents	Motion-Control (p. 161) Flood-Control (p. 162) Smoke-Control (p. 163)

The highlights on this page focus only on the most important product features. A full description of the items included in the kit can be found on the following pages.

Roll-Control

Flush-mounted control unit
for privacy and sun protection



Roll-Control is a device used to control motorised roller shutters, venetian blinds, awnings, roller blinds and gates and enables their precise positioning. The product is also equipped with a power and energy monitoring function. Roller shutters, etc. can be integrated into automatic sequences and scenes and/or controlled as a group via the Z-Wave network in connection with Yubii Home. It is also possible to manually control the blinds with a conventional wall switch/push-button to which Roll-Control is directly connected.

works with
Yubii® Home

Properties

- For integration into Yubii Home: automatic sequences, scenes, control by app on your smart phone and tablet
- Use with single-phase AC motors with electronic or mechanical limit switches
- Works with different types of switches – push-buttons, toggle switches, three-way switches etc.
- Function for active power and energy measurement
- Z-Wave signal repeater
- Supports the following Z-Wave network security modes:
 - S0 with AES-128 encryption
 - S2 with PRNG-based encryption

	Roll-Control
Item number	3016 1823 0301

Technical data

Power supply	100 – 240V ~ 50/60Hz
Rated load current (A)	1.7 (Resistive loads) for motors with compensated power factor (inductive loads)
Ambient operating temperature (°C)	0 to +35
Supported motor types	Single-phase AC motors
Limit switches required	Electronic and mechanical
Power consumption (W)	up to 0.8
For installation in wall switch boxes (mm)	Ø ≥ 50 Depth ≥ 60
Radio frequency (MHz)	868.4 or 869.8 (EU)
Conformity with EU directives	RoHS 2011/65/EU RED 2014/53/EU
Range (m)	up to 30 (in buildings)
External dimensions L x W x H (mm)	42.5 x 38.25 x 20.3

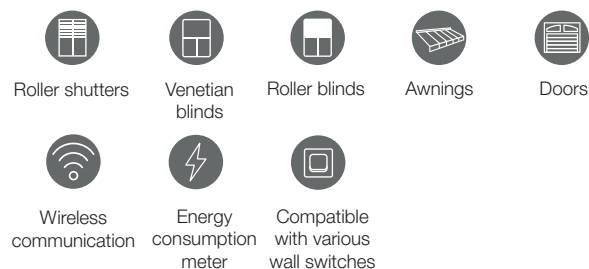

On/Off-Control

Flush-mounted switch control



On/Off-Control is used to switch up to two electrical appliances and lights on and off and to measure the current and energy consumption. Electrical appliances can be integrated into automatic sequences and scenes and/or controlled as a group via the Z-Wave network in connection with Yubii Home. The compact size of the unit makes it the smallest of its kind and allows the product to be installed in wall switches or enclosures. On/Off-Control can be controlled with a directly connected wall switch or push-button.

	On/Off-Control
Item number	3016 1803 0301

Technical data	
Power supply	100 – 240 V ~50/60Hz
Rated load current (A) nach IEC-Norm	6.5 per channel 10 in total
Ambient operating temperature (°C)	0 to +35
For installation in wall switch boxes (mm)	Ø ≥ 50 Depth ≥ 60
Radio protocol	Z-Wave (500 series chip)
Radio frequency (MHz)	868.4 or 869.8 (EU)
Radio transmission power (dBm)	up to 6 (EIRP)
Conformity with EU directives	RED 2014/53/EU RoHS 2011/65/EU
Range (m)	Up to 50 outdoors and up to 40 indoors (depending on terrain and building structure)
External dimensions L x W x H (mm)	42.5 x 38.25 x 20.3

Included in these kits:



Living comfort
Page 149



Sustainability
Page 151

works with

Yubii® Home

Properties

- To control two electrical consumers
- For integration into Yubii Home: automatic sequences, scenes, control by app on your smart phone and tablet
- Active power and energy measurement
- Z-Wave signal repeater
- Works with different types of switches – push-buttons, toggle switches, three-way switches etc.
- Supports the following Z-Wave network security modes:
 - S0 with AES-128 encryption
 - S2 with PRNG-based encryption



On/off switch



Light management



Device management



Energy consumption meter



Compatible with various wall switches

Dimmer-Control

Flush-mounted light switch control



Dimmer-Control is used to control different types of light sources. The lighting can be integrated into automatic sequences and scenes and/or controlled as a group via the Z-Wave network in connection with Yubii Home. It can also be operated with the directly connected wall switch. The Dimmer-Control algorithm for intelligent light source detection facilitates configuration and ensures high compatibility of the device. It has an automatic overload protection cut-off and soft-start function (can be combined with LED Adaptor, p. 157).

works with
Yubii® Home

Properties

- Intelligent light source detection
- For integration into Yubii Home: automatic sequences, scenes, control by app on your smart phone and tablet
- Active power and energy measurement function
- Works with different types of switches – push-buttons, toggle switches, three-way switches etc.
- Soft start function
- LED diode signalling for different statuses: inclusion, calibration and device menu position
- Advanced configuration options
- Z-Wave signal repeater
- Can be operated without a neutral conductor
- Dimmable control of:
 - 230V-operated conventional incandescent lamps and halogen light sources
 - 12V-operated ELV halogen lamps and dimmable LED lamps (with electronic transformers)
 - 12V-operated MLV halogen lamps (with ferromagnetic transformers)
 - Dimmable LED lamps and dimmable compact fluorescent lamps CFL
- Non-dimmable control of:
 - Compact fluorescent lamps CFL with electronic ballast
 - Fluorescent lamps CFL with electronic ballast
 - LED lamps (power factor > 0.7)

	Dimmer-Control
Item number	3016 1813 0301

Technical data

Power supply	100 – 240V ~ 50/60Hz
Energy consumption (W)	< 1.3 W
Ambient operating temperature (°C)	0 to +35
Betriebsstrom (A)	0.25 – 1.1
For installation in wall switch boxes (mm)	Ø ≥ 50 Depth ≥ 60
Radio protocol	Z-Wave
Radio frequency (MHz)	868.4 or 869.8 (EU)
Radio transmission power (dBm)	up to 6 (EIRP)
Conformity with EU directives	ROT 2014/53/EU RoHS 2011/65/EU
Range (m)	Up to 50 outdoors Up to 30 in buildings (depending on the terrain and building structure)
External dimensions L x W x H (mm)	42.5 x 38.25 x 20.3



Brightness control



Protection index



Energy consumption meter



Fade In Function

LED Adaptor

Flush-mounted light dimmer



Only in conjunction
with Dimmer-Control!

The LED adaptor is a device that has been developed to expand the Dimmer-Control. It enables light sources to be dimmed with minimum power consumption and prevents flickering of LED lamps or afterglow of energy-saving lamps. It is only possible to dim light sources that are clearly marked as dimmable.

Properties

- Dimming of light sources
- Minimum power consumption of the light sources
- Prevents flickering and afterglow of LED equipment (in combination with Dimmer-Control, p.156)



Brightness control

	LED Adaptor
Item number	3012 0751 0101

Technical data	
Power supply	100 – 240V ~50/60Hz
Ambient operating temperature (°C)	0 to +35
Power consumption (W)	< 1.4
External dimensions L x W x H (mm)	31 x 21.6 x 13
Conformity with EU directives	RoHS 2011/65/EU LVD 2014/35/EU EMC 2014/30/EU

Smart-Control

Intelligent radio receiver



Smart-Control extends the functionality of wired sensors and other devices and makes them “smart”. They can be integrated into automatic sequences and scenes and/or controlled as a group via the Z-Wave network in connection with Yubii Home. In addition to wireless communication, devices, for example, can be switched on/off and data from sensors can be read out. The original functions of the device/sensor are not impaired by Smart-Control. The intelligent radio receiver can therefore also be used with alarm systems.

works with

Yubii® Home

Properties

- Enables the connection of sensors:
 - up to six DS18B20 sensors, one DHT sensor, two dual-wire analogue sensors, two triple-wire analogue sensors, two binary sensors
- Built-in temperature sensor
- Z-Wave signal repeater
- Supports the following Z-Wave network security modes:
 - S0 with AES-128 encryption
 - S2 with PRNG-based encryption

	Smart-Control
Item number	3016 1704 0301

Technical data

Power supply (V DC)	9 – 30 (±10%)
Inputs	Two 0-10 V or digital inputs One serial single-wire input
Outputs	Two potential-free outputs (for controlling external circuits)
Supported digital sensors	6 x DS18B20 or 1 x DHT22
Maximum output current (mA)	150
Maximum output voltage	30V DC / 20V AC (±5%)
Ambient operating temperature (°C)	0 to +40
Radio protocol	Z-Wave (500 series chip)
Radio transmission power (dBm)	max. 7 (EIRP)
Radio frequency (MHz)	868.4 or 869.8 (EU)
Conformity with EU directives	RoHS 2011/65/EU RED 2014/53/EU
Range (m)	Up to 50 outdoors Up to 40 in buildings (depending on the terrain and building structure)
Dimensions L x W x H (mm)	29 x 18 x 13



Extension of the range of Z-Wave networks



Reading out data from sensors



Wireless communication



Switching devices on and off

RGBW-Control

Flush-mounted light and sensor control



RGBW-Control is used to control light sources, such as LED strips and coloured LEDs, and allows the light intensity and light colour to be changed. They can be integrated into automatic sequences and scenes and/or controlled conveniently by the Yubii app on your smart phone or tablet via the Z-Wave network in connection with Yubii Home. In addition, the device supports up to four analogue sensors and has a function for power and light measurement.

	RGBW-Control
Item number	3016 1713 0301

Technical data	
Power supply (V DC)	12 / 24 (± 10%)
Rated load current (A)	6 per channel 12 in total for all outputs
Power (W)	144 combined at 12 V 288 combined at 24 V
Ambient operating temperature (°C)	0 to +40
Radio protocol	Z-Wave (500 series chip)
Radio frequency (MHz)	868.4 or 869.8 (EU)
Radio transmission power (dBm)	up to -1 (EIRP)
Conformity with EU directives	RoHS 2011/65/EU EMC 2004/108/EC R& TTE 1999/5/EC
Recommended cable cross-section	0.2 – 2.0 mm ² (24–14 AWG) (depending on the load current)
Range (m)	up to 50 outdoors up to 30 in buildings (depending on the terrain and building structure)
External dimensions L x W x H (mm)	42 x 37 x 17

works with

Yubii® Home

Properties

- For LED strips, RGB/RGBW LEDs and 12V-operated or 24V-operated light sources
- Control of light intensity and light colour, on/off
- For integration into Yubii Home: automatic sequences, scenes, control by app on your smart phone and tablet
- In addition, up to four 0 – 10V analogue sensors are supported (e.g. temperature sensors, humidity sensors, wind sensors, air quality sensors, light sensors)
- All IN and OUT connections can be configured by the user for LED control or 0 – 10V signal output
- Can be used as a dimmer in combination with halogen lamps
- Measurement of the current and historical power consumption starting at the installation
- Control via any Z-Wave controller possible
- Microprocessor-controlled
- For installation in standard wall switch boxes
- Z-Wave signal repeater



Heat-Control Kit

Intelligent radiator control



Heat-Control

Temperature sensor

A smart radiator thermostat and a temperature sensor are included in the Heat-Control kit. The temperature measurement sensor can be placed anywhere in the room. The heat level is automatically adjusted. An innovative room analysis algorithm calculates the time needed to reach the desired temperature based on the room volume. Heat-Control can be controlled manually, by voice command and app at any time. A schedule mode enables temperature management for the whole week. The heating can be integrated into automatic sequences and scenes via the Z-Wave network in connection with Yubii Home.

Heat-Control Kit	
Item number	6125

Technical data of Heat-Control

Power supply (V)	3.7 Li-poly rechargeable battery (not replaceable)
Charging connection	Micro-USB
Charger voltage (V DC) (charger not included in scope of delivery)	5
Minimum charging current (A)	0.5
Ambient operating temperature (°C)	0 to 40
Supported valves	M30 x 1.5, Danfoss RTD-N, Danfoss RA-N
Maximum water temperature (°C)	90
Accuracy of the temperature measurement (°C)	0.5 (within a range of 0 to 40)
Radio protocol	Z-Wave (500 series chip) (S2-capable)
Radio frequency (MHz)	868.0 – 868.6
Conformity to standards	RoHS 2011/65/EU, RED 2014/53/EU
Range (m)	up to 40 (depending on building structure)
Dimensions Ø x H (mm)	56x74 (without adapter), 56x87 (with adapter)

Technical data of temperature sensor

Power supply (V)	3.0 CR2032 battery (included in scope of delivery)
Radio frequency (MHz)	2402 – 2480
Max. transmission power (dBm)	max. 1
Ambient operating temperature (°C)	0 to +40
Conformity to standards	RoHS 2011/65/EU, RED 2014/53/EU
Dimensions Ø x H (mm)	38 x 12

Included in this kit:



works with
Yubii® Home

Properties

- For three different heating valves: M30 x 1.5, Danfoss RTD-N and Danfoss RA-N
- Easy to install – no tools required
- Efficient heating management
- For integration into Yubii Home: automatic sequences, scenes, control by app on your smart phone and tablet
- Built-in battery rechargeable via standard micro USB port
- External temperature sensor for placement anywhere in the room
- Schedule mode: heating schedule for the entire week
- Temperature is indicated by the light colour in the ring
- Automatic calibration
- Frost protection and descaling function
- Supports the following Z-Wave network security modes:
 - S0 with AES-128 encryption
 - S2 with PRNG-based encryption
- Scope of delivery: Heat-Control and temperature sensor



Motion-Control

Motion, light and temperature sensor



The multi-sensor detects motion and measures the ambient temperature and light intensity. Any tampering of the device is detected by the integrated accelerometer. Motion-Control is battery operated and can be quickly and easily mounted on walls and ceilings or simply set up. Sensor signals can be integrated into automatic sequences via the Z-Wave network in connection with Yubii Home. Motion-Control can also be used for lighting scenes and security monitoring systems. Motion signals to the smartphone are also possible. The LED indicator is used to signal motion and the temperature level and operating mode.

	Motion-Control
Item number	3016 1774 0301

Technical data	
Power supply	CR123 A battery, 3.0 V DC (battery included in scope of delivery)
Rechargeable battery life	Approx. 2 years (with default settings)
Recommended installation height (m)	2.4
Ambient operating temperature (°C)	0 to +40
Measured temperature range (°C)	-20 to +100
Accuracy of the temperature measurement (°C)	0.5 (within range of 0 to +40)
Accuracy of the temperature measurement (LUX)	0 to 32.000
Radio protocol	Z-Wave
Radio frequency (MHz)	868.4 Mhz or 869.8 MHz (EU)
EU directive conformity	RED 2014/53/EU RoHS 2011/65/EU
Range (m)	up to 50 outdoors up to 40 in buildings (depending on the terrain and building structure)
Dimensions H x W x Ø (mm)	46 x 46 (mounting bracket +2 mm)

Included in these kits:



Living comfort
Page 149



Sustainability
Page 151



Safety
Page 153

works with

Yubii® Home

Properties

- Detects even the slightest changes in motion and temperature
- Unique earthquake detection function
- For integration into Yubii Home: automatic sequences and lighting scenes
- Easy to attach to surfaces, ceilings or walls thanks to innovative mounting bracket
- Used indoors
- Motion notification on your smart phone (can be deactivated)
- LED indicator (motion, operating mode, temperature level) that can be switched off
- Battery operated
- Wireless communication via Z-Wave protocol
- Wireless software update
- Supports the following Z-Wave network security mode:
 - S0 with AES-128 encryption



Motion sensor



Light sensor



Temperature sensor



Acceleration sensor



Direct notification

Flood-Control

Flood and temperature sensor



Included in this kit:



works with
Yubii® Home

The multifunctional sensor is more than an ordinary water detector – it detects the smallest water leaks and the integrated temperature sensor monitors the temperature of the floor, for example, or issues an alert in the event of a fire. Flooding is signalled by the integrated LED and audible alarm. Sensor signals can be integrated into automatic sequences via the Z-Wave network in connection with Yubii Home. Due to its compact size, Flood-Control can be positioned anywhere – this is possible on walls due to an extended flood sensor probe.

Properties

- Detects water leaks, floods and fires
- Flood-Control can be integrated into automatic sequences via the Z-Wave network in connection with Yubii Home
- Built-in LED and audible alarm
- Compact design, floatable sensor
- Placement on the floor
- Wall mounting with extended flood sensor probe (wired)
- Can communicate with wired alarm systems via a Z-Wave network
- Battery operated or VDC operated
- Wireless software update

	Flood-Control
Item number	3016 1723 1201

Technical data

Battery type	CR 123A (included in scope of delivery)
Power supply (V DC) (optional)	12 – 24
Maximum voltage at the output terminals (V)	24 DC / 20 AC
Measured temperature range (°C)	0 to +40 (battery operation) -20 to +100 (VDC operation)
Accuracy of the temperature measurement (°C)	0.5 (within a range of 0 to 40)
Ambient operating temperature (°C)	0 to +40 (battery operation) -20 to +70 (VDC operation)
Radio protocol	Z-Wave
Radio frequency (MHz)	868.4 or 869.8 (EU)
Conformity with EU directives	RoHS 2011/65/EU RED 2014/53/EU
Range (m)	up to 50 outdoors up to 40 indoors (depending on the terrain and building structure)
Dimensions Ø x H (mm)	72 x 28



Smoke-Control

Smoke sensor



Smoke-Control signals an alarm by sound and visual flashing and by sending Z-Wave control commands. The optical sensor already detects smoke at an early stage of the fire. In addition, the device has a built-in, programmable temperature sensor. Smoke-Control can be mounted on a wall or ceiling. The LED indicator signals fires and the operating mode and can be used to see if the device is within a Z-Wave network.

Smoke-Control	
Item number	3016 1734 0301
Technical data	
Battery type (V DC)	CR123A 3.0 (included in scope of delivery)
Ambient operating temperature (°C)	0 to +55
Operating humidity (%)	0 to 93
Measured temperature range (°C)	-20 to +100
Accuracy of the temperature measurement (°C)	0.5 (within 0 to +55)
Sensitivity to smoke	First level - 1.20 +/- 0.5% obs/ft Second level - 1.80 +/- 0.5% obs/ft Third level - 2.80 +/- 0.5% obs/ft
Noise level of the alarm siren (dBA)	85 (at 3 metres)
Radio transmission power (dBm)	up to -5 (EIRP)
Radio protocol	Z-Wave
Radio frequency (MHz)	868.4 or 869.8 (EU)
Conformity with EU directives	EN 14604:2005 RED 2014/53/EU RoHS 2011/65/EU
Range (m)	up to 50 outdoors up to 30 in buildings (depending on the terrain and building structure)
Dimensions Ø x H (mm)	65 x 28

Included in this kit:



works with
Yubii® Home

Properties

- Optical smoke detection (already at a very early stage of the fire)
- Integrated temperature sensor (signals when a defined temperature threshold is exceeded)
- Alarm is signalled by loud noises, visual display and the transmission of Z-Wave control commands
- Smoke-Control can be integrated into automatic processes via the Z-Wave network in connection with Yubii Home – alarm scene: e.g. opening roller shutters, switching on light, message on the smart phone
- Battery operated
- Compact, attractive design
- Three sensitivity levels of the sensors according to EN 14604:2005
- Built-in detector for housing opening
- Built-in Z-Wave range tester
- Wireless software update
- Self-test function, which can also be performed manually to test the operation of the Smoke-Control
- Efficiency test is automatically carried out every ten seconds to detect potential malfunctions
- Supports the following Z-Wave network security mode:
 - S0 with AES-128 encryption
- Not suitable for installation near moisture or dust



Smoke sensor



Temperature sensor



Acoustic / visual alarm



Effective protection



Excellent monitoring

CO Alarm-Control

Compact carbon monoxide detector



works with

Yubii Home

Thanks to its high sensitivity, CO Alarm-Control detects the presence of carbon monoxide (CO) gas at an early stage to prevent carbon monoxide poisoning. The alarm is signalled with a built-in siren, a flashing LED indicator and by sending information to Z-Wave network devices. In addition, the device is equipped with a temperature sensor. In connection with Yubii Home, the carbon monoxide concentration is displayed in a graph and stored in the system memory. This allows the amount of CO in rooms to be monitored to prevent health restrictions in the long term. Only suitable for wall mounting.

Properties

- Carbon monoxide (CO) detection
- Integrated temperature sensor
- Detects even low CO concentration levels
- Alarm is signalled with a built-in siren and LED diode
- Alarm-Control can be integrated into automatic sequences via the Z-Wave network in connection with Yubii Home – for example as a message on your smart phone
- Can be used as a stand-alone carbon monoxide detector
- Supports the following Z-Wave network security mode:
 - S0 with AES-128 encryption
- Battery operated
- Only suitable for wall mounting

	CO Alarm-Control
Item number	3016 1643 0301

Technical data

Battery type	CR123A 3.0 V (battery included in scope of delivery)
Service life under typical conditions	8 years
Measurement range of CO concentration (ppm)	0 to 450
Measurement accuracy	± 10 ppm / ± 5 %
Ambient operating temperature (°C)	0 to +50
Alarm response times with default settings	50 ppm 60 – 90 min 100 ppm 10 – 40 min 300 ppm < 1.5 min
Noise level of the alarm siren (dBA)	85 (at 3 metres)
Radio transmission power (dBm)	up to -5 (EIRP)
Radio protocol	Z-Wave (500 series chip)
Radio frequency (MHz)	868.4; 868.42 or 869.8 (EU)
EU directive conformity	RED 2014/53/EU RoHS 2011/65/EU EN 50291-1:2010
Range (m)	Up to 40 in buildings (depending on the terrain and building structure)
Dimensions Ø x H (mm)	65 x 28



Carbon monoxide sensor



LED light display



Temperature sensor



Audible alarm

D/W-Control

Contact sensor with temperature measurement



D/W-Control is a wireless, battery-operated magnetic contact sensor. The opening is detected by separating the sensor body and the magnet. The sensor can be used in connection with Yubii Home to trigger scenes and wherever information about the opening or closing of doors, windows, garage doors etc. is required. In addition, D/W-Control is equipped with a built-in temperature sensor.

D/W-Control	white	brown	black
Item number	3016 1743 0301	3016 1783 0301	3016 1793 0301

Technical data	
Battery type	ER 14250 1/2 AA, 3.6V DC (battery included in scope of delivery)
Rechargeable battery life	Approx. 2 years (with default settings)
Ambient operating temperature (°C)	0 to +40
Measured temperature range (°C)	0 to +60
Accuracy of the temperature measurement (°C)	± 0.5
Radio protocol	Z-Wave (500 series chip)
Radio frequency (MHz)	868.4 (EU)
EU directive conformity	RED 2014/53/EU RoHS 2011/65/EU
Colour	white brown black
Range (m)	Up to 50 outdoors Up to 40 in buildings (depending on the terrain and building structure)
Dimensions H x W x H (mm)	71 x 18 x 18

Included in this kit¹:



works with **Yubii® Home**

Properties

- For windows, doors, gates, roller shutters
- The opening is detected by separating the sensor body and the magnet
- Built-in temperature sensor
- D/W-Control can be integrated into automatic sequences via the Z-Wave network in connection with Yubii Home – for example to turn down the heating when the window is open
- Battery operated
- Detects any tampering when removing or opening
- Easy to install
- Visual LED indicator for visualisation of the device status
- For use inside buildings only
- Supports the following Z-Wave network security mode:
 - S0 with AES-128 encryption



Contact sensor



Tamper protection



Temperature sensor



Safety system component

Available in these colours



¹ only available in white in the living comfort kit

Plug-Control

Plug & Play



Plug-Control is an intelligent plug & play socket adapter with current measuring function. It can be used wherever electrical appliances with a maximum power of 2.5 kW need to be controlled, while monitoring the power consumption conveniently and maintenance-free. The crystal LED ring informs about the current load of the connected device by changing its colour visually. In connection with Yubii Home, the plugged-in device can become part of scenes or sequences and be operated with the Yubii app or a voice command.

Included in this kit:



works with
Yubii® Home

Properties

- For lamps, fans, household appliances, coffee machines, home entertainment and other devices
- Can be used also as a night light
- Thanks to Plug-Control, the devices can be integrated into scenes and automatic sequences and switched on and off via Yubii Home
- Also useful if the socket is difficult to access (switched on and off with the app)
- Visualisation of the power consumption by coloured crystal LED ring (microprocessor-controlled)
- History and statistics on power consumption can be visualised via Yubii Home
- Extremely compact and can be remote controlled
- Supports the following Z-Wave network security mode:
 - S0 with AES-128 encryption

	Plug-Control
Item number	3094 0383 0301

Technical data	
Power supply (V AC)	230V AC 50/60 Hz
Rated operating output voltage (A)	11
Power consumption (W)	up to 1.6
Output power for resistive loads (kW)	2.5
Conformity to standards	RED 2014/53/EU RoHS 2011/65/EU
Ambient operating temperature (°C)	0 to +40
Compatible with type F sockets (Schuko)	CEE 7/16 (max. load of 2.5 A) CEE 7/17 (max. load of 11 A) Double plug F
Radio transmission power (dBm)	up to -10 (EIRP)
Radio protocol	Z-Wave
Radio frequency (MHz)	868.4 or 869.8 (EU)
Range (m)	Up to 50 outdoors Up to 30 in buildings (depending on the terrain and building structure)
Dimensions Ø x H(mm)	43 x 65



For loads other than resistive loads, please observe $\cos \phi$ and use a lower load than the nominal load if necessary. It is not recommended to exceed 3 A for 250 V AC, $\cos \phi=0,4$.

Push-Control

Switches for electrical appliances and scenes



The practical scene switch Push-Control switches electrical appliances on and off and, in connection with Yubii Home, is able to trigger scenes. Up to six different actions or scenes can be carried out with Push-Control. In panic mode, each press of the button triggers the emergency scene. Thanks to its small design and wireless communication, the Push-Control can be conveniently placed on any surface and mounted in any position, e.g. next to the bed or under the desk.

Push-Control	white	black	red
Item number	3016 1684 0301	3016 1674 0301	3016 1664 0301

Technical data

Battery type	ER14250 ½AA, 3.6V DC (included in scope of delivery)		
Rechargeable battery life	Approx. 2 years (with default settings and max. 10 operations/day)		
Ambient operating temperature (°C)	0 to +40		
Radio protocol	Z-Wave (500 series chip)		
Radio transmission power (dBm)	up to 1 (EIRP)		
Radio frequency	868.4 or 869.8 (EU)		
Conformity to standards	RED 2014/53/EU RoHS 2011/65/EU		
Range (m)	Up to 50 outdoors Up to 40 in buildings (depending on the terrain and building structure)		
Dimensions Ø x H (mm)	46 x 34		
Colour	white	black	red

Included in this kit¹:



works with
Yubii® Home

Properties

- Switch for six actions (one to five clicks and hold)
- Integrated in Yubii Home, scenes can be triggered and messages sent to a smart phone, for example
- Can be used as a panic button
- Supports the following Z-Wave network security mode:
 - S0 with AES-128 encryption
- Wireless, battery-operated Z-Wave communication
- Can be installed in any position in your house
- Can be placed on surfaces without mounting
- Easy start-up via Yubii Home
- Three colour variants (white, black, red)

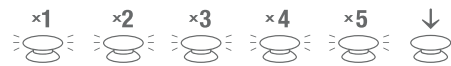

Several clicks activate different created scenes.

Available in these colours



¹ only available in white in the living comfort kit

The home becomes smart

Centero Home NXT is the ideal introduction to the Smart Home world. The monitoring, control and automation of home automation products is possible by radio control (868 MHz, 433 MHz), IP and infrared. Centero Home NXT can be used both in the cloud and locally in a WLAN. All functions related to sun protection and roller shutter control are covered. In addition, home automation and security components as well as lifestyle products from other manufacturers can be integrated.



Centero Home NXT

Central home automation from elero –
Smart control for increased living comfort.



All functions relating to sun shading and roller shutter control are covered. In addition, home technology and security components as well as various lifestyle products from other manufacturers can also be integrated.

Centero Home NXT	
Item no.	28 806.0001
Technical data	
Rated voltage (V)	5 DC / 1,5 A
Power consumption (W)	1.3
Ambient operating temperature (°C)	0 to +40
Radio frequency (MHz)	433 / 868
Dimensions L x B x H (mm)	110 x 110 x 32
Network	WLAN IEEE 802.11 /b/g/n, 2.4 GHz
Radio transmission range (m)	> 100 (free field)
Radio transceiver	1 x transceiver for 433 MHz & 1 x transceiver for 868 MHz &
Infra red (IR)	Integrated 38 KHz IR receiver and transmitter unit (36 – 455 KHz)
Connections for External IR transmitter	2 x 3.5 mm jack socket, addressable (rear)
IR to radio connector	Triggering a radio command by means of IR remote control
RGB LED Indicator (top side)	Programmable, for device status display
Bidirectional radio (868 MHz)	•
Learning functionality	Radio and IR
Product contents	Centero Home Gateway, mains plug

Properties

- Simple and intuitive operation of home technology by smartphone or tablet
- Locally in the WLAN and remotely via the cloud
- Für mehr Sicherheit und Energieeffizienz
- Controllable with Centero Home NXT:
 - Complete privacy and sun protection with elero radio drives and receivers
 - Radio-controlled socket outlets, lighting and heating elements with elero radio receivers
 - Motion and smoke detectors, window contacts, radiator thermostats and temperature sensors from Homematic
 - Lighting systems from Philips Hue
 - Simple commissioning by specialised tradesman possible without access to the customer's WLAN
 - Calendar function, daily schedules, manual/automatic switchover, scene control, display of critical devices, favourites, action lists, use of different configurations per user, optional cloud backup
 - In-app upgrade to the Centero Home Plus version:
 - Amazon Alexa voice control
 - Integration of Sonos sound systems
 - Integration of Netatmo weather stations
 - Visitor management with Doorbird door intercoms



For a complete list of Centero Home NXT compatible control systems and devices, visit www.elero.com/centerohome

elero

Hand-held radio transmitters

VarioSon-868 Slide	174.
LumeroSon-868 / Slide	174.
LumeroSon-868 Mini	175.
MonoSon-868 Mini	175.
VarioCom / Slide	176.
LumeroCom	176.
MonoCom / Slide	176.
TempoTel 2	178.
MultiTel 2	178.
VarioTel 2	178.
LumeroTel 2	179.
MonoTel 2	179.

Hand-held
radio transmitters

Solar drives systems
Speciality drives

Venetian Blind drives

RevoLine
L RH / L NHK

RevoLine
S + M

Hand-held radio transmitters



Radio technology for roller shutters, awnings, roller blinds and venetian blinds bring more convenience to your own four walls. With a hand-held radio transmitter from elero, roller shutters, awnings and much more can be controlled very conveniently, for example from your sofa, bed or anywhere else in your house.

The hand-held radio transmitters impress with their modern design and their ergonomic, user-friendly construction. Your specialist can carry out the installation of the control components at any time without any dirt and time-consuming assembly.

Bidirectional routing with ProLine 2



ProLine 2, the bidirectional radio system from elero, is more reliable, powerful and transparent than unidirectional radio standards. At the heart of the technology (868 MHz) are bidirectional radio components

(transceivers) that are capable not only of receiving, but also of confirming and relaying the signals. As soon as a command has been executed on the drive, the user receives feedback and can be sure that the commands are being executed correctly.

Application areas

The hand-held radio transmitters from elero offer an ideal control solution for dedicated drive technology, such as roller shutters, sun protection systems and doors, as well as for heating systems, lighting installations or other electrical consumers. Operation of one or more applications is carried out simply at the touch of a button or is completely automated.

	Vario-Son-868 Slide	Lumero-Son-868 / Slide	Lumero-Son-868 Mini	Mono-Son-868 Mini	Vario-Com / Slide	Lumero-Com	Mono-Com / Slide	Tempo-Tel 2	MultiTel 2 VarioTel 2	Lumero-Tel 2	Mono-Tel 2
Page	174	174	175	176	176	176	178	178	178	179	179
Roller shutters / interior shading	•	•	•	•	•	•	◦	•	•	•	•
Awnings / ZIP / exterior shading	◦	•	•	◦	•	•	◦	◦	•	•	◦
Venetian blinds	•	•	•	◦	•	•	◦	•	•	•	◦
Lighting	•	•	•	•	•	•	•	•	•	•	•
Heating	◦	•	•	•	•	•	•	◦	•	•	•

◦ Partial fulfilment • Complete fulfilment

TOP functions

With elero control systems, roller shutters, venetian blinds or patio awnings can be operated easily and conveniently. And with ProLine 2, the bidirectional radio system from elero, this can be done even more reliably, efficiently and transparently.

	Vario-Son-868 Slide	Lumero-Son-868 / Slide	Lumero-Son-868 Mini	VarioCom / Slide	Lumero Com	MonoCom / Slide	Tempo-Tel 2	Multi-Tel 2	Vario-Tel 2	Lumero-Tel 2	Mono-Tel 2
Page	174	174	175	176	176	176	178	178	178	179	179
Radio transmitter, number of channels	6	1	1	6	1	1	10	15	5	1	1
Central channel	• ³			• ³			•	•	•		
Group channels	• ³			• ³			2	5			
Manual/auto switchover/display	•	•	•	•	•		•	•	•	•	
Integrated buttons	•	•	•	•	•	•	•	•	•	•	•
Integrated slider ¹	•	•		• ⁴		• ⁴					
Colour variants available	•	•	•				•	•	•	•	•
LCD display							•	•			
LED channel display	•			•					•		
Position display							•	•			
Astro functionality ²							•				
Multiple languages selectable							•	•			
Intermediate/ventilation position	•	•	•	•	•	•	•	•	•	•	•
Turning position / fabric tautening	•	•	•	•	•	•	•	•	•	•	•
Bidirectional transmitter/receiver*	•	•	•	•	•	•	•	•	•	•	•
Unidirectional transmitter/receiver							•		•	•	•
Incl. wall bracket and batteries	•	•	•	•	•	•	•	•	•	•	•

◦ Partial fulfilment • Complete fulfilment * incl. autom. routing function

¹ Slider function allows easy dimming or slow travel with compatible devices

² Astro, sunrise and sunset (or weekly switching time), Astro shift (adjustable), city selection (156), longitude/latitude setting, time zone, weekly switching time (1x UP and 1x DOWN per day) and second weekly switching time (when using the Astro function, only one switching time per day; group and central channel also both offer one or two switching times), holiday programme, assignment of position downward/upward approach, automatic summer/winter time switchover

³ Groups can be put together according to need

⁴ Only Slider versions

RevoLine
S + M

RevoLine
L RH / L NHK

Venetian Blind drives
L RH / L NHK

Solar drives systems
Speciality drives

Hand-held
radio transmitters

VarioSon-868 Slide / LumeroSon-868 (Slide)

ProLine 2 hand-held radio transmitter



VarioSon-868 Slide



LumeroSon-868 Slide



LumeroSon-868



VarioSon-868 Slide

- 6-channel hand-held transmitter with slider
- Manual/automatic mode switchover

LumeroSon Slide

- 1-channel hand-held transmitter with slider
- Manual/automatic mode switchover

LumeroSon

- 1-channel hand-held transmitter
- Manual/automatic mode switchover

	VarioSon-868 Slide silver	LumeroSon-868 Slide silver	LumeroSon-868 silver
Item no.	28 703.0001	28 702.0001	28 701.0001

	VarioSon-868 Slide white	LumeroSon-868 Slide white	LumeroSon-868 white
Item no.	28 713.0001	28 712.0001	28 711.0001

Technical data

Rated voltage (V DC)	1.5	1.5	1.5
Battery type	2 x Micro LR03 (AAA)	2 x Micro LR03 (AAA)	2 x Micro LR03 (AAA)
Ingress protection (IP)	20	20	20
Ambient operating temperature (°C)	0 to +50	0 to +50	0 to +50
Radio frequency (MHz)	868	868	868
Dimensions L x B x H (mm) hand-held	155 x 43 x 21	155 x 43 x 21	155 x 43 x 21
Weight (g) incl. battery	81	81	81
Single channels	6	1	1
Group channels	1	-	-
Central channel	1	1	-
Manual/auto switching	•	•	•
Slider function	•	•	-
Bidirectional radio	•	•	•
Standard scope of delivery	incl. wall bracket, mounting set, 2 inserted batteries, operating instructions		

LumeroSon-868 Mini / MonoSon-868 Mini

ProLine 2 hand-held radio transmitter compact



LumeroSon-868 Mini

- 1-channel hand-held transmitter in compact form
- Manual/automatic mode switchover

MonoSon-868 Mini

- 1-channel hand-held transmitter in compact form

	LumeroSon-868 Mini silver	MonoSon-868 Mini silver
Item no.	28 722.0001	28 721.0001

	LumeroSon-868 Mini white	MonoSon-868 Mini white
Item no.	28 732.0001	28 731.0001

Technical data

	LumeroSon-868 Mini silver	MonoSon-868 Mini silver
Rated voltage (V DC)	3	3
Battery type	1 x CR2450 Lithium	1 x CR2450 Lithium
Ingress protection (IP)	20	20
Ambient operating temperature (°C)	0 to +50	0 to +50
Radio frequency (MHz)	868	868
Dimensions L x B x H (mm) hand-held	40 x 71 x 10	40 x 71 x 10
Weight (g) incl. battery	27	27
Single channels	1	1
Group channels	1	1
Central channel	1	1
Manual/auto switching	•	-
Bidirectional radio	•	•
Standard scope of delivery	incl. wall bracket, mounting set, 2 inserted batteries, operating instructions	

VarioCom (Slide) / LumeroCom / MonoCom (Slide)

ProLine 2 radio hand-held transmitter



VarioCom Slide

- 6-channel hand-held transmitter with slider
- Manual/automatic mode switchover

VarioCom

- 6-channel hand-held transmitter
- Manual/automatic mode switchover

LumeroCom

- Single-channel hand-held transmitter
- Manual/automatic mode switchover

MonoCom Slide

- Single-channel hand-held transmitter with slider

MonoCom

- Single-channel hand-held transmitter

	VarioCom Slide	VarioCom	LumeroCom	MonoCom Slide	MonoCom
Item no.	28 455.0002	28 445.0002	28 425.0002	28 435.0002	28 405.0002

Technical data

	VarioCom Slide	VarioCom	LumeroCom	MonoCom Slide	MonoCom
Rated voltage (V DC)	3	3	3	3	3
Battery type	2 x Micro LR03 (AAA)	2 x Micro LR03 (AAA)	2 x Micro LR03 (AAA)	2 x Micro LR03 (AAA)	2 x Micro LR03 (AAA)
Ingress protection (IP)	20	20	20	20	20
Ambient operating temperature (°C)	0 to +50	0 to +50	0 to +50	0 to +50	0 to +50
Radio frequency (MHz)	868	868	868	868	868
Dimensions L x W x H (mm) of hand-held transmitter	151 x 49 x 15	151 x 49 x 15	151 x 49 x 15	151 x 49 x 15	151 x 49 x 15
Weight (g) incl. battery	90	90	90	90	90
Individual channels	6	6	1	1	1
Group channels	1	1	–	–	–
Central channel	1	1	–	–	–
Manual/automatic switchover	•	•	•	–	–
Slider function	•	–	–	•	–
Bidirectional radio control	•	•	•	•	•
Standard scope of delivery	Incl. wall bracket, mounting set, 2 batteries inserted, operating instructions				

Design and functionality



The bidirectional COM hand-held transmitters impress with their modern design and their ergonomic, user-friendly construction. Reliable feedback and reliable routing function with ProLine 2.

TempoTel 2 / MultiTel 2 / VarioTel 2

ProLine 2 radio hand-held transmitter



TempoTel 2

MultiTel 2

VarioTel 2



TempoTel 2

- 10 individual channels, 2 group channels + 1 central channel
- Integrated timer (bidirectional per channel, group, central)
- Individual, Astro evening or Astro switching times, adjustable
- Visualisation of transmission and feedback commands

MultiTel 2

- 15 individual channels, 5 group channels + 1 central channel
- Can be used only bidirectionally
- Positions and commands displayed on multi-line display

VarioTel 2

- 5 individual channels and 1 central channel
- Visualisation of transmission and feedback commands

Multi-channel hand-held transmitter, uni and bidirectional (except MultiTel 2)¹, reliable radio transmission frequency of 868 MHz, available in 3 colours (pure white, silver, titanium grey).

TempoTel 2 (language version 1*)

	pure white	silver	titanium grey	pure white	silver	titanium grey	pure white	silver	titanium grey
Item no.	28 265.0002	28 266.0002	28 267.0002	28 255.0001	28 256.0001	28 257.0001	28 245.0001	28 246.0001	28 247.0001

TempoTel 2 (language version 2*)

	pure white	silver	titanium grey
Item no.	28 465.0002	28 466.0002	28 467.0002

Technical data

	TempoTel 2 (language version 1*)	MultiTel 2	VarioTel 2
Rated voltage (V DC)	3	3	3
Battery type	2 x LR06 (AA Mignon)	2 x LR06 (AA Mignon)	2 x LR06 (AA Mignon)
Ingress protection (IP)	20	20	20
Ambient operating temperature (°C)	0 to +50	0 to +50	0 to +50
Radio frequency (MHz)	868	868	868
Dimensions L x W x H (mm) of hand-held transmitter	150 x 51 x 26	150 x 51 x 26	120 x 51 x 26
Weight (g) incl. battery	140	140	120
Individual channels	10	15	5
Group channels	2	5	-
Central channels	1	1	1
Manual/automatic switchover	•	•	•
Unidirectional radio control	•	-	•
Bidirectional radio control	•	•	•
Standard scope of delivery	Incl. batteries, magnetic wall bracket and mounting material (packed ready for installation in the sales box)		

*Language version 1: German, English, French, Spanish, Italian, Portuguese, Dutch, Swedish, Danish, Polish

*Language version 2: German, English, Hungarian, Czech, Slovenian, Turkish

¹TempoTel 2 and VarioTel 2 can be set to either uni or bidirectional mode; both modes at the same time is not possible on one channel

LumeroTel 2 / MonoTel 2

ProLine 2-Funkhandsender



LumeroTel 2

MonoTel 2



LumeroTel 2

- Can be used as individual, group or central transmitter
- Manual/automatic switchover
- Visualisation of transmission and feedback commands

MonoTel 2

- Can be used as individual, group or central transmitter
- Visualisation of transmission and feedback commands

Single-channel hand-held transmitter, uni or bidirectional¹, available in 3 colours, reliable radio transmission frequency of 868 MHz.

Item no.	LumeroTel 2			MonoTel 2		
	pure white	silver	titanium grey	pure white	silver	titanium grey
	28 225.0001	28 226.0001	28 227.0001	28 205.0001	28 206.0001	28 207.0001

Technical data		
Rated voltage (V DC)	3	
Battery type	2 x LR06 (AA Mignon)	
Ingress protection (IP)	20	
Ambient operating temperature (°C)	0 to +55	
Radio frequency (MHz)	868	
Dimensions L x W x H (mm) of hand-held transmitter	120 x 51 x 26	
Weight (g), incl. battery	120	
Channels	1	
Manual/automatic switchover	•	
Unidirectional radio control	•	
Bidirectional radio control	•	
Standard scope of delivery	Incl. batteries, magnetic wall bracket and mounting material (packed ready for installation in the sales box)	

¹ LumeroTel 2 und MonoTel 2 can be set to either uni or bidirectional mode; both modes is not possible at the same time on one channel

elero

Radio transmitters

VarioSon W-868	184.
LumeroSon W-868	185.
MonoSon W-868	185.
AstroTec-868 / bidi	186.
MonoTec-868	187.
QuinTec-868	187.
Invio-868	188.
UniTec-868	189.

Radio transmitters



Increase your living comfort with radio transmitters from elero, which can be installed at the desired location independently of the mains supply. The range includes single-channel and multi-channel radio wall transmitters as well as modules for subsequent automation.

This allows, among other things, sun protection systems to be operated either manually, on demand or automatically by means of e.g. time and Astro programmes.

Bidirectional routing with ProLine 2



ProLine 2, the bidirectional radio system from elero, is more reliable, powerful and transparent than unidirectional radio standards. At the heart of the technology (868 MHz) are bidirectional radio components

(transceivers) that are capable not only of receiving, but also of confirming and relaying the signals. As soon as a command has been executed on the drive, the user receives feedback and can be sure that the commands are being executed correctly.

Application areas

elero offer a wide range of radio transmitters that can be used in a variety of applications. In addition to controlling roller shutters, sun protection systems and doors, it is also possible to integrate heating systems, lighting installations and many other electrical applications.

	VarioSon W-868	LumeroSon W-868	MonoSon W-868	AstroTec -868 /bidi	MonoTec -868	QuinTec -868	Invio-868	UniTec-868 UniClic-868
Page	184	185	185	186	187	187	188	189
Roller shutters / interior shading	•	•	•	•	•	•	•	•
Awnings / ZIP / exterior shading	•	•	◦	◦	◦	•	◦	•
Venetian blinds	•	•	◦	•	◦	•	◦	•
Lighting	•	•	•	•	•	•	•	•
Heating	•	•	•	◦	•	•	•	•

◦ Partial fulfilment • Complete fulfilment

TOP functions

Wall transmitters and timers with manual/automatic switchover as well as built-in radio transmitters for subsequent automation simplify the operation of domestic sun protection systems.

	VarioSon W-868	LumeroSon W-868	MonoSon W-868	AstroTec -868 /bidi	MonoTec -868	QuinTec -868	Invio-868	UniTec-868 UniClic-868
Page	184	185	185	186	187	187	188	189
Radio transmitter, number of channels	6	1	1	1	1	5	1	1
230V connection required							•	
Ext. inputs / building management system / integration of audiovisual systems (230V)							•	
Manual/automatic switchover	•	•		•		•		•
Integrated buttons	•	•	•	•	•	•		•
Astro, sunset (or weekly switching time)				•				
Astro, sunrise (or weekly switching time)				•				
Astro shift (adjustable)				•				
City selection (156)				•				
Longitude / latitude setting				•				
Weekly switching time (1x UP and 1x DOWN per day)				•				
2nd weekly switching time (1x UP and 1x DOWN per day)				•				
Offset (subsequent closing command)				•				
Light sensor that can be connected / twilight function				•				
Light sensor function				•				
Multiple languages selectable				•				
Intermediate/ventilation position				•	•	•	•	•
Turning position/fabric tautening				•	•	•	•	•
Holiday program				•				
Assignment of downward position approach				•				
Autom. summer/winter time changeover				•				
Run time setting				•				
Non-erasable memory for date of initial commissioning, relay switching frequency, total runtime				•				
Bidirectional transmitter	•	•	•	• ⁺	•	•	•	•
Unidirectional transmitter				• [“]			•	•

◦ Partial fulfilment • Complete fulfilment

* Times for 2 groups + central

+ only AstroTec-868 bidi

" only AstroTec-868

VarioSon W-868

6-channel wall-mounted radio transmitter with manual-automatic switchover



Elegant 6-channel radio wall transmitter.

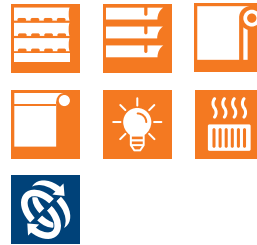

VarioSon W-868

- 6-channel wall-mounted radio transmitter
- Transmission and feedback commands are visualised
- Switchover between automatic and manual operation possible
- Only bidirectional
- Suitable for standard device inserts 50 x 50 mm and can be combined with standard switch programs
- Transmission-safe radio frequency 868 MHz
- Available in white and silver versions
- Frame and mounting bracket included in the scope of delivery

VarioSon W-868	silver	white
Item number	28 663.0001	28 673.0001

Technical data

Rated voltage (V DC)	3	3
Battery type	1 x CR2450 Lithium	1 x CR2450 Lithium
Protection class (IP)	20	20
Ambient operating temperature (°C)	0 to +50	0 to +50
Radio frequency (MHz)	868	868
Dimensions L x W x D (mm) without frame	50 x 50 x 10	50 x 50 x 10
Type of mounting	Wall mounting (surface mounting)	
Bidirectional radio control	•	•
Colour selection	silver	white
Standard scope of delivery	incl. frame + mounting plate	

Compatible accessories	Frame silver
Item number	28 661.0101

	Frame white
Item number	28 671.0101

	Mounting plate black (5 Pcs.)
Item number	28 599.0001

LumeroSon W-868 / MonoSon W-868

Single-channel wall-mounted radio transmitter



LumeroSon W-868



MonoSon W-868

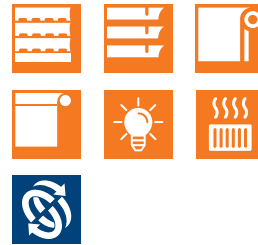

1-channel wall-mounted radio transmitter.

LumeroSon W-868

- 1-channel radio wall transmitter
- Visualization of transmission and feedback commands
- Manual/automatic switching possible
- Bidirectional only
- Suitable for standard device insert 50 x 50 mm and can be combined with standard switch programs
- Transmission-safe radio frequency 868 MHz
- Available in white and silver versions
- Frame and mounting bracket included in the scope of delivery

MonoSon W-868

- 1-channel radio wall transmitter
- Visualization of transmission and feedback commands
- Bidirectional only
- Suitable for standard device insert 50 x 50 mm and can be combined with standard switch programs
- Transmission-safe radio frequency 868 MHz
- Available in white and silver versions
- Frame and mounting bracket included in the scope of delivery

	LumeroSon W-868		MonoSon W-868	
	silver	white	silver	white
Item number	28 662.0001	28 672.0001	28 661.0001	28 671.0001

Technical data

	LumeroSon W-868		MonoSon W-868	
	silver	white	silver	white
Rated voltage (V DC)	3		3	
Battery type	1 x CR2450 Lithium		1 x CR2450 Lithium	
Protection class (IP)	20		20	
Ambient operating temperature (°C)	0 to +50		0 to +50	
Radio frequency (MHz)	868		868	
Dimensions L x W x D (mm) without frame	50 x 50 x 10		50 x 50 x 10	
Type of mounting	Wall mounting (surface mounting)			
Bidirectional radio control	•		•	
Colour selection	silver	white	silver	white
Standard scope of delivery	incl. frame + mounting plate			

Compatible accessories

	Frame silver
Item number	28 661.0101

Frame white

Item number	28 671.0101
-------------	-------------

Mounting plate black (5 Pcs.)

Item number	28 599.0001
-------------	-------------

AstroTec-868 / AstroTec-868 bidi

Radio timers



AstroTec-868/AstroTec-868 bidi

- Integrated timer
- Individual, group or central control unit
- Uni or bidirectional (depending on version)
- Individual, Astro evening or Astro switching times adjustable
- Connectable light sensor
- 868 MHz radio frequency for reliable transmission
- Manual/automatic switchover possible

Convenient single-channel timer with Astro programme, radio frequency of 868 MHz for reliable transmission.

	AstroTec-868	AstroTec-868 bidi
Item number	28 320.0001	28 320.0006

Technical data

Rated voltage (V DC)	3	3
Battery type	2 x LR 03 (AAA)	2 x LR 03 (AAA)
Protection class (IP)	20	20
Ambient operating temperature (°C)	0 to +55	0 to +55
Radio frequency (MHz)	868	868
Dimensions L x W x D (mm)	85 x 85 x 28	85 x 85 x 28
Type of mounting	Wall mounting (surface mounting)	
Unidirectional radio control	•	–
Bidirectional radio control	–	•
Colour selection	alpine white	alpine white
Standard scope of delivery	Batteries, wall bracket, 2 wall plugs (Ø 6 mm), 2 screws (Spax 4 x 35)	

Compatible accessories Lumo 2.0 m (p. 228)

Item number	28 080.0001
-------------	-------------

Lumo 10.0 m (p. 228)

Item number	28 090.0001
-------------	-------------

Note

¹ The AstroTec-868 bidi is a radio wall transmitter for exclusive use with bidirectional receivers (it is not possible to use the AstroTec-868 bidi with unidirectional receivers; in this case, the AstroTec-868 (item no.: 28 320.0001) must be used!

Accessories and components

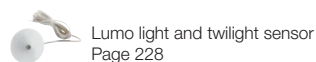

MonoTec-868

Single-channel radio wall transmitter



1 channel for the operation of roller shutters, venetian blinds and awnings. For 50 x 50 standard switch ranges.

Properties

- Single-channel wall transmitter
- 868 MHz radio frequency for reliable transmission
- Suitable for standard device deployment 50 x 50 mm
- UP, STOP, DOWN/CLOSED push button, P programming button (rear)
- Status LED for indication of system statuses

MonoTec-868	
Item number	28 650.0002

Technical data	
Power supply (V)	3 V Battery CR 2032
Radio frequency (MHz)	868
Number of channels	1 (bidirectional)
Ambient operating temperature [°C]	0 to +50
Protection class (IP)	20
Protection class (following professional assembly)	II
Type of mounting	Wall mounting

QuinTec-868

5-channel radio wall transmitter



5 single channels and 1 central channel for the operation of roller shutters, venetian blinds and awnings. For 50 x 50 standard switch ranges.

Properties

- 5 individual channels and 1 central channel
- 868 MHz radio frequency for reliable transmission
- Suitable for standard device deployment, 50 x 50 mm
- Manual/automatic mode switchover
- Status LED for indication of system statuses

QuinTec-868	
Item number	28 655.0002

Technical data	
Power supply (V)	3 V Battery CR 2032
Radio frequency (MHz)	868
Number of channels	5 + 1 (bidirectional)
Ambient operating temperature [°C]	0 to +50
Protection class (IP)	20
Protection class (following professional assembly)	II
Type of mounting	Wall mounting

Invio-868

Built-in radio transmitter



The radio transmitter for all elero radio receivers of the ProLine series.

Invio-868	
Item number	28 380.0006

Technical data

Rated voltage (V)	1 ~ 230 – 240
Rated frequency (Hz)	50 – 60
Protection class (IP)	20
Channels	1
Ambient operating temperature (°C)	0 to +55
Radio frequency (MHz)	868
Dimensions L x W x H (mm)	52 x 48 x 27
Weight	43
Type of mounting	Flush mounted, Ø 58 mm wall installation, surface mounted in corresponding housing
Unidirectional radio control	•
Bidirectional radio control	•

Properties

- Suitable for the subsequent automation of roller shutters, awnings or venetian blinds
- Suitable for all elero radio receivers of the ProLine series
- Forwarding of higher-level, wired control commands
- Can be controlled by conventional venetian blind push buttons
- 868 MHz radio frequency for reliable transmission
- Uni and bidirectional
- Potential-free input for Up/Down

UniTec-868 / UniClic-868

Radio wall transmitter with manual/automatic switchover



UniTec-868

UniClic-868



Properties UniTec-868

- Single-channel wall transmitter
- Uni or bidirectional
- For controlling one or more receivers
- Manual/automatic switchover
- 868 MHz radio frequency for reliable transmission

Properties UniClic-868

- Single-channel wall transmitter
- Uni or bidirectional
- For controlling one or more receivers
- Manual/automatic switchover
- 868 MHz radio frequency for reliable transmission
- Frame height of 215 mm
- Suitable for existing, conventional belt winding boxes

Convenient single-channel wall transmitter for controlling one or more receivers.

	UniTec-868	UniClic-868
Item number	28 330.0007	28 882.0006

Technical data

Rated voltage (V DC)	3	3
Battery type	CR 2032	CR 2032
Protection class (IP)	20	20
Ambient operating temperature (°C)	0 to +50	0 to +50
Radio frequency (MHz)	868	868
Dimensions L x W x D (mm)	54 x 54 x 22 (without frame) 81 x 81 x 22 (with frame)	215 x 64 x 49 (with frame)
Type of mounting	Wall construction	Belt case
Channels	1	1
Manual/automatic switchover	•	•
Unidirectional radio control	•	•
Bidirectional radio control	•	•
Colour selection	alpine white	alpine white
Standard scope of delivery	ProLine frame, wall bracket, battery, 2 wall plugs (Ø 6 mm) and 2 screws (4 x 35)	UniClic frame and battery

Accessories and components



elero

Radio receivers

VarioTec-868	194.
Unio-868	195.
Revio-868 /P /SW	196.
AeroControl-868	197.
Combio-868 JA /Pulse /RM	198.
Combio-868 HE /LI	199.
Combio-868 LI-D	201.

Radio receivers



Radio receivers enable flexible and automatic control of numerous devices. The extensive range from elero offers the right solution for everyone – whether integrated in

the radio transmitter or for retrofitting a wired wall transmitter. Increase your living comfort and security and use the full possibilities of an automated home.

Bidirectional routing with ProLine 2



ProLine 2, the bidirectional radio system from elero, is more reliable, powerful and transparent than unidirectional radio standards. At the heart of the technology (868 MHz) are bidirectional radio components

(transceivers) that are capable not only of receiving, but also of confirming and relaying the signals. As soon as a command has been executed on the drive, the user receives feedback and can be sure that the commands are being executed correctly.

Application areas

elero offer numerous control solutions. Both for dedicated drive technology, such as roller shutters, sun protection systems and doors, as well as for heating systems, lighting installations or other electrical consumers. Regardless of whether wired or radio-controlled – operation is very simple at the touch of a button or completely automated.

	VarioTec -868	Unio -868	Revio -868	Revio -868 P	Revio -868 SW	Aero- Control -868	JA	JA Pulse	Combio-868			
									RM	HE	LI	LI-D
Page	194	195	196	196	196	197	198	198	198	199	199	201
Roller shutters / interior shading	•		•	•	•				•			
Awnings / exterior shading	•		•	•	•	•			•			
Venetian blinds	•		•	•	•	•	•	•				
Lighting		•			•						•	•
Heating		•								•		

TOP functions

Radio receivers from elero enable flexible automation while ensuring a high level of transmission reliability. With the appropriate components, floor lamps, radiant heaters, lighting and much more can be conveniently integrated into your home automation system and their devices can be controlled conveniently and reliably.

	Vario-Tec -868	Unio -868	Revio -868	Revio -868 P	Revio -868 SW	Aero-Control -868	Combio-868					
							JA	JA Pulse	RM	HE	LI	LI-D
Page	194	195	196	196	196	197	198	198	198	199	199	201
Switching of mains voltage (230 V)	•	•	•	•	•	•	•	•	•	•	•	
Switching of low voltage (< 6 V)	•			•	•							
230 V connection necessary	•	•	•	•	•	•	•	•	•	•	•	
Running modes ¹	RM, JA	SW	RM, JA, PU	RM, JA, PU, GR	RM, JA, SW	RM	JA	PU	RM	HE	LI/SW	
External entrances / building management system/ integration of audiovisual systems	•		•		•	•						
Manual/automatic switchover	•											
Integrated buttons	•	•										
Connectable push button	•		•		•	•						
Connectable light sensor / twilight function						•						
Light sensor function						•						
Connectable wind sensor / wind sensor function						•						
Re-extension after wind						•						
Intermediate & ventilation position	•		•	•	•	•	•	•	•			
Tilting position / fabric tautening	•		•	•	•	•	•	•	•			
Dimmer value can be stored											•	
Bidirectional transmitter/receiver incl. automatic routing function	•	•	•	•	•		•	•	•	•	•	•
Unidirectional transmitter/receiver	•	•	•	•	•	•	•	•	•	•	•	

¹ Running modes: RM (tubular drives)

– Immediate maintained mode, runtime of two minutes (Revio-SW: five minutes); 2 intermediate positions can be stored and approached by double-clicking (up/down button). If no positions are stored, the end positions are approached

JA (venetian blind drives)

– Dead man's mode, maintained mode after two seconds of pressing the button, runtime of three minutes (Revio SW 5 minutes); 2 intermediate positions can be stored. Double-click on the down button to move to the down position and then to the distance time for the up intermediate position. If you double-click on the up button, only the distance time is run in upward direction. If no positions are stored, the end positions are approached.

PU (pulsable drives)

– Defined, adjustable pulse time, maintained mode after two seconds of pressing the button, runtime of three minutes

GY

– Short pulse signals for controlling ProLine devices at low-voltage input
– Retrofitting of existing ProLine or WKS control systems to the current elero radio standard without removing the devices

SW (light control)

– Light switch function, runtime unlimited, until opposite direction or stop is activated

HE (heating function)

– Dimmability of 0, 33, 66 and 100% for radiant heaters; intermediate positions/stages are programmed to fixed values and can be deactivated; intermediate positions/stages can be approached or activated by double-clicking (up/down).

LI (light function)

– Dimmability from 0 to 100%; lowest level can be limited; two intermediate positions/stages can be freely programmed and approached or activated by double-clicking (up/down button). Intermediate positions/stages can be deactivated to maintain the device functionality as in SW mode

VarioTec-868

Motor, group or central control unit



Integrated radio receiver; can be used as individual, group or central control unit with manual/automatic switchover. Suitable for roller shutters, awnings, venetian blinds, interior roller blinds and ZipScreens. Dedicated mains unit available.



works with
Yubii Home

Features

- Bidirectional radio system with automatic routing function
- Bidirectional or unidirectional
- Also available without radio control as VarioTec (p. 218)
- At least one transmitter must be programmed before a sensor system can be taught

VarioTec-868	alpine white	Set alpine white
Item number	28 341.0006	28 340.0006

Technical data

Rated voltage (V)	1 ~ 230 – 240	
Rated frequency (Hz)	50 – 60	
Switching current (A)	5 (ohmic load)	
Running modes	RM, JA	
Protection class (IP)	20	
Protection class (following professional assembly)	II	
Ambient operating temperature (°C)	0 to +55	
Radio frequency (MHz)	868	
Unidirectional radio control	•	
Bidirectional radio control	•	
Includes ProLine frame	–	•
Colour selection	alpine white	Set alpine white
Type of mounting	Flush mounted Ø 58 mm, surface-mounted wall installation in corresponding surface-mounted housing	

Accessories and components



Adapter frame
Page 220



Surface-mounted boxes and frames
Page 221



Radio transmitters
From page 182

Unio-868

Radio-controlled socket



works with
Yubii Home

Features

- Visual display of the current switching status
- Manual operation possible
- Can be integrated into existing ProLine radio systems
- Expandable with light sensors for automatic control
- Bidirectional radio system with automatic routing function

For wireless switching of electrical, mains-operated devices.

Unio-868	
Item number	28 980.0007

Technical data	
Rated voltage (V)	1 ~ 230-240
Rated frequency (Hz)	50
Switching capacity (VA)	max. 2.300
Running mode	SW
Protection class (IP)	20
Ambient operating temperature (°C)	0 to +35
Radio frequency (MHz)	868
Unidirectional radio control	•
Bidirectional radio control	•
Dimensions L x W x H (mm)	110 x 60 x 40
Weight (g)	165

Accessories and components



Radio transmitters
From page 182



Wireless sensors
From page 204

Revio-868 /P /SW

Built-in radio receiver for tubular and venetian blind drives and electrical consumers

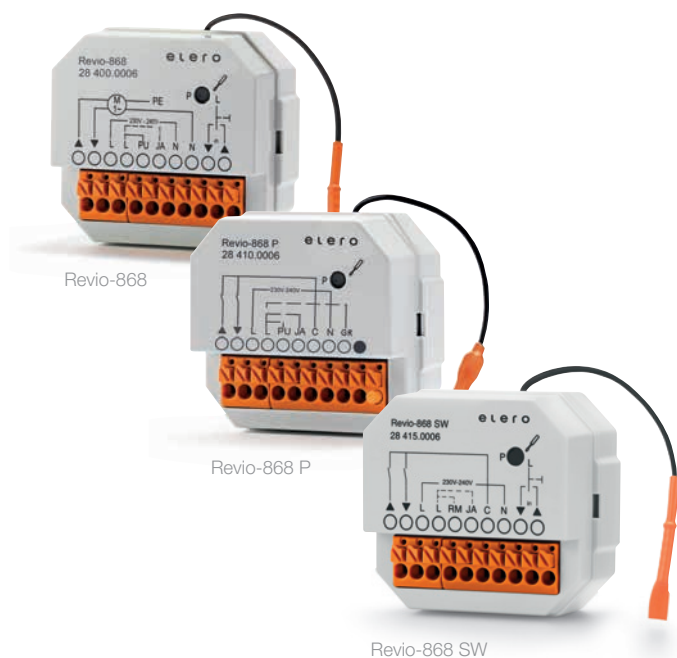

works with
Yubii Home

Revio-868

- Control of AC drives
- Can be controlled with all ProLine transmitters
- Venetian blind push button can be connected

Revio-868 P

- Relaying of signals to other automation systems
- Control of DC drives possible
- Potential-free output

Revio-868 SW

- Can be used with switchable, electrical consumers with 230 V AC supply voltage (e.g. light)
- Connectable venetian blind push button
- Potential-free output
- 5 minutes runtime for extra-high systems in RM and JA mode

Flush-mounted radio receiver for uni and bidirectional radio systems.

	Revio-868	Revio-868 P	Revio-868 SW
Item number	28 400.0006	28 410.0006	28 415.0006

Technical data			
Rated voltage (V)	1 ~ 230 – 240	1 ~ 230 – 240	1 ~ 230 – 240
Rated frequency (Hz)	50 – 60	50 – 60	50 – 60
Switching current (A)	3 (ohmic load)	3 (ohmic load)	3 (ohmic load)
Running modes	JA, PU, RM	JA, PU, RM, GR	JA, RM, SW
Protection class (IP)	20	20	20
Ambient operating temperature (°C)	0 to +55	0 to +55	0 to +55
Radio frequency (MHz)	868	868	868
Dimensions L x W x H (mm)	50 x 48 x 27	50 x 48 x 27	50 x 48 x 27
Weight (g)	52	52	52
Type of mounting	Flush mounted, Ø 58 mm, depth of 60 mm, surface mounted in corresponding surface-mounted housing		
Potential-free output	-	•	•
Unidirectional radio control	•	•	•
Bidirectional radio control	•	•	•
Group control	-	•	-
End position detection	•	-	-

Accessories and components



Radio transmitters
From page 182



Wireless sensors
From page 204

AeroControl-868

Control system for awnings and venetian blinds



Features

- 868 MHz radio receiver module
- Robust and simple design for easy retrofitting
- 868 MHz radio frequency for reliable transmission
- Operation with separate venetian blind push buttons or hand-held transmitter
- Connection options:
Aero, Ventero, Lumero, mains supply cable,
1 AC drive, venetian blind push button

Surface-mounted control system for sun protection systems with integrated radio receiver.

AeroControl-868	
Item number	28 370.0001

Technical data	
Rated voltage (V DC)	1 ~ 230
Rated frequency (Hz)	50 – 60
Switching current (A)	5 (ohmic load)
Running modes	RM, JA
Protection class (IP)	55
Ambient operating temperature (°C)	-25 to +50
Radio frequency (MHz)	868
Unidirectional radio control	•
Bidirectional radio control	–
Dimensions L x W x H (mm)	108 x 108 x 58
Weight (g)	272
Runtime (Min.)	2

Accessories and components	
	Interlocked push button Page 241
	Radio transmitters From page 182
	Lumero Page 228
	Aero Page 230

Combio-868 JA /Pulse /RM

Radio receivers for venetian blinds, roller shutters and textile sun protection



Combio-868 JA

Combio-868 RM-K STAS3/STAK3

Combio-868 RevoLine



works with **Yubii Home**

Combio-868 JA /Pulse

- For venetian blind drives
- Jog mode
- Adjustable intermediate and turning position
- Exact adjustment of the slats by pulse operation, pulse duration adjustable (only Combio-868 JA Pulse)

Combio-868 RevoLine RM

- For tubular drives
- Receiver immediately switches to maintained mode
- Intermediate position and ventilation position or fabric tautening can be set

All Combio-868s can be used in uni and bidirectional radio systems.

	Combio-868 JA	Combio-868 JA Pulse	Combio-868 RM (für NHK)	Combio-868 RevoLine	Combio-868 RM/STAK3	Combio-868 RM-K STAS3/STAK3
Item number	28 500.0006	28 505.0006	28 520.0006	28 525.0006	28 580.0006	28 585.0006

Technical data

Rated voltage (V)	1 ~ 230-240	1 ~ 230-240	1 ~ 230-240	1 ~ 230-240	1 ~ 230-240	1 ~ 230-240
Rated frequency (Hz)	50	50	50	50	50	50
Max. connected load (W)	450	450	450	450	450	450
Running modes	JA	PU	RM	RM	RM	RM
Protection class (IP)	56	56	56	56	56	56
Ambient operating temperature (°C)	-20 to +70	-20 to +70	-20 to +70	-20 to +70	-20 to +70	-20 to +70
Radio frequency (MHz)	868	868	868	868	868	868
Mains cable (m)	0.5 with Hirschmann plug STAS3		3	3	3	0.085 with Hirschmann plug STAS3
Motor cable (m)	0.25 with Hirschmann coupling STAK3		0.25 with Type 9 device connector	0.25 with RevoLine plug	0.25 with Hirschmann coupling STAK 3	0.095 with Hirschmann coupling STAK3
Dimensions LxWxH (mm)	100 x 40 x 15	100 x 40 x 15	100 x 40 x 15	100 x 40 x 15	100 x 40 x 15	100 x 40 x 15
Installation space L x W x H (mm)	104 x 44 x 19	104 x 44 x 19	104 x 44 x 19	104 x 44 x 19	104 x 44 x 19	104 x 44 x 19
Weight (g)	260	260	306	302	302	302
Standard pulse time (ms)	-	87.5	-	-	-	-

Compatible accessories		Fastening spring
Item number		16 302.3701
		Cable feedthrough
Item number		16 101.0101
		Cable fixing clip
Item number		13 707.5701

Accessories and components



Radio transmitters
From page 182

Wireless sensors
From page 204

¹Combio-868 JA in packaging of 10 is pre-programmed with end position detection and a turning position that can be overwritten.

Combio-868 HE /LI

Radio receiver for heating and lighting systems



Combio-868 HE

Combio-868 LI



works with
Yubii Home

Combio-868 HE

- Electric heating systems up to 2 kW
- Power can be switched on and off by radio control
- Heating system can be switched to 66 % power
- Bidirectional radio system (868 MHz)

Combio-868 LI

- Illuminant can be switched on and off by radio control
- Dimmability of illuminants
- 2 brightness levels selectable
- Lower dimming value can be set
- Can be set in SW mode to switch electrical consumers on and off by radio control
- Bidirectional radio system (868 MHz)
- Use of LEDs possible (after checking for compatibility)

	Combio-868 HE 2 kW	Combio-868 LI
Item number	28 594.0006	28 563.0006

Technical data

Rated voltage (V)	1 ~ 230-240	1 ~ 230-240
Rated frequency (Hz)	50	50
Maximum connected load (W)	2,000	100
Operating modes	HE	LI, SW
Protection class (IP)	56 (IP 54 plug connection)	56
Ambient operating temperature (°C)	-20 to +45	-20 to +65
Radio frequency (MHz)	868	868
Unidirectional radio control	•	•
Bidirectional radio control	•	•
Mains cable (m)	0.49 with Hirschmann plug STAS 3	3
Motor cable (m)	0.25 with Hirschmann coupling STAK 3	0.9
Dimensions LxWxH (mm)	147 x 48 x 29	100 x 40 x 15
Installation space LxWxH (mm)	151 x 52 x 33	104 x 44 x 19
Weight (g)	363	356

Compatible accessories	Connection cable set for Combio-868 HE 2 (6.5 m)
Item number	23 285.0901

Accessories and components

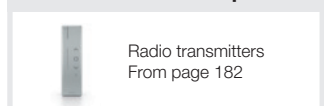

² With Hirschmann plug Stak 3 and earthed plug



Combio-868 LI-D W

Combio-868 LI-D RGBW

Dimmer with radio receiver for white LED strips, for a variety of installation situations



Combio-868 LI-D W
Combio-868 LI-D RGBW



Features

- Light source(s) can be switched on and dimmed with any elero radio control with 868 MHz
- A power supply unit and plug are required in addition to the Combio-868 LI-D RGBW
- Up to 30 transmitters can be taught in for each receiver
- Outputs can be controlled independently of each other
- Programming the Combio-868 LI-D radio receivers via radio transmitter

Combio-868 LI-D W

- Control of as many as 4 dimmable and cold/ warm white adjustable LED strips via two channels

Combio-868 LI-D RGBW

- Control of as many as 4 LED strips via one channel as well as the adjustment of their brightness and light colour

	Combio-868 LI-D W	Combio-868 LI-D RGBW
Item number	28 574.0001	28 575.0001

Technical data		
Voltage input (V DC)	24	24
Voltage output (V DC)	24	24
Connected load (W)	maximum load 100 per channel, maximum load 240	
Rated current light terminals (A)	max. 10	max. 10
Ingress protection (IP)	55	55
Protection class	II	II
Transmitter power (dBm)	≤ 10	≤ 10
Radio frequency (MHz)	868	868
Radio range (m)	up to 90 outdoors (depending on terrain structure)	
Ambient operating temperature (°C)	-20 to +45	-20 to +45
Weight (Kg)	0.15	0.15
Dimensions L x W x H (mm)	98 x 26 x 20	98 x 26 x 20
Type of mounting	loose	loose
Conformity	CE UK	

Accessories such as power supply units, LED strips, splitters and connectors can be found from the page 202.

Accessories and components

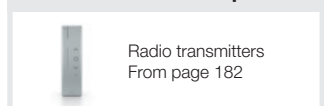

Radio transmitters
From page 182

Accessories for the Combio-868 LI-D radio receivers

Mains adapters

Suitable devices with compact dimensions are available to supply the Combio-868 LI-D dimmers with a 24 V power supply. The current is suited to the needs of the applications.



Item no.	Description	Quantity
590.010000	Mean Well mains adapter 100W 24 V constant power	1
590.015000	Mean Well mains adapter 150W 24 V constant power	1
590.032000	Mean Well mains adapter 320W 24 V constant power	1

Technical data

Item no.	590.010000	590.015000	590.032000
Output power (W)	100	150	312
Output voltage (V)	24	24	24
Output current (A)	4	6,3	13
Input voltage (V)	100 – 305 110/230 universal input	90 – 295 110/230 universal input	100 – 305 110/230 universal input
Protection class (IP)	67	65	67
Dimensions L x W x H (mm)	140x63x32	180x63x35,5	246x77x39,5
Dimming technology	Potentiometer	Potentiometer	Potentiometer
Casing type	Metal	Metal	Metal
RoHS	Compliant	Compliant	Compliant
Technology	AC/DC Constant current C.C. Constant power C.P.	AC/DC Constant current C.C. Constant power C.P.	AC/DC Constant current C.C. Constant power C.P.
Norm	LED EN 61347	LED EN 61347	LED EN 61347
Weight (kg)	0.58	0.8	1.87
Ambient operating temperature (°C)	-40 to +90	-40 to +85	-40 to +85
Conformity	CE	CE	CE

Plug connector

A plug connector is required to connect a Combio-868 LI-D device quickly and securely with a device for voltage supply.



Item no.	Description	Quantity
593.101001	KIT Mini Plug & Socket Connector 4p Screw D6-13.5 IP66/IP68 xDRY®	1

Accessories for the Combio-868 LI-D radio receivers

LED strips

Suitable LED strips are available for the various applications with adjustable white or RGBW and may be made up to meet your needs.



Artikelnummer	Description	Quantity
28 967.0001	LED strip RGBW IP67, 19.2 W/m, 5 m strip	1
28 968.0001	LED strip adjustable white, 17.3 W/m, 5 m strip	1

Technical data

Item no.	28 967.0001	28 968.0001
Operating voltage (V)	24	24
Operating current (A)	0.7 (1m) – 2.91 (5m)	0.625 (1m) – 2.5 (5m)
Power consumption (W)	16.8 (1m) – 69.84 (5m)	15.0 (1m) – 60.0 (5m)
Ingress protection (IP)	20/65	20/65
Ambient operating temperature (°C)	-25 to 40	-25 to 40
Size (mm)	5,000x 14x4.8	5,000x 10x1.5
Beam angle (°)	120	120
Number of LEDs per metre	60	140
Conformity	CE	CE

Splitter

The corresponding splitter is required to adapt LED strips for the Combio-868 LI devices. In addition, a splitter offers the possibility to connect as many as four LED strips to a Combio-868 LI device.



Item no.	Description	Quantity
28 976.0001	Cable splitter for RGBW LED strip	1
28 977.0001	Cable splitter for adjustable white LED strip	1

End caps

End caps seal the unused end connections of a splitter.



Item no.	Description	Quantity
593.102000	End cap for RGBW LED strip	1
28 979.0001	End cap for adjustable white LED strip	1

elero

Wireless sensors

Sensero-868 AC /Plus	208.
Aero-868 /Z /Plus /AC	209.
Protero-868	210.
Lumero-868	210.
Lumo-868	211.



Wireless sensors from elero enable weather-dependent operation of a wide range of applications in your home. No matter whether it is sunny, windy or rainy by

checking ambient values such as brightness, wind strength and humidity, your home reacts to changes in the weather at any time without you having to intervene.

Bidirectional routing with ProLine 2



ProLine 2, the bidirectional radio system from elero, is more reliable, powerful and transparent than unidirectional radio standards.

At the heart of the technology (868 MHz) are bidirectional radio components

(transceivers) that are capable not only of receiving, but also of confirming and relaying the signals. As soon as a command has been executed on the drive, the user receives feedback and can be sure that the commands are being executed correctly.

Application areas

Wireless sensors from elero make your home even more comfortable. The range of applications includes both the control of privacy and sun protection elements as well as the control of many other applications. Wireless sensors are also suitable for retrofitting existing applications. For example, awnings with a built-in radio receiver can be automated at a later date.

	Sensero -868 AC/ Plus	Aero/Z-868 Plus	Aero-868 Plus	Aero-868 AC	Aero -868	Protero -868	Lumero -868	Lumo -868
Page	208	209	209	209	209	210	210	211
Roller shutters / interior shading	◦	◦					•	◦
Awnings / exterior shading	•	•	•	•	•	•	•	◦
Venetian blinds	•	•	•	•			•	◦
ZIP systems		•	◦	◦	◦			

◦ Partial fulfilment • Complete fulfilment

TOP functions

With the help of wireless sensors, your applications react automatically to changes in the environment – without you having to intervene, even when you are not at home.

	Sensero -868 AC/ Plus	Aero/Z -868 Plus ¹	Aero-868 Plus	Aero-868 AC	Aero -868	Protero -868	Lumero -868	Lumo -868
Page	208	209	209	209	209	210	210	211
Radio transmitter, number of channels	1	1	1	1	1	1	1	1
230V connection required	•			•				
Manual/automatic switchover								◦
Integrated buttons	•	•	•	•	•	•	•	•
Twilight function	•							
Light sensor function	•	•	•	•	•		•	•
Glass breakage sensor function								•
Wind sensor function	•	•	•	•	•	•		
Bidirectional transmitter/ receiver incl. automatic routing function	•	•	•	•	•	•	•	•
Unidirectional transmitter/receiver	•	•	•	•	•	•	•	•

◦ Partial fulfilment • Complete fulfilment

¹ Extended wind range for wind-stable systems such as ZIP screens and stable venetian blinds

Sensero-868 AC /Plus

Wireless sensors for light, wind and rain

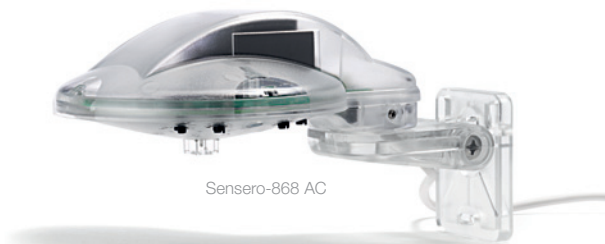

Sensero-868 AC

- Weather sensor with light, wind and twilight function
- Adjustable target values
- Pivoting wall bracket or mast support possible

Sensero-868 AC Plus

- With additional rain sensor

Targeted monitoring of sun protection systems.

230 V/50 Hz mains connection required. Can only be used in conjunction with compatible radio receivers from elero radio system. Manual operation of system with hand-held/wall transmitter.

	Sensero-868 AC	Sensero-868 AC Plus
Item number	28 890.0006	28 900.0006

Technical data

Rated voltage (V)	1 ~ 230-240	1 ~ 230-240
Rated frequency (Hz)	50 – 60	50 – 60
Protection class (IP)	44	44
Ambient operating temperature (°C)	-20 to +60	-20 to +60
Radio frequency (MHz)	868	868
Dimensions L x W x H (mm)	205 x 125 x 105	205 x 125 x 105
Weight (g)	600	610
Wind, light sensor	•	•
Rain sensor	–	•
Unidirectional radio control	•	•
Bidirectional radio control	•	•
Detection angle (°) of light or twilight sensor	150	150
Connection cable incl. (m)	5	5

Compatible accessories	Mast and corner mounting set (Ø 50 – 60 mm)
Item number	24 269.0202

Aero-868 /Z /Plus /AC

Solar and mains-powered wireless sensors for light and wind



Aero-868 Plus/Aero-868



Aero-868 /Plus /AC

- Aero-868: light and wind sensor for awnings
- Aero-868 Plus: light and wind sensor for awnings, venetian blinds and roller blinds. Additional solar and storage elements for extended standby time
- Aero-868 AC: light and wind sensor for awnings, venetian blinds and roller blinds with mains connection
- Aero-868 Z: for zip systems with higher set value for wind (km/h)

Wireless sensors for every situation.

	Aero/Z-868 Plus	Aero-868 Plus	Aero-868	Aero-868 AC
Item number	28 480.0016	28 480.0006	28 440.0006	28 460.0006

Technical data				
Power supply	solar	solar	solar	1 ~ 230-240
Protection class (IP)	43	43	43	43
Ambient operating temperature (°C)	-20 to +60	-20 to +60	-20 to +60	-20 to +60
Radio frequency (MHz)	868	868	868	868
Dimensions LxWxH (mm)	280 x 130 x 130	280 x 130 x 130	280 x 130 x 130	280 x 130 x 130
Detection angle (°) (light or twilight sensor)	150	150	150	150
Power reserve (h)	~24	~24	~12	-
Unidirectional radio control	•	•	•	•
Bidirectional radio control	•	•	•	•
Weight	380	380	380	360

Compatible accessories	Mast and corner mounting set (Ø 50 – 60 mm)
Item number	24 269.0202

Only in conjunction with compatible radio receivers from elero radio system. Manual operation of receivers with hand-held/wall transmitter possible. Radio frequency of 868 MHz for reliable transmission. Due to their limited power reserve, the Aero-868 is not suitable for sun protection systems with night-time privacy function!

Accessories and components



Radio receivers from Page 192

Protero-868

Wireless vibration sensor



Battery-powered, wireless vibration and inclination sensor for retractable arm awnings, adjustable wind sensitivity, water collection detection.

Features

- Automatic retraction of the awning in the event of vibrations or severe inclination
- Manual operation of the awning by hand-held/wall transmitter
- Can be combined only with receiver at the same awning
- Can be used only with radio receiver from the elero radio system ProLine 2 and ProLine-868
- In bidirectional radio operation, compatible with SunTop-868 radio tubular drives from vers. V25 and VariEco-868 from vers. V20 and the external radio receivers Combio-868 RM/Combio-868 RM Stak 3 from vers. V79 and Revio-868 from vers. V12

Protero	Traffic white	Traffic grey
Item number	28 965.0001	28 966.0001

Technical data	
Operating voltage (V)	3
Battery type	2 x LR03 (AAA)
Protection class (IP)	54
Ambient operating temperature (°C)	-20 to +60
Radio frequency (MHz)	868
Dimensions L x W x H (mm)	133,3 x 46,5 x 26,7
Colour selection	Traffic white Traffic grey
Weight inkl. Batterie (g)	186

Lumero-868

Solar-powered wireless light sensor



Wireless sun sensor with integrated solar cells.

Features

- Automatic travel to intermediate position or end position in automatic mode
- Manual operation of the system with hand-held/wall transmitter
- Can be used only with radio receiver from the elero radio system ProLine 2 and ProLine-868
- Uni and bidirectional. Bidi operation only possible for receivers from version 75 (Combio-868) or from version 21 (RoTop-868, SunTop-868) or from model year 05/12

Lumero-868	
Item number	28 680.0006

Technical data	
Power supply	solar
Protection class (IP)	54
Ambient operating temperature (°C)	-20 to +60
Radio frequency (MHz)	868
Detection angle (°)	190
Dimensions L x W x H (mm)	149,7 x 42 x 28
Weight inkl. Batterie (g)	75
Power reserve (h)	~1
Unidirectional radio control	•
Bidirectional radio control	•

Lumo-868

Wireless sensor



For light, twilight and glass breakage.

Features

- Automatic travel to bottom end position in the event of vibrations (glass breakage)
- Automatic travel to intermediate position or end position (automatic mode) in the event of intense solar radiation
- Wireless light, twilight and glass breakage sensor
- Adheres to glass with suction cup
- Manual operation with buttons possible
- UP, STOP/P, DOWN buttons
- Adjustable threshold values
- Uni and bidirectional: Bidi operation possible only with receivers from version 75 (Combio-868) or from version 21 (RoTop-868, SunTop-868) or from model year 05/12

Lumo-868	
Item number	28 420.0006

Technical data	
Rated voltage (V DC)	3
Battery type	CR 2032
Protection class (IP)	20
Ambient operating temperature (°C)	0 to +55
Dimensions Ø (mm)	48 x 15
Weight (g)	22
Radio frequency (MHz)	868
Unidirectional radio control	•
Bidirectional radio control	•
Standard scope of delivery	Battery, small screwdriver for adjusting both threshold controllers

Wall-mounted units wired

AstroTec	216.
TempoTec	217.
AstroClic	217.
AeroTec	218.
VarioTec	218.
TimeTec	219.
Adapter frames	220.
Frame and sockets	221.

Wired control units – Wall-mounted units



The control units of the ProLine generation open and close roller shutters and sun protection systems automatically by means of suitable wind and sun sensors (from page 226) or over time and offer you perfect living comfort. Technical perfection, high standards of quality and innovative design characterise these control systems.

They also offer straightforward operation, large push buttons and a clear display. A modular design of the individual control components allows for a wide variety of control options. Needless to say that the wall-mounted units are easy to connect and compatible with many standard switch ranges with the aid of an adapter frame.

Application areas

In addition to interior and exterior shading, the wall-mounted devices from elero can also be used to control lighting. With both wired and radio-controlled wall-mounted devices, a wide range of applications can thus be operated at the touch of a button or even completely automatically.

	AstroTec	TempoTec	AeroTec	VarioTec	TimeTec
Page	216	217	218	218	219
Roller shutters / interior shading	•	•	◦	•	•
Awnings / exterior shading	◦	◦	•	•	
Venetian blinds	•	•	•	•	
Lighting	•				

◦ Partial fulfilment • Complete fulfilment

With numerous functions, the wired control systems for roller shutters and sun protection from elero offer the right solution for everyone.

	AstroTec	TempoTec	AeroTec	VarioTec	TimeTec
Page	216	217	218	218	219
Switching of mains voltage (230 V)	•	•	•	•	•
Switching of low voltage (< 6 V)	•		•	•	
230 V connection necessary	•	•	•	•	•
Running modes ¹	RM, JA, SW, GR	RM, JA	RM, JA, GR	RM, JA, GR	RM
External inputs / building management system / integration of audiovisual systems	•		•	•	
Manual/automatic switchover	•	•	•	•	•
Integrated buttons	•	•	•	•	•
Connectable sun sensor	•		•		
Connectable wind sensor			•		
Astro, sunset (or weekly switching time)	•	•			
Astro, sunrise (or weekly switching time)	•				
Astro shift (adjustable)	•	•			
City selection (156)	•	•			
Longitude / latitude setting	•	•			
Time zone	•	•			
Weekly switching time (1x UP and 1x DOWN per day)	•	•	•		•
Second weekly switching time (1x UP and 1x DOWN per day)	•				
Offset (subsequent closing command)	•				
Connectable light sensor / twilight function	•		◦		
Light sensor function	•		•		
Connectable wind sensor / wind sensor function			•		
Multiple languages selectable	•	•	•		
Intermediate position & ventilation position	•	•	•	•	
Tilting position / fabric tautening	•	•	•	•	
Holiday program	•	•			
Assignment of downward position approach	•	•	•		
Automatic summer/winter time switchover	•	•	•		
Run time setting	•		•		
Deactivation of group/central inputs	•		•		
Deactivation of the emergency signal (wind)	•			•	
Non-erasable memory for date of initial commissioning, relay switching frequency, total runtime	•	•	•		

¹ Running modes: see page 193

AstroTec

Timer with astro, astro evening and individual switching times



AstroTec

- Can be used as an individual, group or central control unit
- Adjustable individual, Astro evening or Astro switching times
- In combination with the Lumo (p. 228), the roller shutter becomes the perfect sunshade
- Can be integrated with adapter frame into common switch ranges

AstroTec	Set alpine white
Item number	28 060.0001

Technical data	
Rated voltage (V)	1 ~ 230 – 240
Rated frequency (Hz)	50 – 60
Switching current (A)	5 (ohmic load)
Protection class (IP)	20
Protection class (following professional assembly)	II
Ambient operating temperature (°C)	0 to +55
Including ProLine frame	• (Set)
Colour selection	alpine white
Type of mounting	Flush mounted, Ø 58 mm, wall installation, surface mounted in corresponding surface-mounted housing

Accessories	AstroTec operating unit, alpine white (for UniClic frame)
Item number	28 061.2001

	UniClic frame, alpine white (with integrated mains unit)
Item number	28 880.0001

Accessories and components	
	Adapter frame Page 220
	Surface-mounted boxes and frames Page 221
	Lumo light and twilight sensor Page 228

TempoTec

Timer



Features

- Simple timer
- Adjustable individual and Astro evening switching times
- Can be integrated with adapter frames into common switch ranges

TempoTec	white
Item number	28 041.0011

Technical data	
Rated voltage (V)	1 ~ 230 – 240
Rated frequency (Hz)	50 – 60
Switching current (A)	5 (ohmsche Last)
Protection class (IP)	20
Protection class (following professional assembly)	II
Ambient operating temperature (°C)	0 to +55
Including ProLine frame	-
Colour selection	white
Type of mounting	Flush mounted, Ø 58 mm, wall installation Surface-mounted in corresponding housing

Accessories and components



Adapter frames
Page 220



Surface-mounted boxes and frames
Page 221

AstroClic

Convenient timer



Features

- In the UniClic frame
- Astro programme like AstroTec
- Connection of the Lumo (p. 228) possible
- Can be used as individual control unit

AstroClic	
Item number	28 881.0001

Technical data	
Rated voltage (V)	1 ~ 230 – 240
Rated frequency (Hz)	50 – 60
Switching current (A)	5 (ohmic load)
Protection class (IP)	20
Protection class (following professional assembly)	II
Ambient operating temperature (°C)	0 to +55
Colour selection	alpine white
Type of mounting	Flush-mounted installation in the belt winding box

Accessories and components



Lumo
light and twilight sensor
Page 228

RevoluLine S + M
 RevoluLine L RH / L NHK
 Venetian Blind drives
 Solar drives systems
 Speciality drives
 Radio control systems
 Radio sensors
 Wired control units,
 Sensors

AeroTec

Control unit for sun protection systems



Can be used as individual or group/central control unit with preset date and time; manual operation possible.

Features

- Control depending on solar radiation, wind value and rain
- With operating unit removed; programming possible with battery operation
- Can be integrated with adapter frame into common switch ranges

AeroTec	white	Set alpine white
Item number	28 141.0011	28 140.0001

Technical data	
Rated voltage (V)	1 ~ 230 – 240
Rated frequency (Hz)	50 – 60
Switching current (A)	5 (ohmic load)
Battery type	1 x CR 2032
Protection class (IP)	20
Protection class (following professional assembly)	II
Type of mounting	Flush-mounted, Ø 58 mm, wall installation Surface-mounted in corresponding housing
Colour selection	white alpine white
Including ProLine frame	- • Set

Accessories and components

Adapter frame Page 220	Surface-mounted boxes and frames Page 221
Lumero Page 228	Aero Page 230

VarioTec

Motor or group/central control unit



Suitable as a control unit for the development of comfort control systems. Can be integrated with an adapter frame into common switch ranges

Features

- Can be used as an individual, group or central control unit
- Manual/automatic switchover
- Also available with built-in radio receiver as VarioTec-868 (p. 194)

VarioTec	white	Set alpine white
Item number	28 121.0011	28 120.0001

Technical data	
Rated voltage (V)	1 ~ 230 – 240
Rated frequency (Hz)	50 – 60
Switching current (A)	5 (ohmsche Last)
Protection class (IP)	20
Protection class (following professional assembly)	II
Permitted ambient temperature (°C)	0 to + 55
Display size (mm)	145 x 90 (inkl. Rahmen)
Type of mounting	Flush-mounted, Ø 58 mm, wall installation Surface-mounted in corresponding housing
Colour selection	white alpine white
Including ProLine frame	- • Set

Compatible Accessories	VarioTec operating unit, alpine white (for UniClic frame)	UniClic frame, alpine white (with integrated mains unit)
Item number	28 121.2001	28 880.0001

Accessories and components

Adapter frame Page 220	Surface-mounted boxes and frames Page 221
---------------------------	--

TimeTec

Daily and weekly timer



Features

- Individual control unit
- Automatic, manual and random mode
- No adapter frames available

Electric roller shutter control system with weekly timer.

TimeTec	
Item number	28 670.0001

Technical data	
Rated voltage (V)	230, ±10 %
Rated frequency (Hz)	50
Ausgänge	2 relay NC contacts (potential-bound)
Switching current (A)	5 (with $\cos \varphi = 1$)
Runtime (s)	150
Ambient operating temperature (°)	-5 to +45
Type of mounting	Ø 58 mm (flush-mounted)
Switching delay (s)	mind. 0,5
Operating modes	Auto, manual, random
Power reserve (h)	ca. 24 (at 20 °C)
Memory locations	7 x UP / 7 x DOWN
Colour selection	alpine white

Adapter frame for ProLine control units

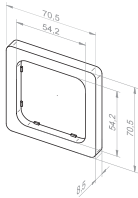

14 303.0501
Alpine white, suitable for:
– Jung-topline – Jung LS 990
– Jung LS 990
surface-mounted box

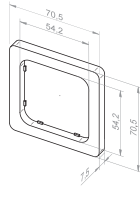

14 303.0601
White, suitable for:
– Jung-topline – Jung LS 990
– Jung LS 990
surface-mounted box

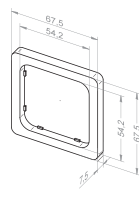

14 303.0101
Alpine white, suitable for:
– Jung CD 500
– Jung ST 550

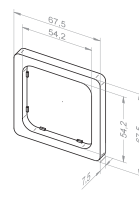

14 303.0201
White, suitable for:
– Jung CD 500
– Jung ST 550

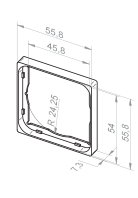

14 303.7601
Alpine white, suitable for*:
– Jung A 500 and AS 500
– AS Universal – Jung A Plus

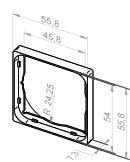

14 303.8601
White, suitable for*:
– Jung A 500 and AS 500

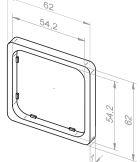

14 303.1101
Alpine white, suitable for:
– Gira surface (before 2007)

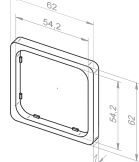

14 303.1201
White, suitable for:
– Gira surface (before 2007)

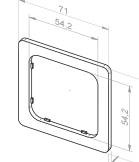

14 303.1301
Alpine white, suitable for:
– Gira Standard – Gira S-Color
– Gira surface (after 2007)

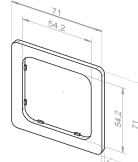

14 303.1401
White, suitable for:
– Gira Standard
– Gira surface (after 2007)

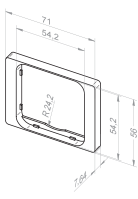

14 303.1501
Alpine white, suitable for:
– Berker Arsys

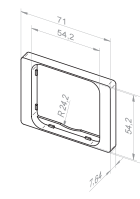

14 303.1601
White, suitable for:
– Berker Arsys

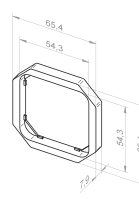

14 303.0701
Alpine white, suitable for:
– Merten Octocolor

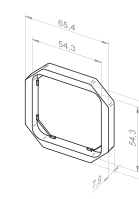

14 303.0801
White, suitable for:
– Merten Octocolor

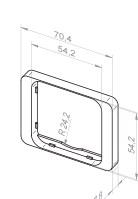

14 303.0901
Alpine white, suitable for:
– Busch-Jaeger alpha-nea

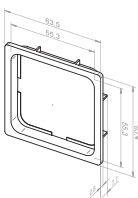

14 306.7601
Adapter frame
BJ Solo, Future,
Davos, Karat

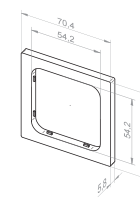

14 303.1701
Alpine white, suitable for:
– Peha Tangenta
– Peha Dialog

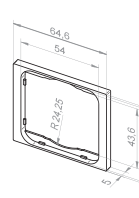

14 303.7401
Alpine white, suitable for:
– Legrand Sagane

No adapter frame is required for the following switch ranges:

- Busch-Jaeger Duro 2000 SI
- Busch-Jaeger Reflex SI

With system-inherent variations concerning the fit:

- Merten M1
- Merten Atelier

Slight variations of the colour and surface structure are possible.

* also suitable for:

- Gira Standard 55
- Gira E2 and E3
- Gira Event
- Gira Esprit
- Berker S1 and B1
- Jung A Flow
- Jung A Creation
- Merten M-Plan
- Merten M-Smart
- Merten M
- Busch-Jaeger Balance SI

Frame and sockets for ProLine control units

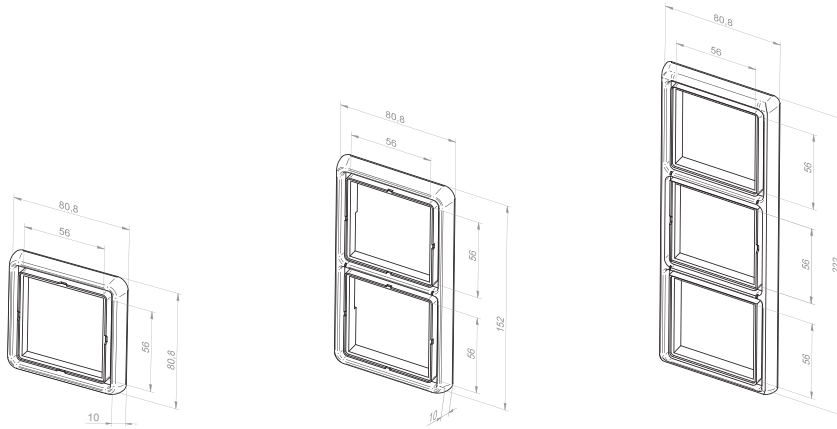

Jung CD 500 frame

Item number	Frame, 1x	Frame, 2x	Frame, 3x	alpine white	white
14 803.3901	•			•	
14 803.4001	•				•
14 803.4201		•		•	
14 803.4301		•			•
14 803.4401			•	•	
14 803.4501			•		•
ProLine frame					
18 100.0001	•			•	

Surface-mounted and flush-mounted boxes for ProLine control units

Item number	Type/Item Description
13 701.5101	Flush-mounted box, deep version
14 305.7401	Flush-mounted box for cavity walls and control panels with mounting brackets Suitable for all ProLine flush-mounted control systems
14 305.7501	Flush-mounted box for cavity walls and control panels with mounting brackets. Deep design for more space. Suitable for all ProLine flush-mounted control systems
13 702.6201	Flush-mounted junction box, suitable for two control units, dimensions: 100 x 100 mm
13 302.5601	Surface-mounted box (85 x 85 x 37 mm) for sequencing relay or central control unit for 2 AC motors
13 702.6301	Surface-mounted junction box, suitable for two 2-control units (23 994.0002); dimensions: 104 x 120 x 40 mm



13 701.5101

14 305.7401
14 305.7501

13 702.6201

13 302.5601

13 702.6301

Revoline
S + M

Revoline
L RH / L NHK

Venetian Blind drives

Solar drives systems
Speciality drives

Radio control systems
Radio sensors

Adapter frames
and sockets

Adapter frame for ProLine control units

Scale 1:1

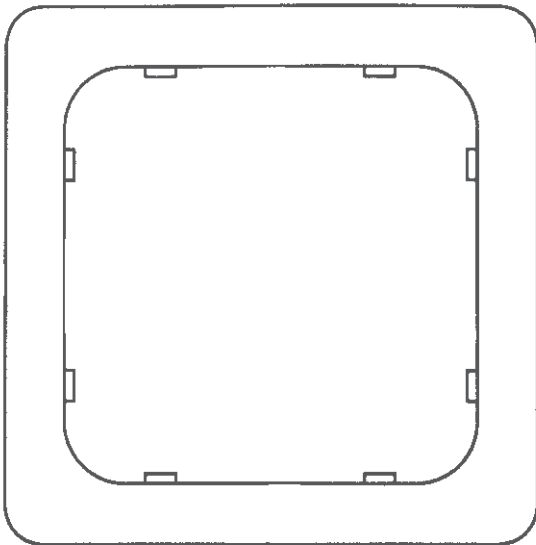

14 303.0501 alpine white
14 303.0601 white

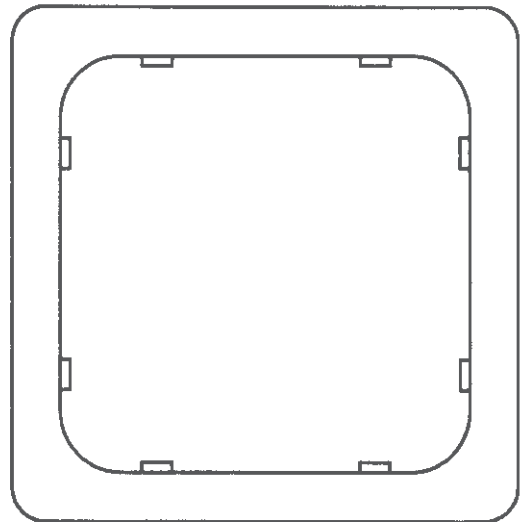

14 303.0101 alpine white
14 303.0201 white

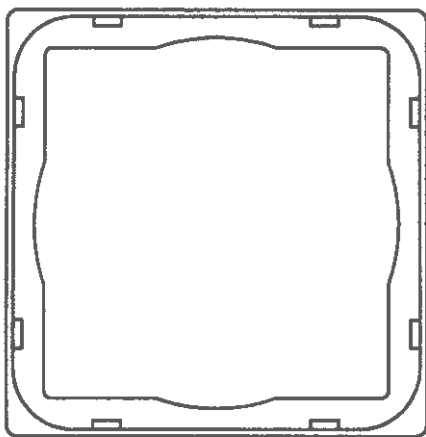

14 303.7601 alpine white
14 303.8601 white

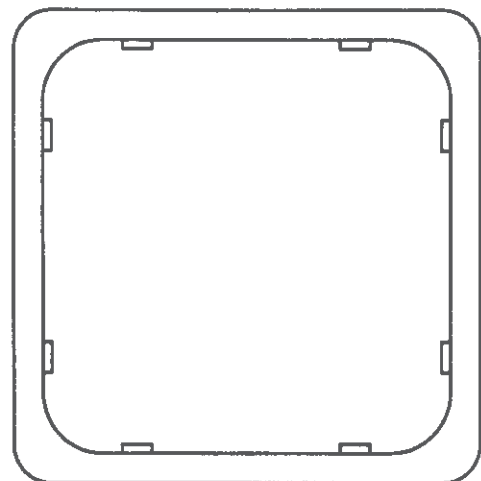

14 303.1101 alpine white
14 303.1201 white

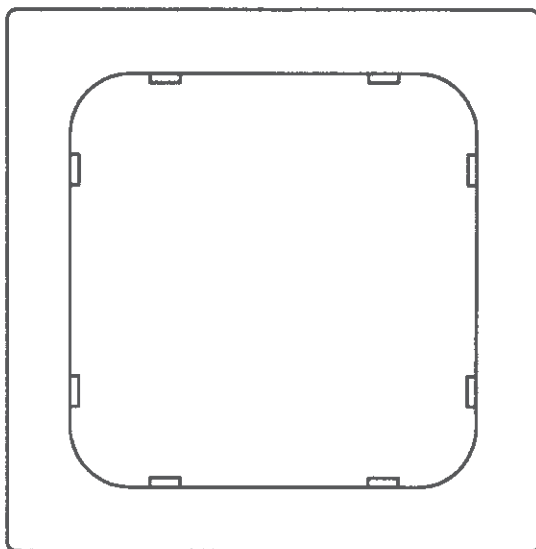

14 303.1301 alpine white
14 303.1401 white

Adapter frame for ProLine control units

Scale 1:1

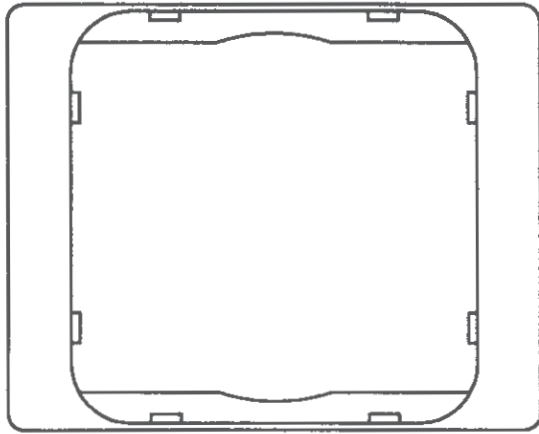

14 303.1501 alpine white
14 303.1601 white

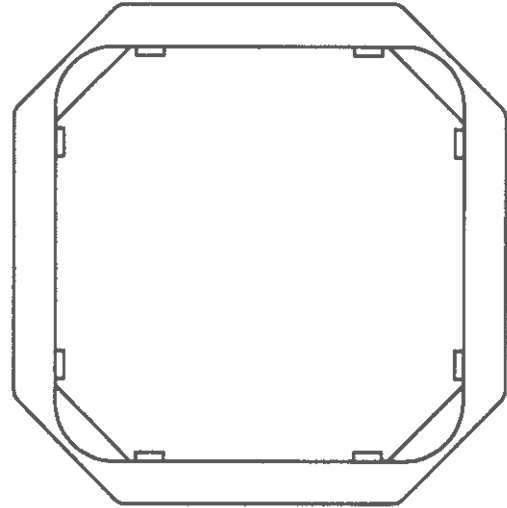

14 303.0701 alpine white
14 303.0801 white

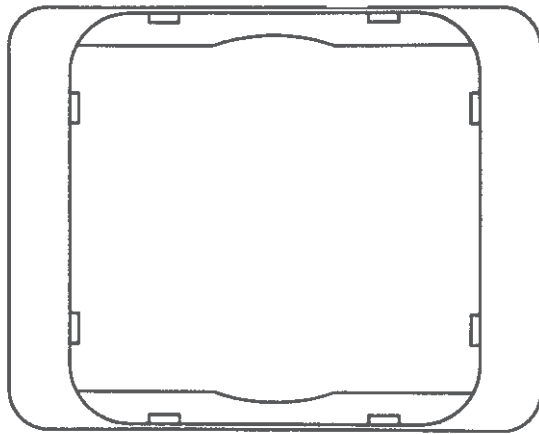

14 303.0901 alpine white

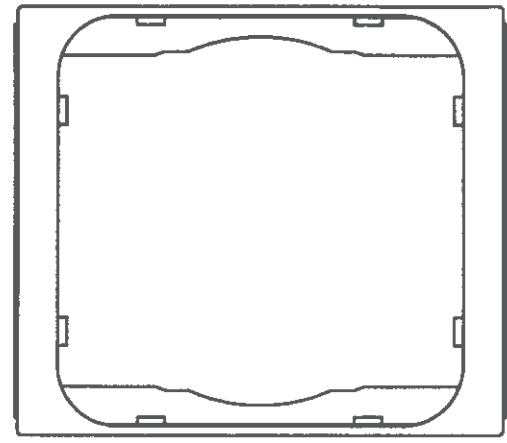

14 303.7401 alpine white

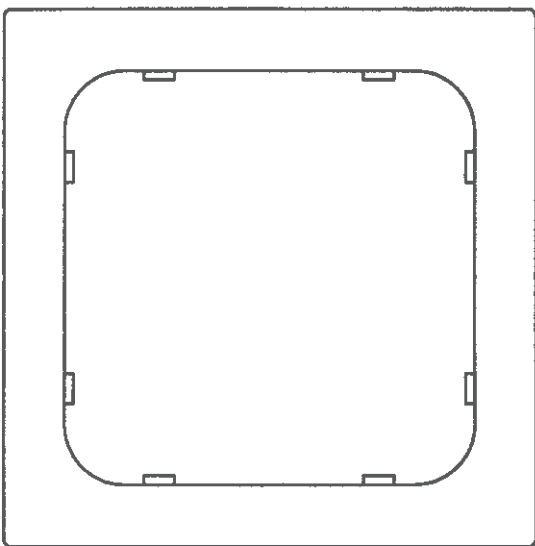

14 303.1701 alpine white

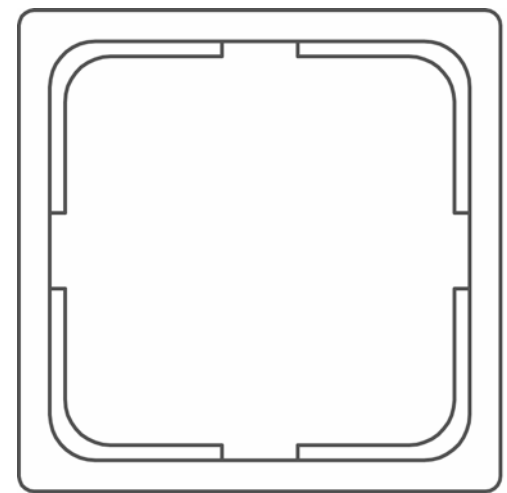

14 306.7601 alpine white



Revolution S + M
Revolution L RH / L NHK
Venetian Blind drives
Solar drives systems
Specialty drives
Radio control systems
Radio sensors
Adapter frames and sockets

elero

Sensors

Lumo	228.
Lumero	228.
Thermostat	229.
Aquero	229.
Aero	230.

Sensors



Drives and control systems are the central automation elements - but only with the right accessories can specialist trades and the industry develop solutions for complex requirements. That is why elero offer a number of sensors ranging from simple sun sensors to sophisticated weather monitors. Solar radiation, wind strength and precipitation

are monitored in this way. In addition to wired sensors, which are mainly in demand for new buildings, the product range also includes radio variants: They are characterised by quick and uncomplicated installation and are therefore often used for retrofitting.

Application areas

Sensors from elero make your everyday life easier in many situations. Roller shutters as well as awnings and venetian blinds can be controlled very easily. Your shading systems respond automatically to changes in the environment without you having to intervene.

	Lumo	Lumero	Thermostat	Aquero	Aero
Page	228	228	229	229	230
Roller shutters / interior shading	•	•	•		
Awnings / exterior shading		•	•	•	•
Venetian blinds		•	•	•	•

TOP functions

elero offer the corresponding components, for example to integrate light, wind and rain sensors conveniently in your home automation system. These devices can be operated easily and reliably in combination with suitable control systems.

	Lumo	Lumero	Thermostat	Aquero	Aero
Page	228	228	229	229	230
Light sensor	•	•			•
Twilight sensor	•	•			
Wind sensor					•
Rain sensor				•	
Thermostat (external connection)			•		
In conjunction with AstroTec/AstroTec-868	•	•			
In conjunction with AeroTec		•	•	•	•
In conjunction with AeroControl-868		•			•
Permanent measurement of the light values	•	•			•
Permanent measurement of the wind values					•
Precipitation measurement at intervals by sensor surfaces				•	
Response threshold preset at the factory				•	
Potential-free changeover contact				•	
Accessories: mast and corner mounting set (Ø 50 – 60 mm)					•

Compatibility with					
AeroTec Page 218	◦	•	• ¹	•	•
AstroTec Page 216	•	◦	• ¹	•	
AstroTec-868 Page 186	•	◦			
VarioTec Page 218			•	•	
VarioTec-868 Page 194			•	•	
Revio-868 Page 196			•	•	
Revio-868 SW Page 196			•	•	
Invio-868 Page 188				◦	
AeroControl-868 Page 197	◦	•	• ¹	•	•

◦ Partial fulfilment • Complete fulfilment

¹ Thermostat controls both directly and with sun sensor

Lumo

Light and twilight sensor



Properties

- Only in conjunction with AstroTec/AstroTec-868
- For indoor installation, on the window pane

Lumo	2.0 m	10.0 m
Item number	28 080.0001	28 090.0001

Technical data	
Protection class (IP)	20
Ambient operating temperature (C°)	0 to +55
Dimensions Ø (mm)	46 x 22
Weight (g)	17
Cable length (m)	2 10

Lumero

Light and twilight sensor



Properties

- For outdoor installation
- Only in conjunction with AstroTec/AstroTec-868, AeroContro-868 or AeroTec

Lumero	
Item number	28 180.0001

Technical data	
Protection class (IP)	43
Ambient operating temperature (C°)	-25 to +60
Dimensions H x B x T (mm)	82 x 27 x 38
Weight (g)	58

Thermostat

Room thermostat



Properties

- For external connection

Thermostat	
Item number	13 803.4801

Technical data	
Protection class (IP)	20
Ambient operating temperature (C°)	-0 to +55
Dimensions H x B x T (mm)	75 x 75 x 25
Weight (g)	76

Aquero

Rain sensor



Properties

- Precipitation measurement at intervals by sensor surfaces
- Response threshold preset at factory
- Potential-free changeover contact

Aquero	
Item number	28 690.0001

Technical data	
Rated voltage (V)	1 ~ 110 – 230
Supply voltage (Hz)	50 – 60
Protection class (IP)	44
Ambient operating temperature (C°)	-20 to +50
Output	1 potential-free changeover contact 5 A/250V
Dimensions H x B x T (mm)	300 x 170 x 65
Weight (g)	408

RevoLine
S + M

RevoLine
L RH / L NHK

Venetian Blind drives

Solar drives systems
Speciality drives

Radio control systems
Radio sensors

Sensors

Aero

Light and wind sensor



Properties

- Permanent measurement of light and wind values
- In conjunction with AeroTec (p. 218)

	Aero (white)	Aero (transparent)
Item number	28 160.0001	28 161.0001

Technical data	
Protection class (IP)	43
Ambient operating temperature (C°)	-25 to +60
Mast support	Ø 50 – 60 mm (optional accessory)
Dimensions H x B x T (mm)	280 x 130 x 130
Detection angle (°)	150
Weight (g)	286
Colour selection	alpine white

Compatible accessories	Mast and corner mounting set (Ø 50 – 60 mm)
Item number	24 269.0202

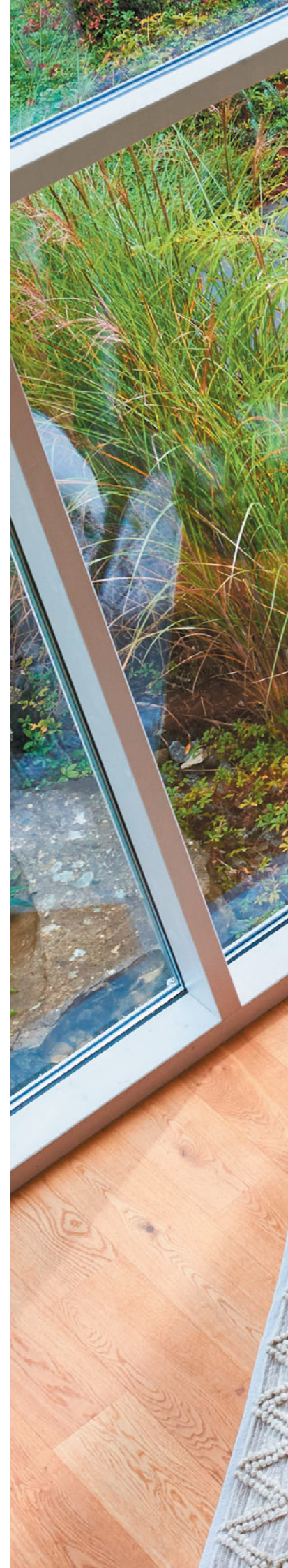

More home comfort

Sun and light penetration make a decisive difference to the ambience, your feeling of well-being and thereby also your quality of life. Light sensors regulate how much daylight to let in and prevent disruptive mirroring effects and glare. Rooms are put into the "right light" – fully automatically.



elero

Relay and special control systems

ExitSafe	236.
VarioTec-868 DC	237.
Central control units for up to 4 AC motors	238.
Central control unit for 1 AC motor without continuous phase	239.
Control Unit DC	240.
Switches and push buttons	241.

Relay and special control systems



For some applications, it is necessary to control several drives together with a single switching point. This is easy to implement with appropriate relay or control units.

The prescribed second escape route is often via patio doors. If an automatic privacy and sun protection screen is there, it must quickly clear the escape route in an emergency. elero have suitable control systems for this purpose too.

Application areas

Relay and special control systems from elero can be used individually for interior and exterior shading. The solutions for the second escape route enable your applications to be moved even in the event of a blackout so that you can safely leave your home at any time.

	Central control unit for					
	ExitSafe	VarioTec-868 DC	1 or 2 AC motors	Up to 4 AC motors	1 AC motor without continuous phase	Control Unit DC
Page	236	237	238	238	239	240
Roller shutters / interior shading	•	•	•	•	•	•
Textile sun protection	•	•	•	•	•	•
Solutions for the second escape route	•	•				
Control of 12 V DC drives	•	•				
Control of 24 V DC drives						•

◦ Partial fulfillment • Complete fulfillment

TOP functions

With the respective special control systems from elero, your own four walls can be made even more convenient and safe by, for example, connecting a smoke detector to the escape route module.

	Central control unit for					
	ExitSafe	VarioTec-868 DC	1 or 2 AC motors	Up to 4 AC motors	1 AC motor without continuous phase	Control Unit DC
Page	236	237	238	238	239	240
Operation with venetian blind push button or switch possible	•	•	•	•	•	•
Individual operation with venetian blind push button	•		•	•	•	•
Integrated buttons		•				
Motor or central / group control unit	•	•	•	•	•	◦
In conjunction with ProLine devices ¹		•	•	•	•	•
Smoke detector that can be connected	•					
Control priority that can be set	•					
Manual / automatic switchover		•				
Integrated radio receiver		•				
ProLine low-voltage inputs		•				
ProLine 230 V output			•	•	◦ ²	
ProLine potential-free output		•				
Several devices can be switched in parallel ²			•	•	•	•
Connectable elero motors						
JA motors, AC 230 V			2	4	1	
JA motors, DC 12 V (JA 04 Soft DC)	•					
AC 230 V tubular motors			2	4	1	
DC 12 V tubular motors (VariEco M10 DC / M12 DC)	•					1
DC 24 V third-party motors						

◦ Partial fulfillment • Complete fulfillment

¹ With DC control unit only: VarioTec-868, AstroTec, AeroTec, VarioTec, Revio-868 P

² Observe the maximum current consumption of all motors

ExitSafe

Solutions for the second escape route

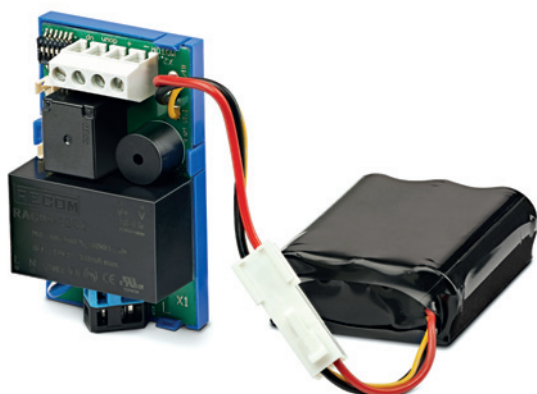

Push button or maintained mode operation, single or central operation priority, roller shutter or venetian blind operation, warning signal at low charge level, automatic upward travel at low charge level (can be deactivated), warning signal after 2 years or 500 charging cycles (can be deactivated), control units with automatic commands can be integrated.

Properties

- Smoke detector with NO or NC contact (NC contact with wire break detection) can be connected
- Individual operating input for push button or control system
- Central operating input for e.g. smoke detector or control system
- Priority can be configured
- Can be controlled directly with bidirectional radio transmitter in conjunction with VarioTec-868 DC (p. 237)

ExitSafe	
Item number	28 388.0001

Technical data	
Rated voltage (V AC)	230 / 50 Hz
Output voltage (V DC) motor terminals	8.4...12
Motor terminals / maximum current (A)	4
Output voltage for control elements (V DC) / nominal current (mA)	8.4...12 / 50
Battery type	Li-Ion
Nominal battery capacity (mAh)	3.400
Max. control factor (sec./h)	1,200/8
Operating mode	Jog mode, maintained mode, delayed maintained mode
Protection class (IP)	20
Control module dimensions (mm)	67 × 40 × 22
Battery module dimensions (mm)	70 × 55 × 20
Type of mounting	In double electronic flush-mounted box
Bidirectional radio control (extendable)	•
Ambient operating temperature (°C)	±0 to +60
Standard scope of delivery	ExitSafe control module, battery module, connection cable for operating elements, operating instructions

Can also be controlled by bidirectional radio control

When using the VarioTec-868 DC as a control unit, the existing privacy and sun protection can be operated by radio control even in the event of a blackout. Time and sun protection commands for the blinds can be activated or deactivated with the slide switch.



Compatible accessories	
Item number	Spare battery for ExitSafe module 28 388.1201



Accessories and components



VariEco M10 / M12 DC
Page 136



JA 04 Soft DC
Page 136



VarioTec-868 DC
Page 237

VarioTec-868 DC

Motor or central/group control unit



For comfort control systems.





Properties

- Integrated radio receiver
- Can be used as a motor, central or group control unit
- Manual/automatic switchover
- Suitable for roller shutters, venetian blinds, awnings and roller blinds
- 868 MHz radio frequency for reliable transmission
- Separate mains unit (12 V DC)

VarioTec-868 DC	Alpine white set
Item number	28 345.0006

Technical data	
Rated voltage (V)	12 (DC)
Switching current (A)	5 (cos φ= 1)
Protection class (IP)	20
Protection class (following professional assembly)	II
Ambient operating temperature (°C)	0 to +55
Radio frequency (MHz)	868
Unidirectional radio control	•
Bidirectional radio control	•
Includes ProLine frame	•
Colour selection	Alpine white set
Type of mounting	Flush mounted, Ø 58 mm wall installation, surface mounted in corresponding housing

Accessories and components

	Adapter frame Page 220		Surface-mounted boxes and frames Page 221
	Radio transmitters from page 180		

Revolution S + M
Revolution L RH / L NHK
Venetian Blind drives
Solar drives systems
Speciality drives
Radio control systems
Radio sensors
Relay and special control systems

Central control units

For 1 or 2 AC motors

For up to 4 AC motors



Properties

- Operation of several drives from one switching point with a venetian blind push button or switch is possible, as is automatic switching with ProLine control units and individual operation with a venetian blind push button.
- Observe the overall phase load when designing the complete system. The number of sequencing relays that can be switched sequentially depends on the current consumption of the motors used. The back-up fuse must not exceed a max. value of 10 A.

Central control unit (sequencing relay) for 1 or 2 single-phase motors

Item number	23 994.0002
-------------	-------------

Technical data

Rated voltage (V)	1 ~ 230 – 240
Rated frequency (Hz)	50 – 60
Current consumption (mA)	10 in relay mode
Switching capacity	Max. 2 x 3 A, 250 V AC, max. motor load 2 x 690 VA, only for 230 V motors with end position switches
Protection class (IP)	20
Ambient operating temperature (°C)	0 to +60
Back-up fuse (A)	max. 10
Dimensions H x W x D (mm)	47 x 52 x 21
Maximum number of drives	2
Weight (g)	57

Central control unit for up to 4 AC motors

Item number	24 816.0002
-------------	-------------

Technical data

Rated voltage (V)	1 ~ 230 – 240
Rated frequency (Hz)	50 – 60
Current consumption (mA)	20
Switching capacity	max. 4 x 6 A, 250VAC
Protection class (IP)	20
Ambient operating temperature (°C)	-10 to +40
Back-up fuse (A)	10 slow-acting
Dimensions H x W x D (mm)	115 x 65 x 190
Maximum number of drives	4
Weight (g)	863

Accessories and components

	Switches and push buttons Page 241		Switches and push buttons Page 253
	Surface-mounted box for sequencing relay Page 221		Switches and push buttons Page 253

Accessories and components

	Switches and push buttons Page 241		Switches and push buttons Page 253
	Switches and push buttons Page 253		

Central control unit

For 1 AC motor without continuous phase

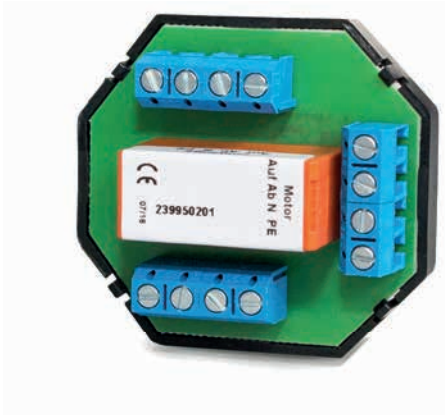

Properties

- Operation of several drives from one switching point with a venetian blind push button or switch is possible, as is automatic switching with ProLine control units and individual operation with a venetian blind push button
- Observe the overall phase load when designing the complete system. The number of sequencing relays that can be switched sequentially depends on the current consumption of the motors used. The back-up fuse must not exceed a max. value of 10 A
- Also suitable as a light change switch / multi-point control

Central control unit for 1 AC motor without continuous phase

Item number	23 995.0201
-------------	-------------

Technical data

Rated voltage (V)	1 ~ 230 – 240
Rated frequency (Hz)	50 – 60
Current consumption (mA)	10 in relay mode
Switching capacity	8 A AC1, 4 A cos phi 0.6
Protection class (IP)	20
Ambient operating temperature (°C)	
Back-up fuse (A)	
Dimensions H x W x D (mm)	49 x 53 x 22
Maximum number of drives	1
Weight (g)	59

Accessories and components



Switches and push buttons
Page 241



Switches and push buttons
Page 253



Switches and push buttons
Page 253

Control Unit DC

Control of 24 V DC drives



Properties

In conjunction with the following ProLine devices

- AstroTec (p. 216)
- AeroTec (p. 218)
- VarioTec-868 (p. 194)
- VarioTec (p. 218)
- Revio-868 P (p. 196)
- VarioTec-868 DC (p. 237)
- Instead of a ProLine device, a venetian blind push button (p. 241) can be connected to actuate the DC control unit

Control Unit DC	
Item number	28 855.0001

Technical data	
Rated voltage (V)	24V DC, ± 10%
Control voltage	24V DC, ± 10%
Current consumption (mA)	25
Switching capacity (A)	3
Protection class (IP)	20
Ambient operating temperature (°C)	0 to +55
Dimensions H x W x D (mm)	52 x 49 x 29
Type of mounting	Suitable for flush-mounted boxes Ø 60 mm

Accessories and components



ProLine controllers:
From page 214

¹¹ In conjunction with AstroTec and AeroTec ¹² In conjunction with AstroTec ¹³ In conjunction with AeroTec

Switches and push buttons



Flush-mounted venetian blind switch



Rotary switch



Surface-mounted venetian blind switch

Venetian blind switch / push button for flush-mounted AC drives

Item number	Type/Item Description
24 051.0001	Jung CD 500 venetian blind switch, alpine white
24 222.0001	Jung CD 500 venetian blind push button, alpine white

Rotary switch, 2-pin, flush-mounted

Item number	Type/Item Description
13 701.3401	Rotary switch, 2-pin, flush mounted for connecting 2 motors (can be used as a switch / push button)

Venetian blind switch / push button for surface-mounted AC drives

Item number	Type/Item Description
14 701.1701	Switch (with latched position), surface-mounted, water-proof
14 701.2101	Push button (without latched position), surface-mounted, water-proof

elero

Door drives

Door control systems

Type 15 W	244.
Type 15 W NMA	245.
<i>Accessories door drives</i>	246.
DoorControl	251.

Type 15 W

Tubular drives for doors



Interchangeable couplings (adapters) for tubes from Ø 98 x 2.0 mm to 168 x 4.0 mm or size 114 (octagonal), long service life, quiet running of the drive thanks to optimum toothting. The mounting plates of the Type 15 W... drives must be mounted at a right angle to the mounting surface. It is imperative to use the wall anchor pocket item no. 23 100.0001 in the event of unevenness.

Type 15 W

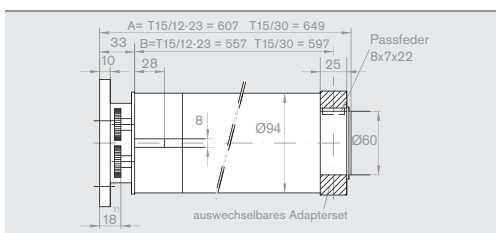

1) Lateral space requirement when overwinding the limit switch

Type 15 W 	Type 15/12 W	Type 15/15 W	Type 15/18 W	Type 15/23 W	Type 15/30 W
Item number	32 301.0002	32 281.0002	32 321.0002	32 361.0002	32 381.0002

Technical data

Rated torque (Nm)	120	150	180	230	300
Rated speed (rpm)	12	12	12	12	12
Rated voltage (V)	1 ~ 230	1 ~ 230	1 ~ 230	1 ~ 230	1 ~ 230
Rated current (A)	3.4	3.5	3.6	3.9	5.5
Rated power consumption (W)	700	740	780	810	1,250
Operating time (min S2)	6	6	6	4	4
Min. shaft diameter (mm)	98	98	98	98	98
Protection class (IP)	44	44	44	44	44
Limit switch range (rev.)	36	36	36	36	36
Door cycles per hour $\frac{1}{h}^{-1}$ *	6	6	6	6	6
Length A (mm)	610	610	610	610	650
Length B (mm)	560	560	560	560	600
Weight (kg)	11.4	11.4	11.4	11.4	13.0
Ambient operating temperature (°C)	-20 to +60	-20 to +60	-20 to +60	-20 to +60	-20 to +60

* One door cycle is 5 revolutions OPEN – 30 sec. pause – CLOSED

Compatible accessories	Wall anchor pocket for Type 15 W (with axial safety)
Item number	23 100.0001

	Wall anchor plate for Type 15 W
Item number	13 301.4901

Accessories, such as connection and assembly cables, adapter sets and motor bearings, can be found in the section "Type 15 accessories" on page 246. Suitable control systems as well as radio transmitters and sensors can be found in the section "Radio controls" from page 180.

Type 15 W NMA

Tubular drives with emergency manual operation for doors



Emergency manual operation possible during blackout, interchangeable couplings (adapters) for tubes from Ø 98 x 2.0 mm to 168 x 4.0 mm or size 114 (octagonal), long service life, quiet running of the drive thanks to optimum toothing. The mounting plates of Type 15 W... drives must be mounted at a right angle to the mounting surface. It is imperative to use the wall anchor pocket item no. 23 100.0001 in case of unevenness.

Type 15 W NMA

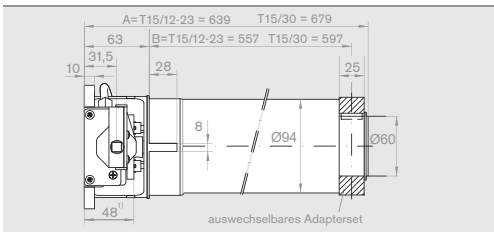

1) Lateral space requirement when overwinding the limit switch

Type 15 W NMA 	Type 15/12 W NMA	Type 15/15 W NMA	Type 15/18 W NMA	Type 15/23 W NMA	Type 15/30 W NMA
Item number	32 312.0002	32 292.0002	32 332.0002	32 362.0002	32 382.0002

Technical data

Rated torque (Nm)	120	150	180	230	300
Rated speed (rpm)	12	12	12	12	12
Rated voltage (V)	1 ~ 230	1 ~ 230	1 ~ 230	1 ~ 230	1 ~ 230
Rated current (A)	3.4	3.5	3.6	3.9	5.5
Rated power consumption (W)	700	740	780	810	1,250
Operating time (min S2)	6	6	6	4	4
Min. shaft diameter (mm)	98	98	98	98	98
Protection class (IP)	44	44	44	44	44
Limit switch range (rev.)	36	36	36	36	36
Door cycles per hour h^{-1} *	6	6	6	6	6
Transmission ratio between NMA and winding shaft	243:1	243:1	243:1	243:1	243:1
Length A (mm)	640	640	640	640	680
Length B (mm)	590	590	590	590	630
Weight (kg)	12.1	12.1	12.1	12.1	13.8
Ambient operating temperature (°C)	-20 to +60	-20 to +60	-20 to +60	-20 to +60	-20 to +60

* One door cycle is 5 revolutions OPEN – 30 sec. pause – CLOSED.

Compatible accessories	Wall anchor pocket for Type 15 W (with axial safety)
Item number	23 100.0001
	Wall anchor plate for Type 15 W
Item number	13 301.4901

Accessories, such as connection and assembly cables, adapter sets and motor bearings, can be found in the section "Type 15 accessories" on page 246. Suitable control systems as well as radio transmitters and sensors can be found in the section "Radio controls" from page 180.

Drive adapters

Profiles of the adapter sets in 1:1 scale can be found on page 270.



Item number	Type/Item Description	Notch tubes	M8 thread
13 103.5701	Ø 98 x 2.0 mm	•	•
23 584.0001	Ø 102 x 2.0 mm	•	•
23 475.0001	Ø 108 x 3.6 mm	•	
23 527.0001	Ø 108 x 3.6 mm drilled	•	•
23 494.0002	Ø 133 x 2.0 mm	•	•
23 325.0001	Ø 133 x 2.5 mm	•	•
23 495.0002	Ø 133 x 4.0 mm	•	
23 495.0101	Ø 133 x 4.0 mm	•	•
23 309.0001	Ø 159 x 2.6 mm	•	•
23 310.0001	Ø 159 x 4.5 mm	•	•
23 027.0001	Ø 168.3 x 4.5 mm and Ø 168 x 4 mm	•	•
23 456.0001	114 mm WAF, octagonal (side-to-side dimension of 125 mm)		
23 311.0001	Ø 120 mm, Alukon	•	•

Assembly accessories

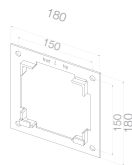

23 100.0001

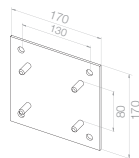

13 301.4901

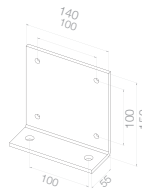

13 305.9201

Item number	Type/Item Description
23 100.0001	Wall anchor pocket (with axial safety)
13 301.4901	Wall anchor plate
13 305.9201	Angle bracket

Manual operation

Crank handles



24 049.0001
Crank with ball joint,
x = 0.85 m



24 050.0001
Crank with ball joint,
x = 1.35 m



12 300.0901
Crank with awning hook,
length of 1.40 m



23 398.9801
Awning eyelet for
type 15/... NMA

NMA basic set

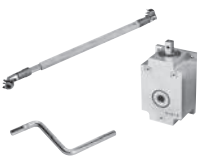

23 199.9501
Consisting of angle drive /
drive shaft / crank



23 081.0001
Drive shaft, extensible
1.70 – 3.00 m

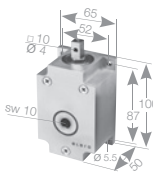

23 030.0001
Angle drive



13 305.8001
Crank for angle
drive, length of
0.20 m

Cables and accessories



23 395.8502

Item number	Type/Item Description
23 395.8502	Assembly cable
13 710.5101	Fast clamp as replacement for assembly cable 23 395.8501

Revolution
S + M

Revolution
L RH / L NHK

Venetian Blind drives

Solar drives systems
Speciality drives

Radio control systems
Radio sensors

Wired control units
Sensors

Door drives
Door control units

Delivery time on request

Safety brakes

With electrical cut-out, degree of protection: IP 65, tested by TÜV Süd

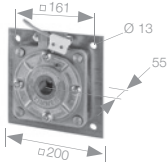

24 541.0002
TA 1/2 RD with bracket for wall mounting, Ø 30 mm
Max. torque: 332 Nm
Max. operating speed: 22 rpm
Test number: 02165

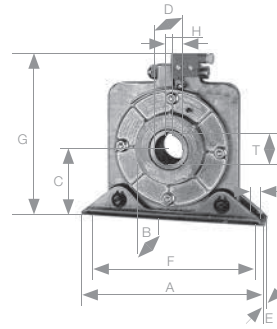

Pedestal bearing



24 552.0003
TA 1/2 RD Ø 30 mm
Max. torque: 332 Nm
Max. operating speed: 22 rpm,
test number: 02165

Choice of safety brake

	24 541.0002 TA 1/2 RD	24 552.0003 TA 1/2 RD
Door size h x b mm	3,000 x 3,000	
108.0 x 4.0	475	
133.0 x 4.0	450	
168.3 x 4.5	370	
193.7 x 5.4	325	
219.1 x 5.9	282	
244.5 x 5.9	246	
298.5 x 8.0	190	
323.9 x 8.0		
355.6 x 8.0		

These data relate to the complete door weight in kg.

Item number	A	B	C	D ^{H7}	E	F	G	H ^{H9}	I	T	kg
24 552.0003	210	44	80	30	38	180	185	8	12	33.3	4.5

Welding shafts

Item number	Shaft Ø (mm)	Key (mm)	Length (mm)
24 045.0001	30	8 x 7 x 50	500

- a) Safety brake TA 1/2
- b) Chain wheel with boss

a) Bearing side:
with safety brake

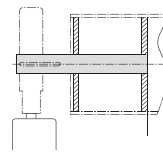

b) Drive side:
with chain wheel with boss

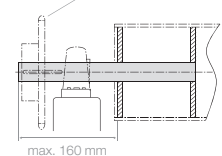

Welding shafts, bearing side

Item number	Shaft Ø (mm)	Key (mm)	Length (mm)
14 110.8001	30	8 x 7 x 50	500

- c) For pedestal/flange bearing
- d) Sprocket wheel

c) Bearing side:

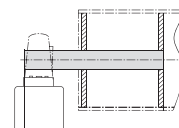

d) Drive side: with sprocket wheel

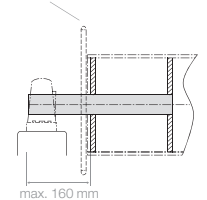

Delivery time on request

Ronden



for the welding shafts and counterpart supports

Item number	For shaft Ø (mm)	Blank Ø (mm)	Thickness (mm)	Bore Ø (mm)
13 117.6001	98 x 2.0; 100 x 3.0; 101.6 x 3.6	93	4	30
14 110.3301	108.0 x 3.6	99	4	30
14 110.3201	133.0 x 4.0	124	6	30
13 117.6101	133.0 x 2.0	128,5	6	30
13 117.6201	159.0 x 4.5	149	6	30
13 119.7601	159.0 x 2.6	153	6	30
14 110.5401	168.3 x 4.5	158,5	6	30
14 110.6001	168.3 x 3.0	161,5	6	30
14 110.9501	193.7 x 5.4	181,5	6	30
14 110.9601	193.7 x 3.0	187	6	30

Brackets

Wall brackets

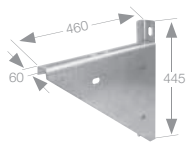

Max. load: 3,000 N

24 399.0001

3 kN, right with 2 hexagonal screws, M12 x 50 and nuts, for DFM/WFM 100 - 350, safety brake TA 1/2 RD

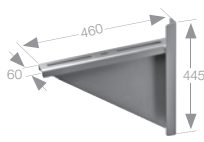

Max. load: 3,000 N

24 313.0001

3 kN, left with 2 hexagonal screws, M 12 x 50 and nuts, for DFM/WFM 100 - 350, safety brake TA 1/2 RD

Screw-on angle

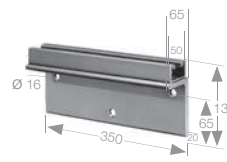

Max. load: 5,300 N

24 553.0101

5.3 kN for pedestal bearing, safety brake TA 1/2 RD and TA 2/3 RD

Pedestal and flange bearings

Pedestal bearing

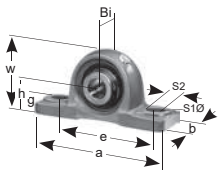

13 300.7701

With grub screw fastening Ø 30 mm



13 300.3701

Ø 20 mm

Plate bearing



13 300.3101

Ø 20 mm

Flange bearing

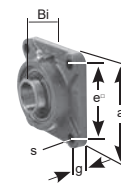

13 300.3201

Ø 30 mm

Item number	a	b	e	g	h	w	S1Ø	S2	Bi	kg
13 300.7701	165	48	121	15	42,9	84	17	21	38.1	1.3

Item number	a	e	g	SØ	Bi	kg
13 300.3201	108	83	13	12	38.1	1.1

Screws for pedestal bearings and safety brakes



14 300.5501

T-head screws (M10 x 40) with M10 nut for fastening the pedestal bearing to the screw-on angle (2 required)



14 300.5601

T-head screws (M12 x 50) with M12 nut (for pedestal bearing with Ø 30 and Ø 40 and TA 1/2 RD / TA 2/3 RD safety brake on the screw-on angle, item no. 24 553.0101)

Intelligent door control systems

The DoorControl system for motorised roller garage doors, roller grilles or small industrial roller doors has been developed specifically for AC tubular drives with mechanical limit switches.

It complies with the European standards “Safety in use of power operated doors” EN 12453 and EN 12445. It is also naturally CE compliant and certified by the TÜV.

Control system selection table for DoorControl

Control system selection	DoorControl		
	Without radio control	for rolling doors 868.8 MHz	For roller grilles *2) Without radio control
*1) Recommendations for doors shown below			
Doors for commercial and industrial use etc. Pulse control with or without sight of the door (maintained mode), automatic control with traffic lights	•	•	•
Rolling doors or roller grilles for underground garages etc. Automatic control / two-way traffic with red/green traffic lights	•	–	–
Features			
Automatic closing with traffic light function	•	•	•
Test of the opto-electronic door-edge security system for 8.2 KΩ resistance evaluation	•	•	•
*2) Test of the ingress protection system integrated	–	–	–
Automatic drive cut-out at the end positions	•	•	•
“CLOSED” light barrier connection	•	•	•
Connection of pre-end switch	•	•	•
Garage light connection	•	•	–
Integrated radio receiver FM 868.8 MHz	–	•	–
Connection of timer possible	•	•	•

*1) Please be sure to follow EN 12453!
 § 5.5. Table 1 – Observe “Minimum protection levels for security of main door-edge”!
 Maintained mode only if this represents no risk of injury or damage.
 Connection of protection systems is essential.

*2) Ingress protection unit with testing for roller grille can be connected
 Item no. 17 700.5401 light barrier test unit for 2 one-way light barriers, item no. 24 961.0001 or 24 960.0301 or requirements for the light barriers: 24 V DC voltage; power consumption </= 1.5 VA; ready delay 250 ms

DoorControl

Door control system for tubular drives



DoorControl

- Closing edge evaluation
- Dynamic motor runtime monitoring
- Output for interior light or also warning lights
- Automatic operation of door systems with 230 V AC drives

DoorControl RG

- Suitable for roller grilles
- Draw-in protection testing possible by light barrier test unit

For type 15 W NHK and NMA with mechanical limit switch
1 x 230 V / 50 Hz.

	DoorControl for rolling doors			DoorControl for roller grilles
Item number	24 180.0001	24 180.0301	24 180.0101	24 080.0101

Technical data				
Supply voltage (V)	230			230
Rated frequency (Hz)	50–60			50–60
Power consumption (W)	max. 6			max. 6
On-site fuse protection (A)	max. 10			max. 10
Switching current (A)	max. 6			max. 6
Switching capacity (VA)	max. 1,300			max. 1,300
Protection class IP	54			54
Ambient operating temperature (°C)	-10 to +50			-10 to +50
Dimensions L x W x H (mm)	180 x 130 x 60			180 x 130 x 60
Conformity	EN 12453 PL c / cat. 2 according to EN ISO 13849-1:2008 for the safe function of the door-edge security system			
Radio version	•	•	-	-
Incl. radio receiver	•	•	-	-
Incl. hand-held radio transmitter	•	-	-	-
Incl. slot for radio module	-	-	•	•
Standard scope of delivery	The control system is supplied with a 1.5 m connection cable with earthing contact plug and a membrane keypad (up-stop-down) built into the housing cover.			

Radio receiver in housing, 2-command 868 MHz for downstream control systems				
Item number	-			17 700.4201

Further accessories on the following pages.

Radio remote controls, 868.8 MHz

2-command radio receiver, 868.8 MHz in housing, 230 V AC



17 700.4201
For downstream control systems: push-button, on/off switching operation, timer mode, switch-off delay up to 250 sec.

Rod antenna FM 868.8 MHz



17 700.4901
For radio receiver 17 700.4201
50 ohms – coaxial cable (10.0 m)

4-command radio hand-held transmitter



17 700.3701
Up to 50 m, environment-dependent, secure "SOMLOQ" rolling code system, 3 V battery, CR 2032, housing can be pulled out

Wall mount holder



17 700.3901
For hand-held radio transmitter 17 700.3701

Safety for crushing, shearing and ingress points

Door-edge security system (opto-electronic safety edge)

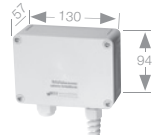

14 705.9002
Evaluation unit for 230 V/50 Hz mains voltage, switching contact potential-free (in plastic housing IP 66)

Line connection box



24 275.0001
Transmitter, cable length of 1.0 m + receiver, cable length of 10.5 m, approx. range of 1.0 m - max. 8.0 m, Ø 11 mm

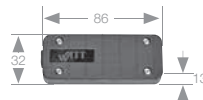

23 173.0002
With strain relief for spiral cable, integrated plug-in/screw terminals incl. screwdriver



14 705.2801
Spiral cable 3 x 0.5 mm²
Extensible, 0.9 - 3.0 m

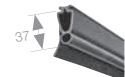

14 706.2601
Safety edge rubber, double chamber with lip

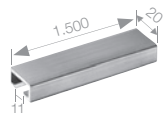

14 701.0602
Aluminium C-rail for safety edge rubber, 1.5 m long

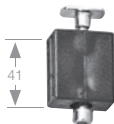

23 255.0002
Stoppers (pair)

Reflection light barrier with polarizer IP 67



24 960.0201
Accessories: reflector, angle bracket, screw fitting and fixing screws on the holding bracket. Range: 0.50 ... 15.0 m; rated voltage: 15 - 45 V DC or 24 V AC; ready for operation: < 100 ms; rated current: max. 30 mA/24 V

Note:
The reflectors for the reflection light barrier can fog up outdoors due to weather effects, frost etc., thus drastically reducing their range. Recommendation: one-way light barriers are suitable outdoors even in tough conditions.

One-way light barrier IP 67



24 961.0001
Set: transmitter, receiver and fastening part. Plastic housing. Range: max. 50.0 m; rated voltage: 20 - 230 V AC/DC. Output: relay

One way "Twin-Safe" light barrier



24 960.0301
For ingress protection accessories: angle bracket
Range: 1.0 - 20 m, rated voltage: 10 - 30 V DC
Opening angle: < 4°, rated current: 70 mA

Light barrier test unit

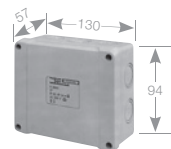

17 700.5401
Function only with BoxCard premium and DoorControl for roller grilles for 2 one-way light barriers, item no. 24 960.0301 or 24 961.0001

Weather protection bonnets suitable for the angle brackets



14 306.8501
For reflection light barrier



14 306.8601
For reflector

Timers and traffic lights

LED Lamp E27 25 mA;
1 x 230V 50/60 Hz

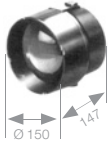

14 700.3801
Traffic light red



14 700.3901
Traffic light green

Switches and push buttons

Surface-mounted push-button switch



14 701.1701
Switch (with latched position),
water-proof



14 701.2101
Push button (without latched
position), water-proof

Surface-mounted key switch IP 54



14 701.3301
With latched position on
both sides and cover lock



14 701.3601
Without latched
position, momentary
on both sides and
cover lock



14 701.3801
Momentary on one side
and cover lock

Flush-mounted key switch IP 54



14 701.3901
With latched position on
both sides and cover lock



14 701.4201
Without latched position,
momentary on both
sides and cover lock



14 701.4401
Momentary on one side
and cover lock

Surface-mounted push button



14 701.2401

Surface-mounted push button, water-proof IP 54



14 701.2501
"Up-Down"



14 701.2901
"Up-Stop-Down"

Key push button switch, surface-mounted IP55



14 701.4501
"UP -DOWN" key switch,
momentary on both sides
and "STOP" push button

Key push button switch, surface-mounted IP55



14 701.4801
"UP -DOWN" key switch,
momentary on both sides
and "STOP" push button



14 703.1301
Surface-mounted pull
switch, aluminium housing



14 703.2601
Main switch, lockable,
surface mounted,
4-pin, 400 V, 4 kW



14 703.2701
EMERGENCY-STOP
impact button, surface
mounted

RevLine
S + M

RevLine
L RH / L NHK

Venetian Blind drives

Solar drives systems
Speciality drives

Radio control systems
Radio sensors

Wired control units
Sensors

Door drives
Door control units

Adapterprofiles

RevoLine S

Notch tubes

Scale 1:1 / Dimensions in millimetres

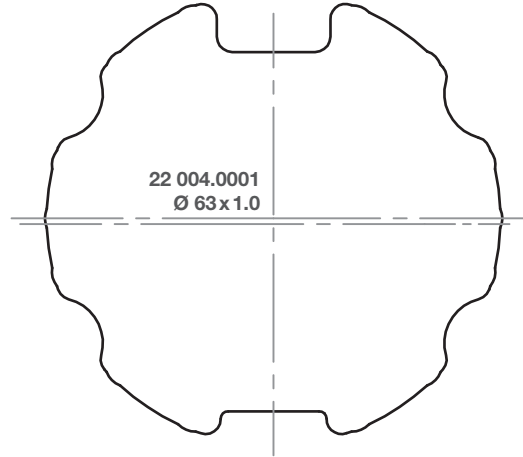
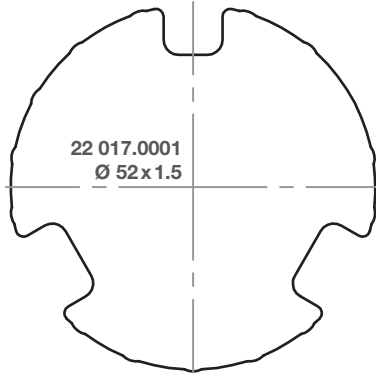

Round tubes

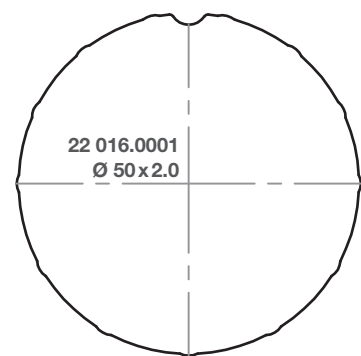
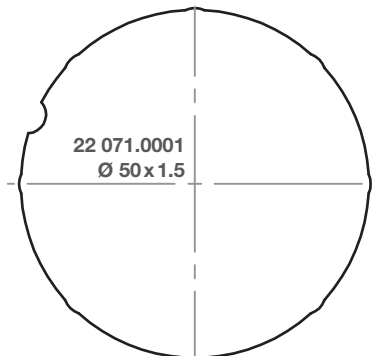
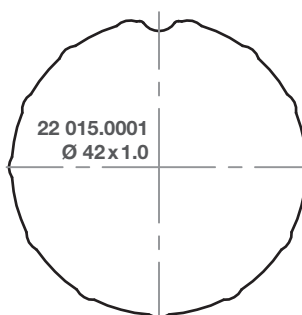
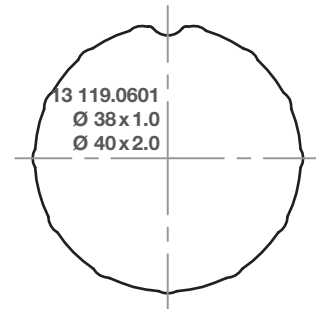
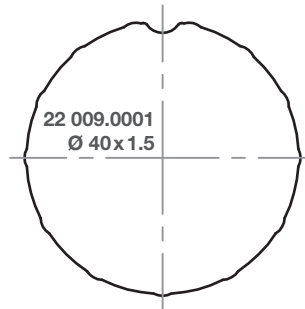
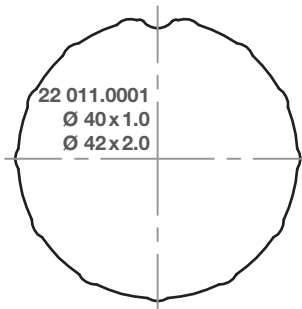



Adapterprofiles

RevoLine S

Profile tubes

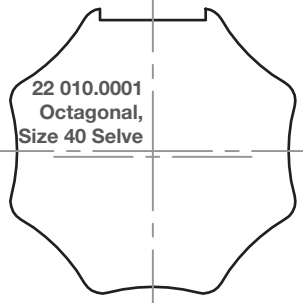
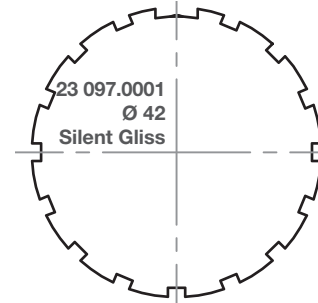
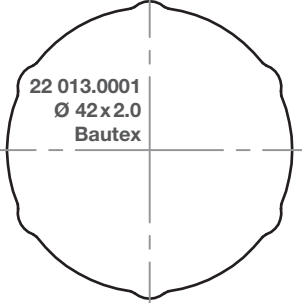
Scale 1:1 / Dimensions in millimetres

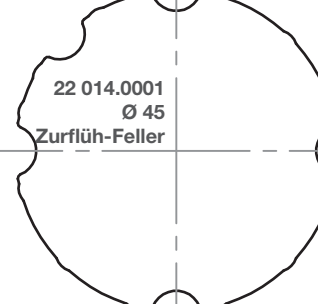
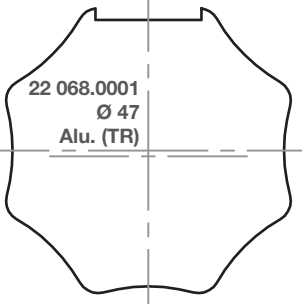
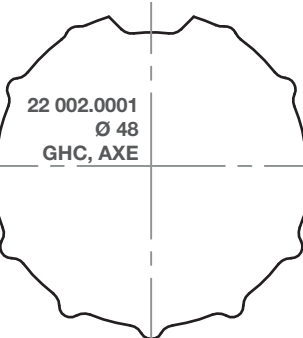
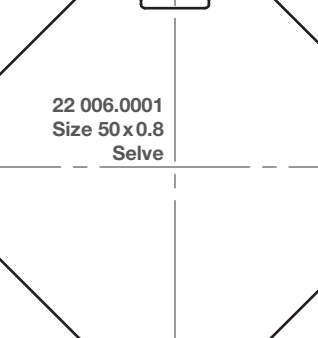
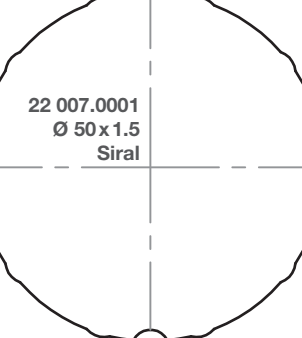
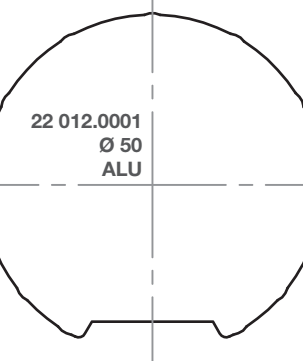
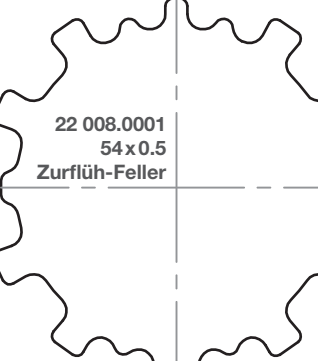
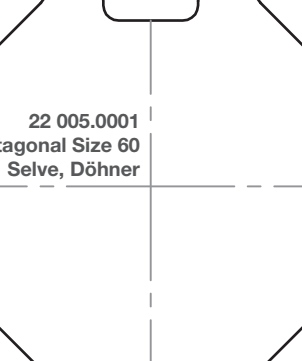
 <p>22 010.0001 Octagonal, Size 40 Selve</p>	 <p>23 097.0001 Ø 42 Silent Gliss</p>	 <p>22 013.0001 Ø 42x2.0 Bautex</p>	<p>RevoLine S + M</p>
 <p>22 018.0001 Ø 43.5 Ø 44 TechnoLight Garattoni Acmeda</p>	 <p>22 014.0001 Ø 45 Zurflüh-Feller</p>	 <p>22 068.0001 Ø 47 Alu. (TR)</p>	<p>RevoLine L RH / L NHK</p>
 <p>22 002.0001 Ø 48 GHC, AXE</p>	 <p>22 006.0001 Size 50 x 0.8 Selve</p>	 <p>22 007.0001 Ø 50 x 1.5 Siral</p>	<p>Venetian Blind drives</p>
 <p>22 012.0001 Ø 50 ALU</p>	 <p>22 008.0001 54 x 0.5 Zurflüh-Feller</p>	 <p>22 005.0001 Octagonal Size 60 Selve, Döhner</p>	<p>Solar drives systems Speciality drives</p>
			<p>Radio control systems Radio sensors</p>
			<p>Wired control units Sensors</p>
			<p>Door drives Door control units</p>
			<p>Adapterprofiles</p>

Adapterprofiles

RevoLine M

Notch tubes

Scale 1:1 / Dimensions in millimetres

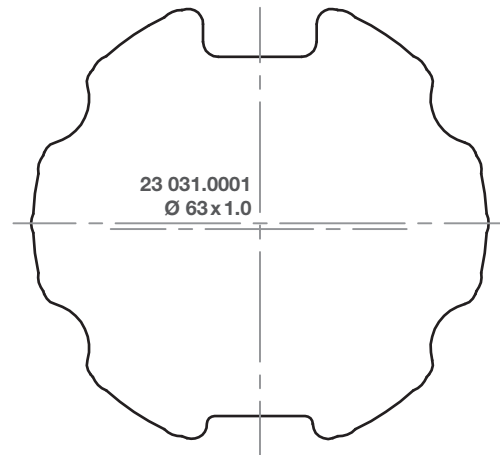
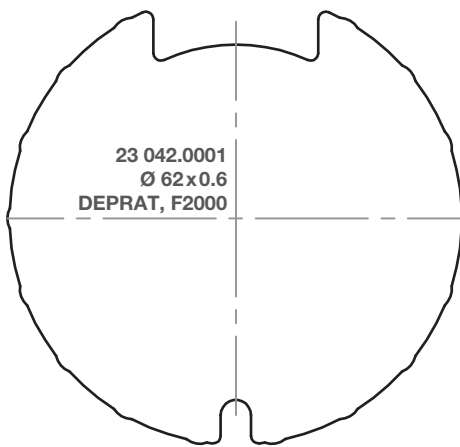
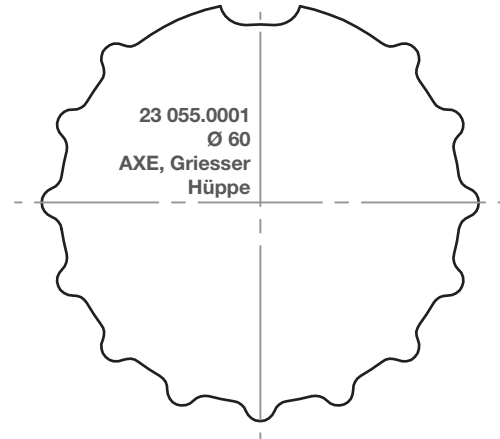
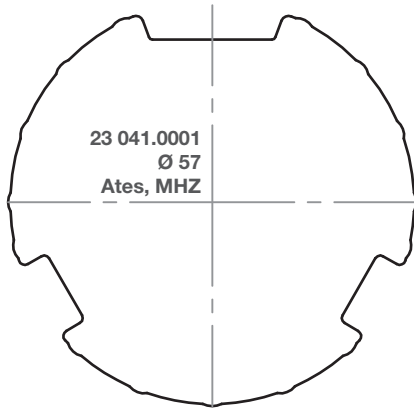

Adapterprofiles

RevoLine M

Notch tubes

Scale 1:1 / Dimensions in millimetres

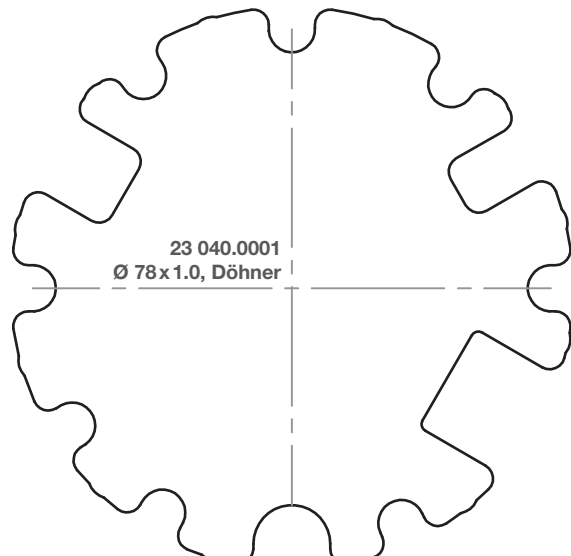
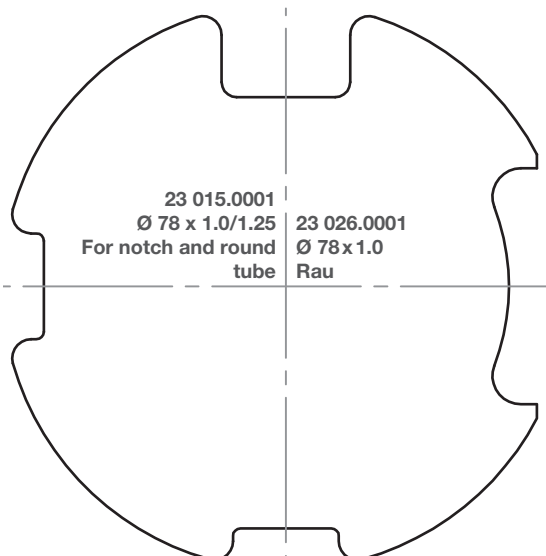
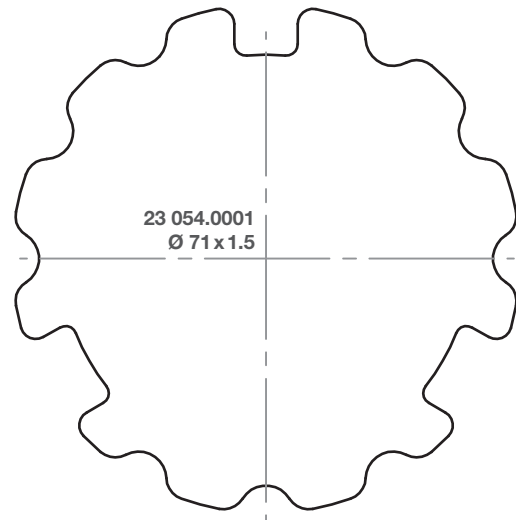
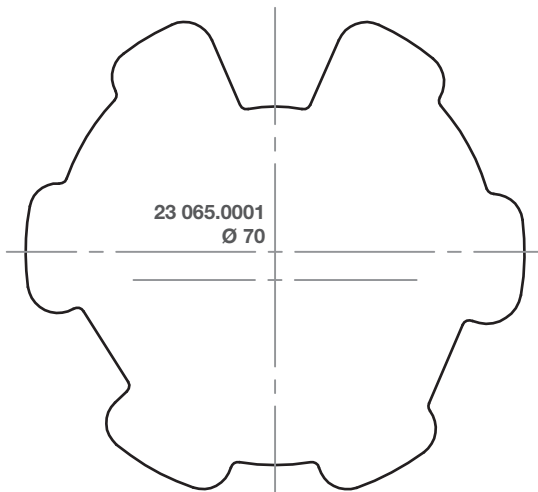
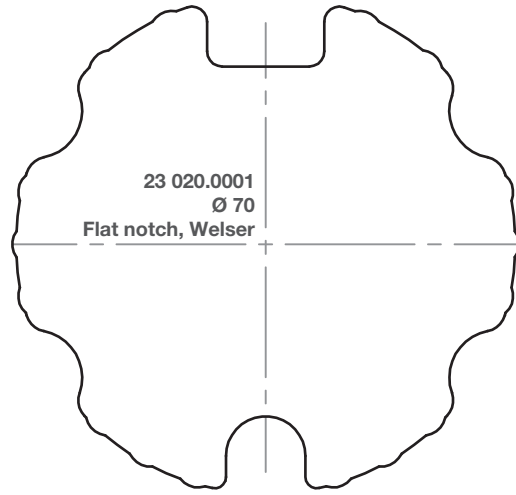
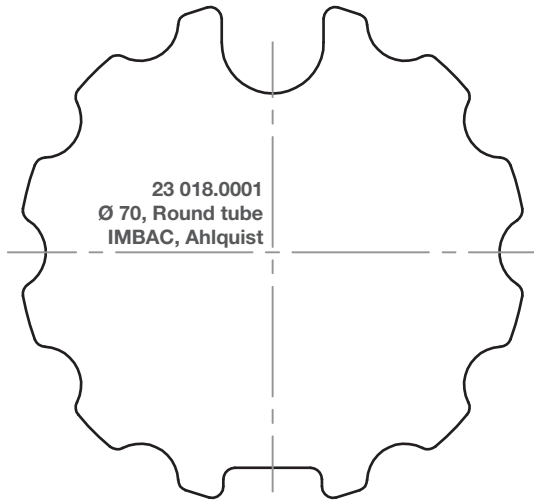

RevoLine
S + M

RevoLine
L RH / L NHK

Venetian Blind drives

Solar drives systems
Speciality drives

Radio control systems
Radio sensors

Wired control units
Sensors

Door drives
Door control units

Adapterprofiles

Adapterprofiles

RevoLine M

Notch tubes

Scale 1:1 / Dimensions in millimetres

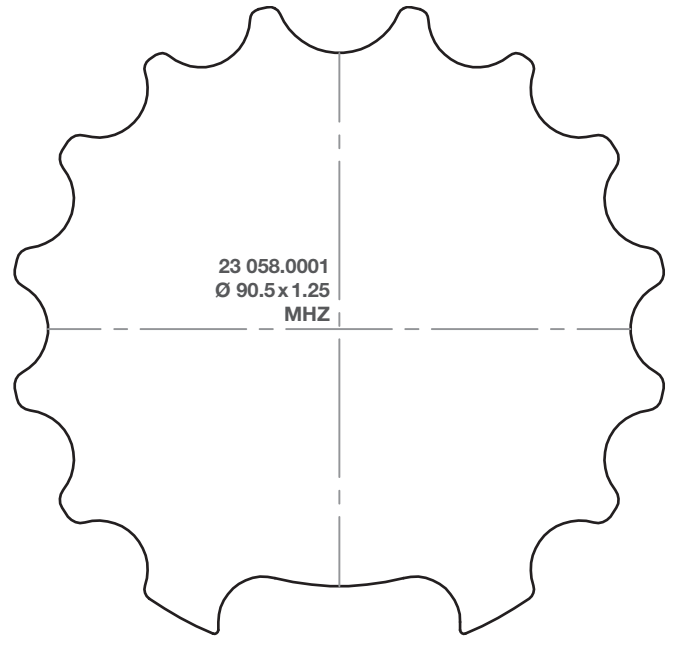
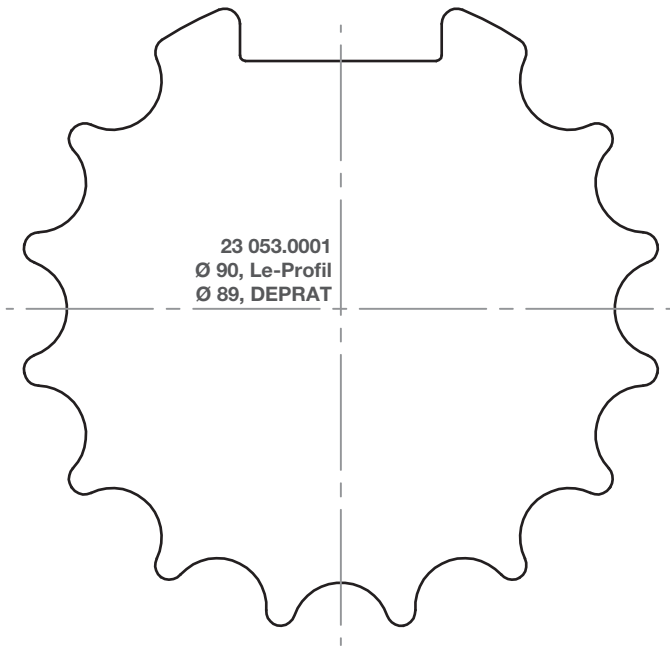
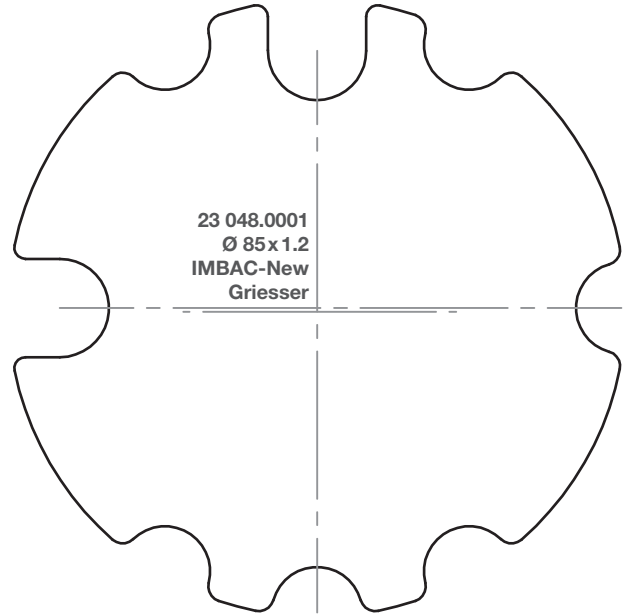
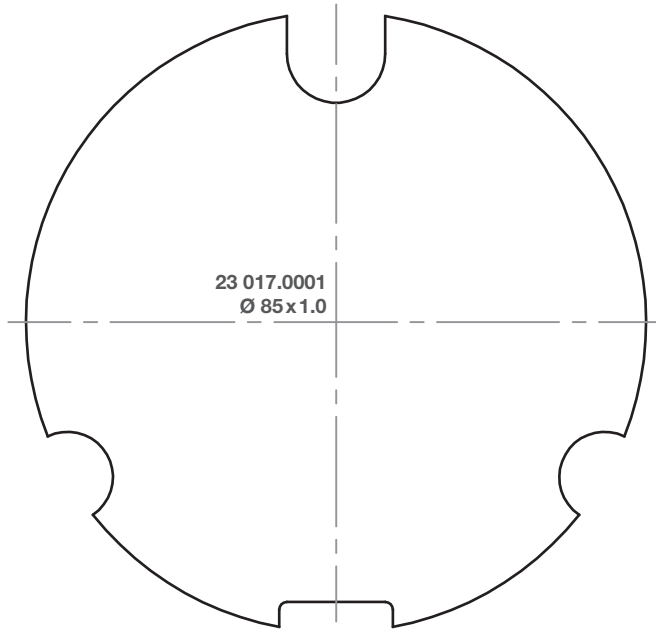

Adapterprofiles

RevoLine M

Round tubes

Scale 1:1 / Dimensions in millimetres

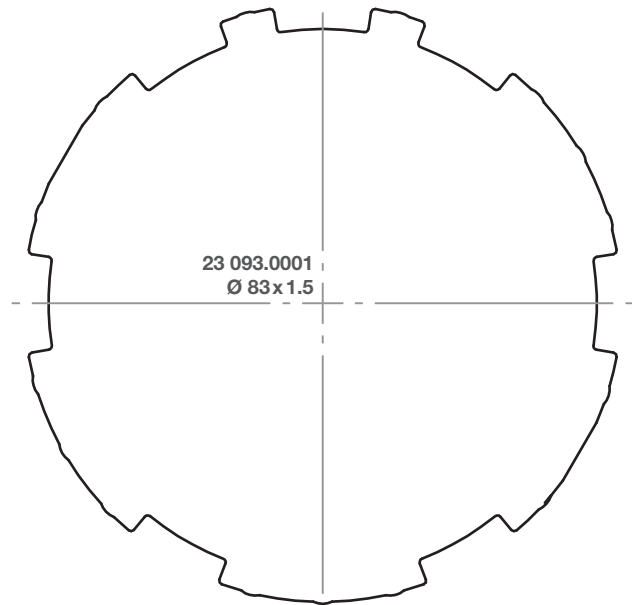
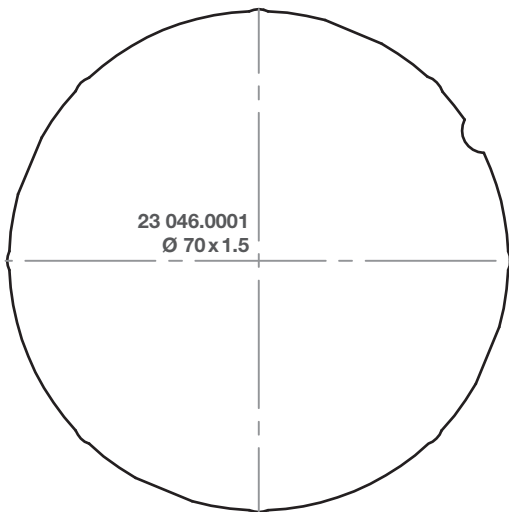
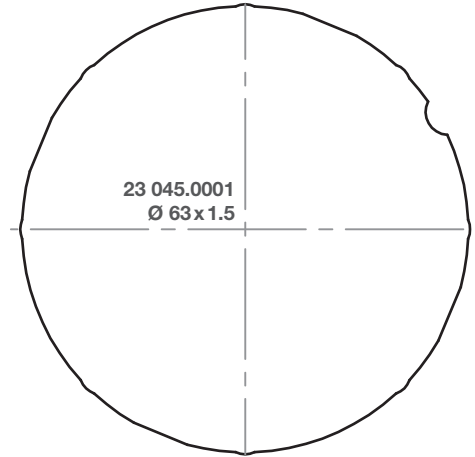
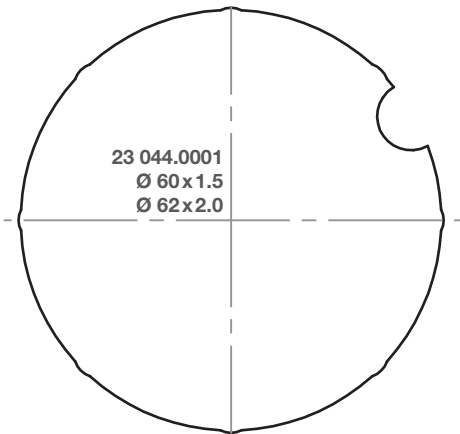
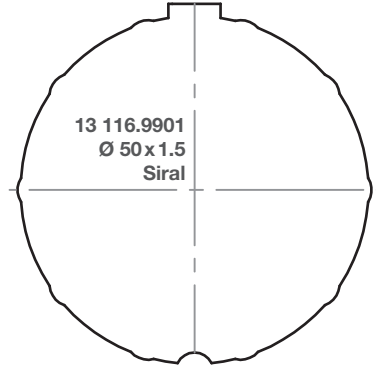
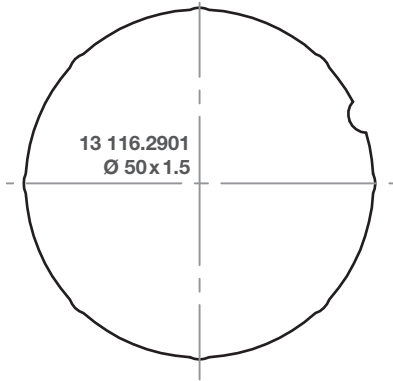

RevoLine
S + M

RevoLine
L RH / L NHK

Venetian Blind drives

Solar drives systems
Speciality drives

Radio control systems
Radio sensors

Wired control units
Sensors

Door drives
Door control units

Adapterprofiles

Adapterprofiles

RevoLine M

Round tubes

Scale 1:1 / Dimensions in millimetres

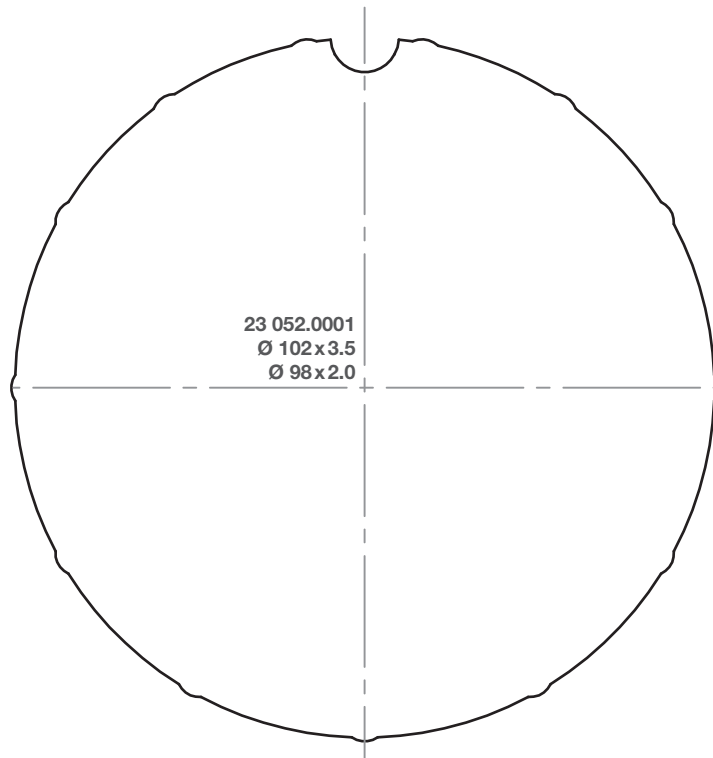
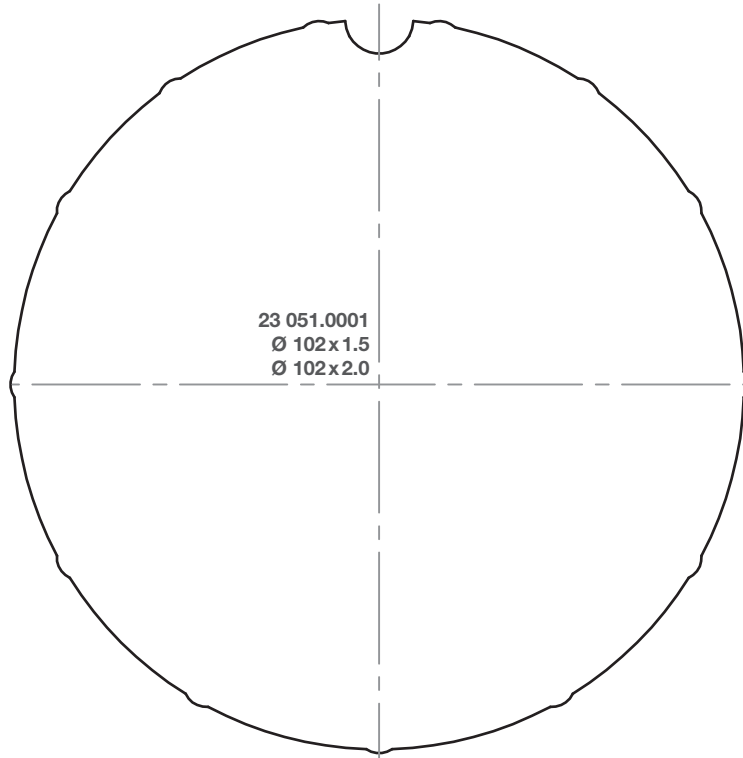

Adapterprofiles

RevoLine M

Profile tubes

Scale 1:1 / Dimensions in millimetres

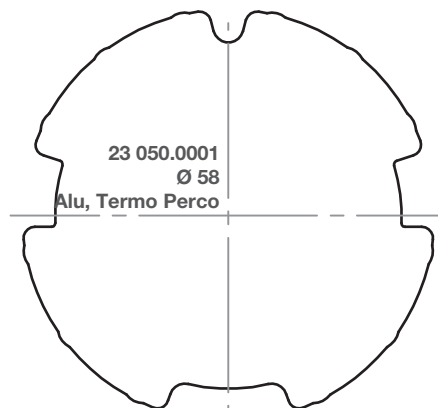
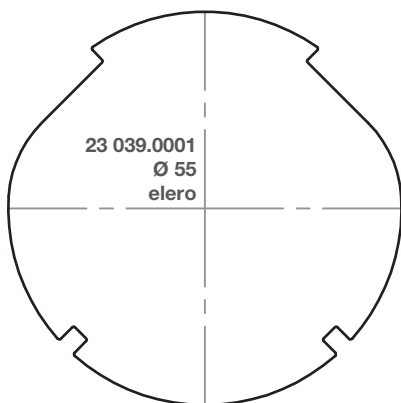
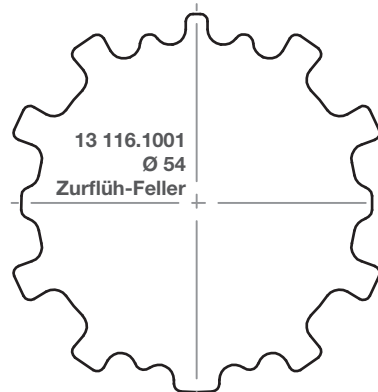
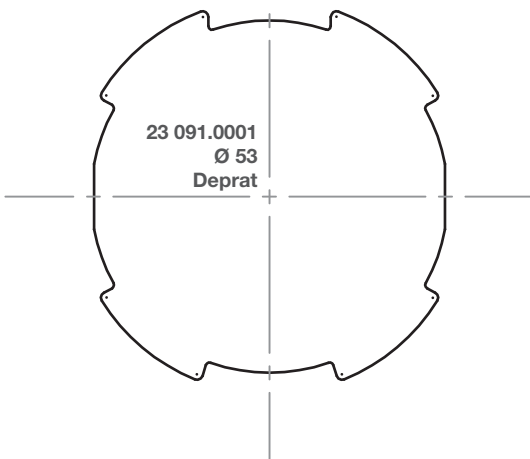
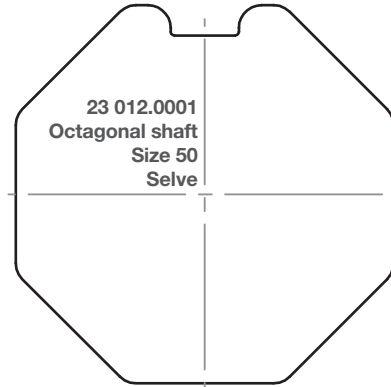
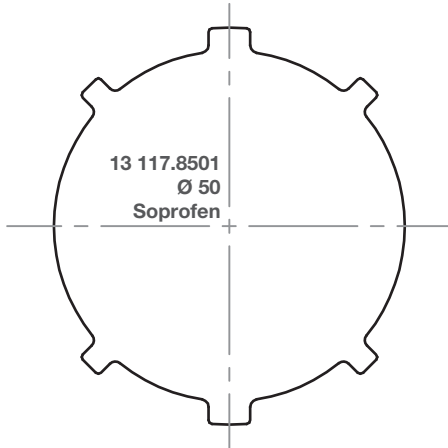

RevoLine
S + M

RevoLine
L RH / L NHK

Venetian Blind drives

Solar drives systems
Speciality drives

Radio control systems
Radio sensors

Wired control units
Sensors

Door drives
Door control units

Adapterprofiles

Adapterprofiles

RevoLine M

Profile tubes

Scale 1:1 / Dimensions in millimetres

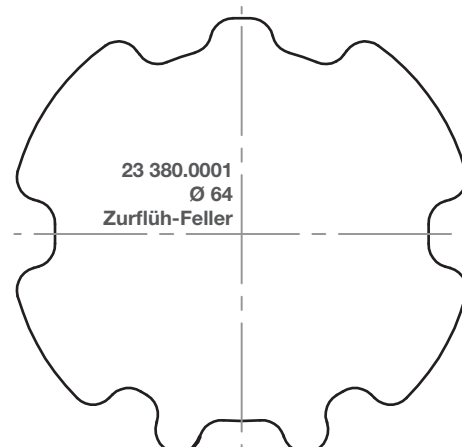
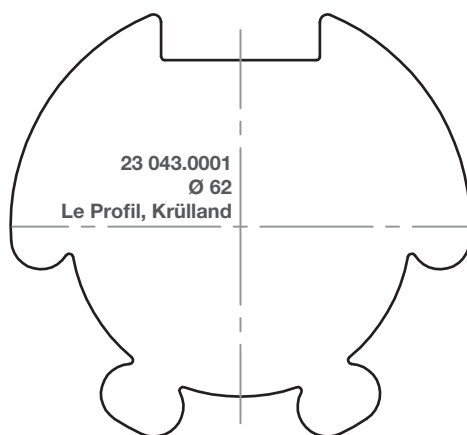
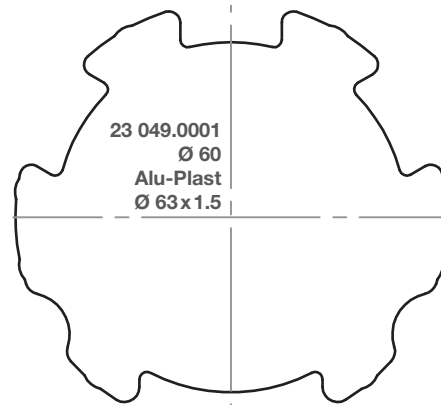
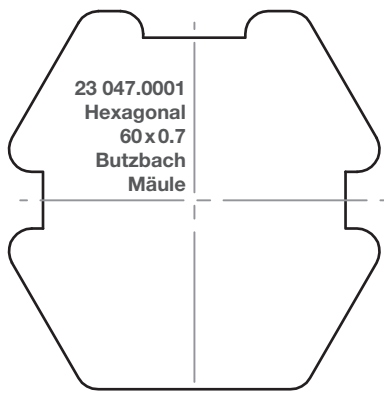
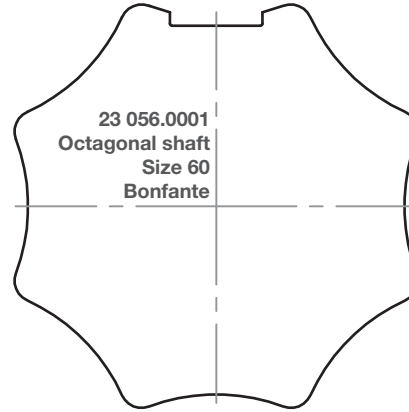
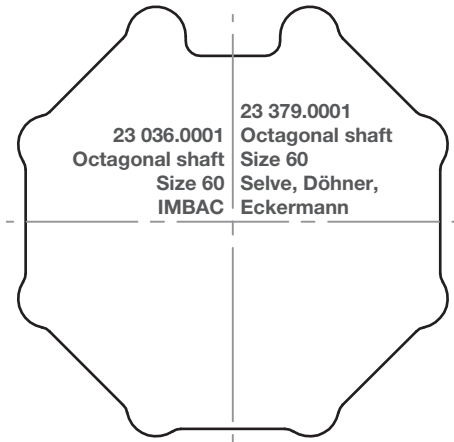

Adapterprofiles

RevoLine M

Profile tubes

Scale 1:1 / Dimensions in millimetres

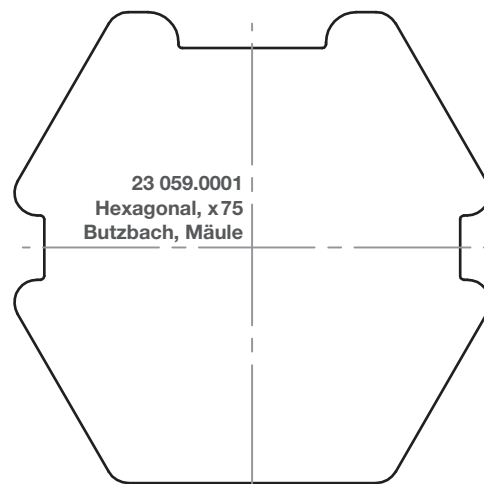
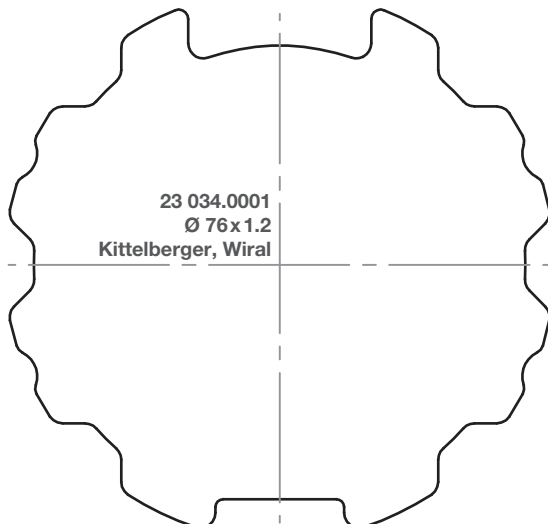
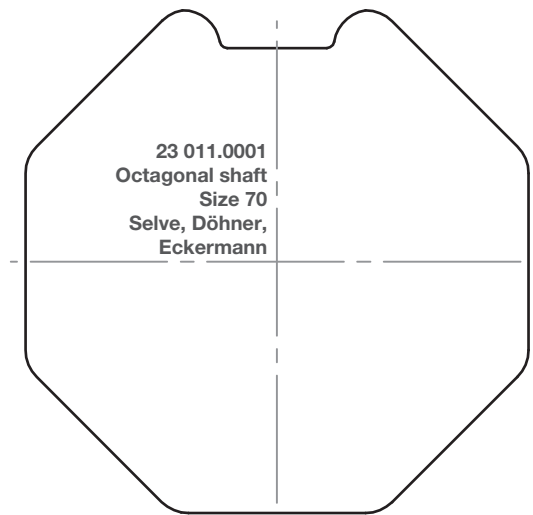
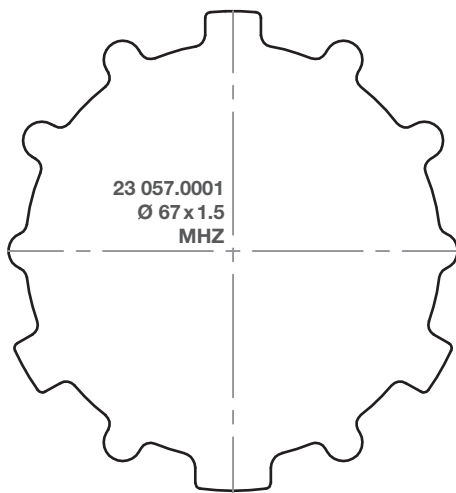
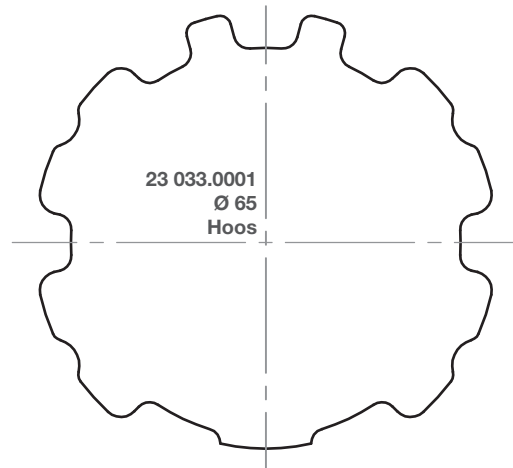
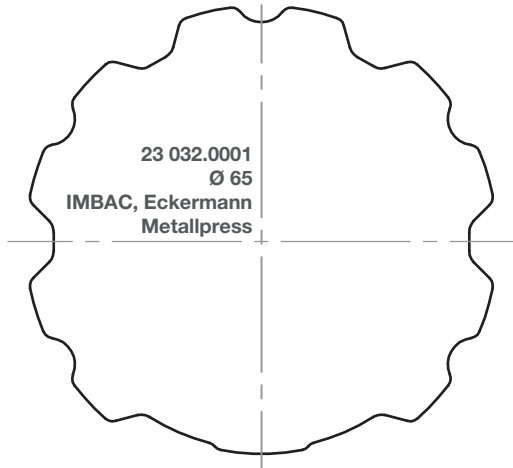

RevoLine
S + M

RevoLine
L RH / L NHK

Venetian Blind drives

Solar drives systems
Speciality drives

Radio control systems
Radio sensors

Wired control units
Sensors

Door drives
Door control units

Adapterprofiles

Adapterprofiles

RevoLine M

Profile tubes

Scale 1:1 / Dimensions in millimetres

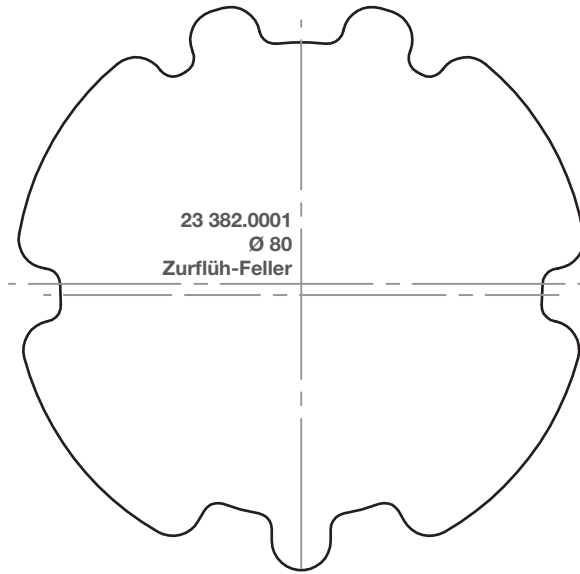
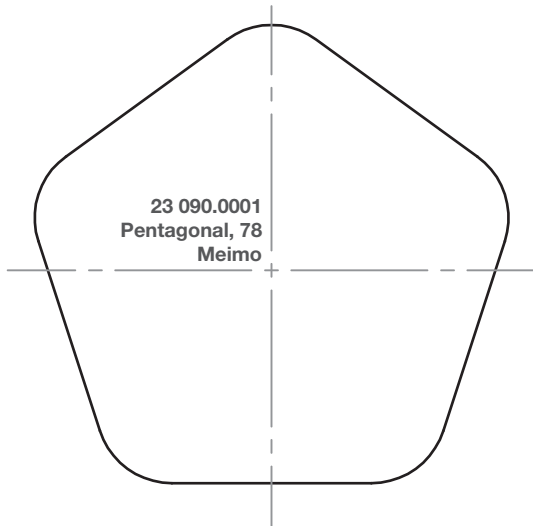

Adapterprofiles

RevoLine L RH / NHK

Round tubes

Scale 1:1 / Dimensions in millimetres

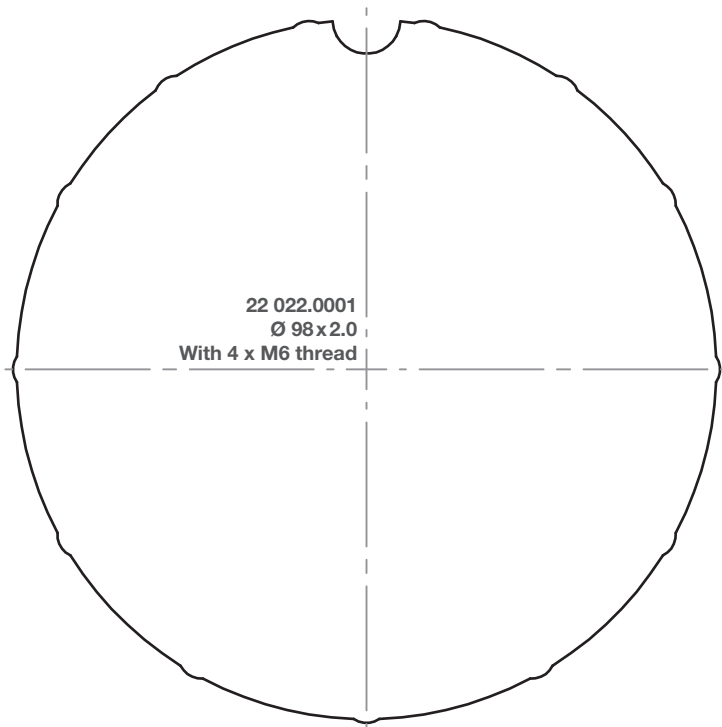
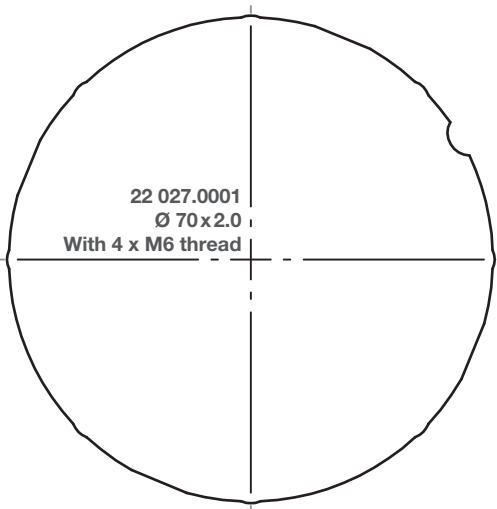
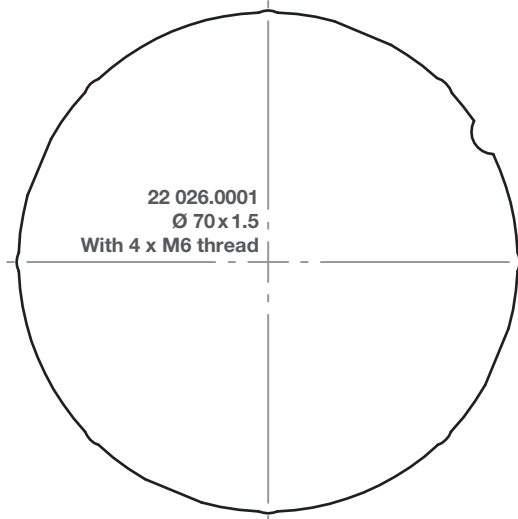
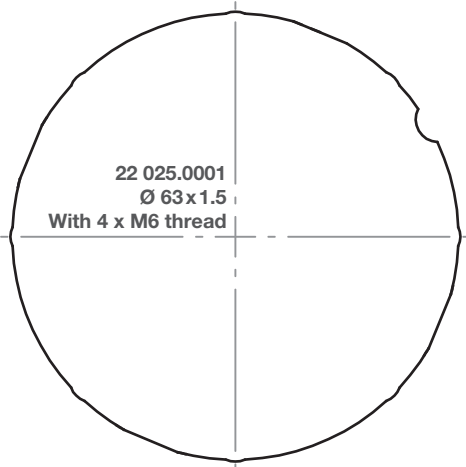

RevoLine
S + M

RevoLine
L RH / L NHK

Venetian Blind drives

Solar drives systems
Speciality drives

Radio control systems
Radio sensors

Wired control units
Sensors

Door drives
Door control units

Adapterprofiles

Adapterprofiles

RevoLine L RH / NHK

Round tubes

Scale 1:1 / Dimensions in millimetres

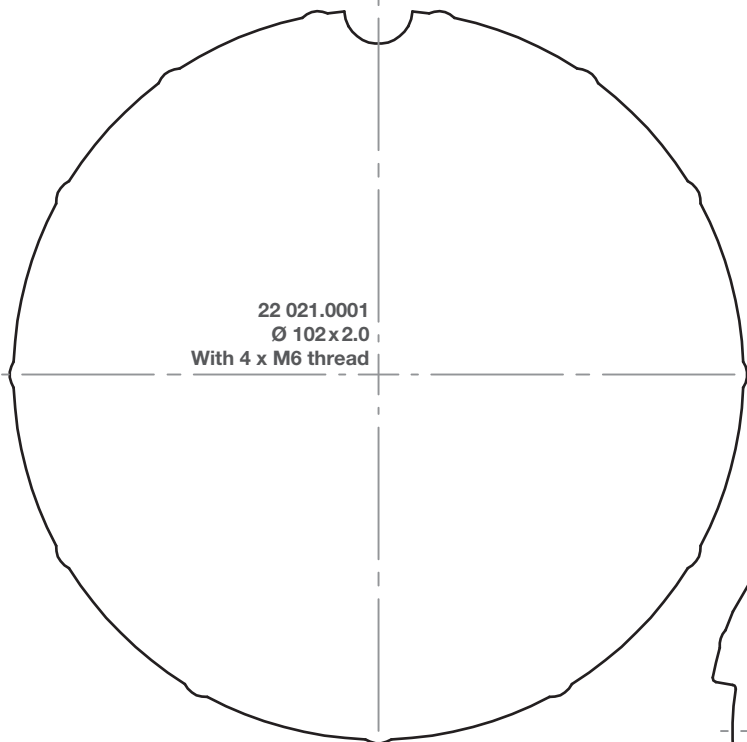

22 021.0001
Ø 102x2.0
With 4 x M6 thread

This technical drawing shows a circular adapter profile with a diameter of 102 mm and a wall thickness of 2.0 mm. It features four M6 threaded holes. The drawing is a half-profile, with a vertical dashed centerline and a horizontal dashed line through the center. The top edge has a small notch.

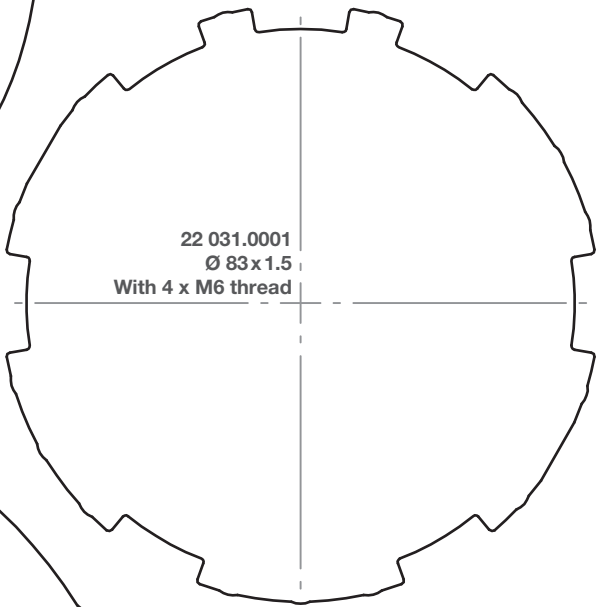

22 031.0001
Ø 83 x 1.5
With 4 x M6 thread

This technical drawing shows a circular adapter profile with a diameter of 83 mm and a wall thickness of 1.5 mm. It features four M6 threaded holes. The drawing is a half-profile, with a vertical dashed centerline and a horizontal dashed line through the center. The top edge has a small notch.

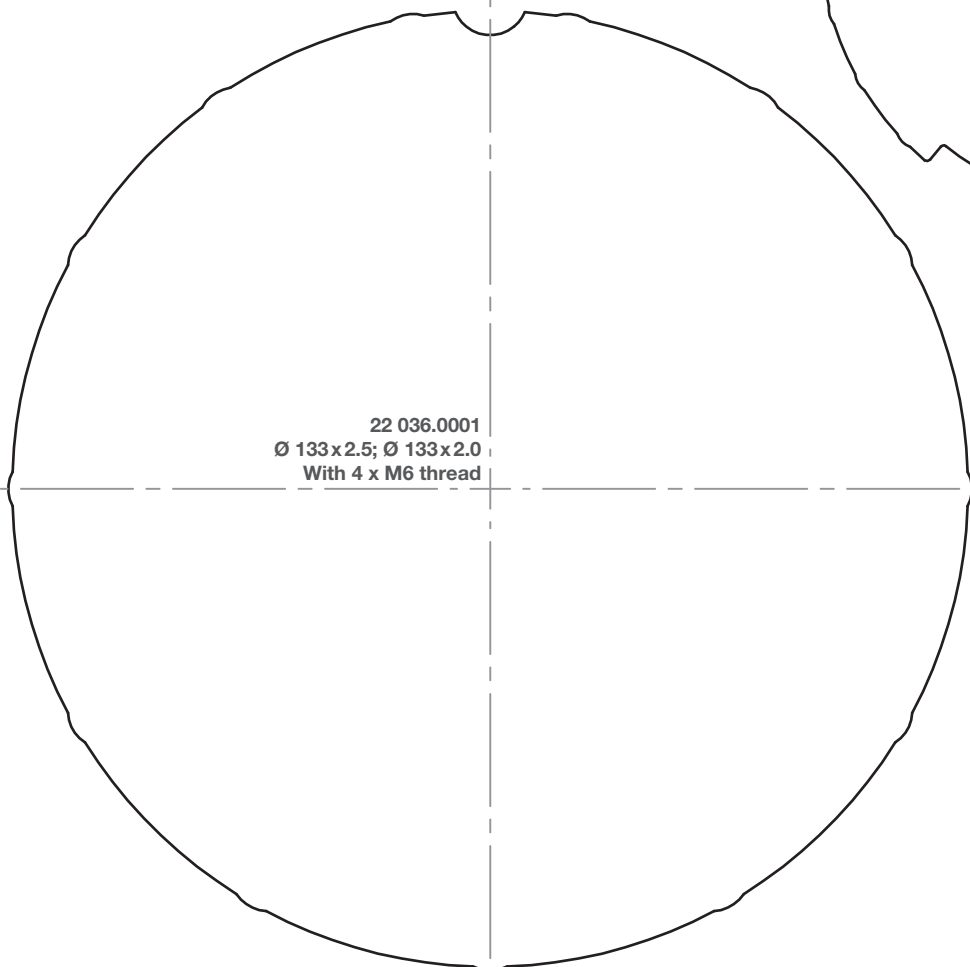

22 036.0001
Ø 133x2.5; Ø 133x2.0
With 4 x M6 thread

This technical drawing shows a circular adapter profile with an outer diameter of 133 mm and a wall thickness of 2.5 mm, and an inner diameter of 133 mm and a wall thickness of 2.0 mm. It features four M6 threaded holes. The drawing is a half-profile, with a vertical dashed centerline and a horizontal dashed line through the center. The top edge has a small notch.

Adapterprofiles

RevoLine L RH / NHK

Profile tubes

Scale 1:1 / Dimensions in millimetres

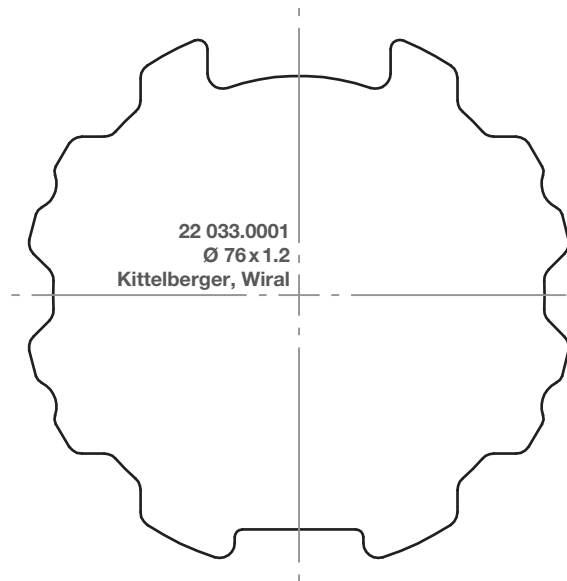
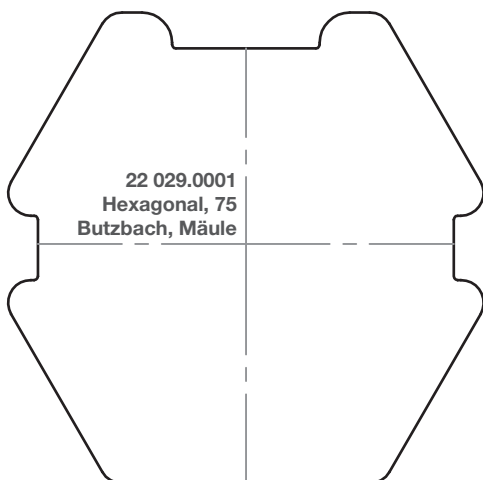
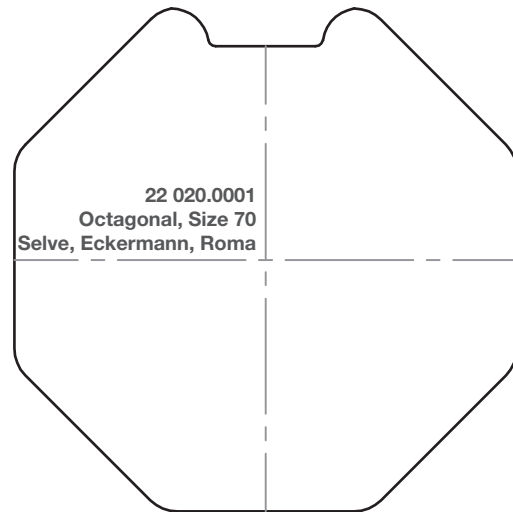
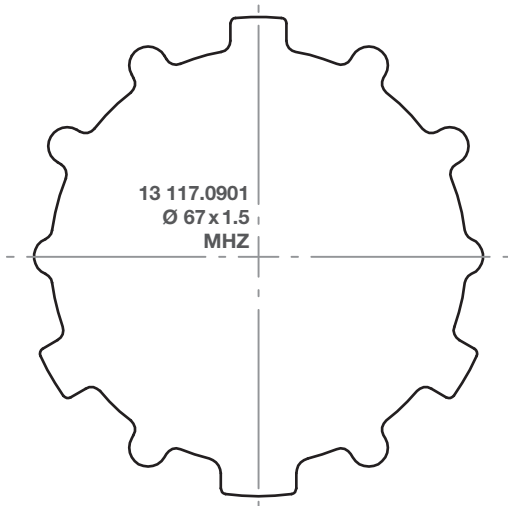

RevoLine
S + M

RevoLine
L RH / L NHK

Venetian Blind drives

Solar drives systems
Speciality drives

Radio control systems
Radio sensors

Wired control units
Sensors

Door drives
Door control units

Adapterprofiles

Adapterprofiles

RevoLine L RH / NHK

Profile tubes

Scale 1:1 / Dimensions in millimetres

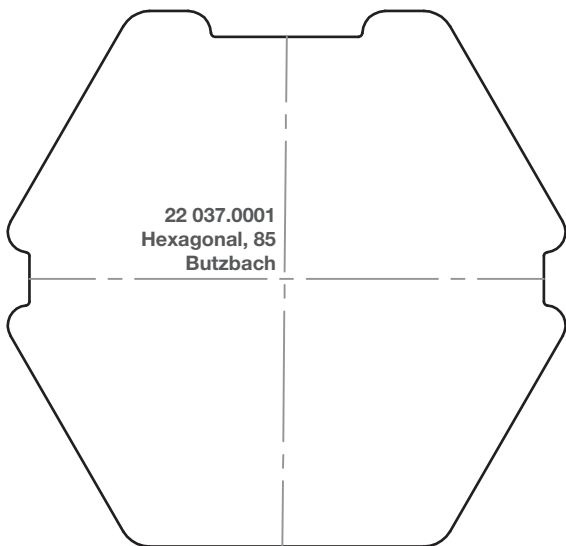
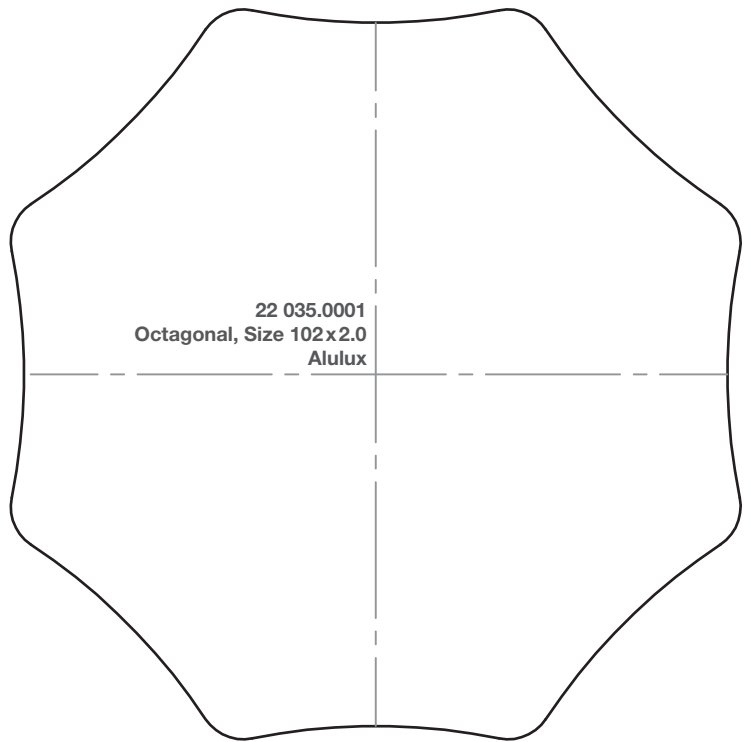
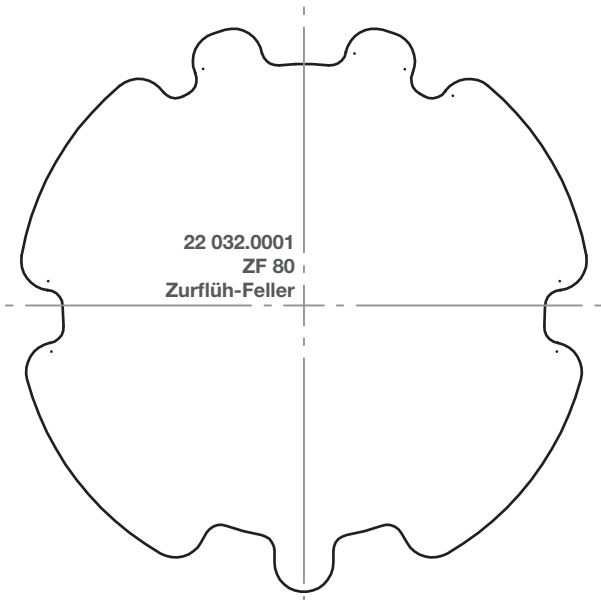

Adapterprofiles

RevoLine L RH / NHK

Profile tubes

Scale 1:1 / Dimensions in millimetres

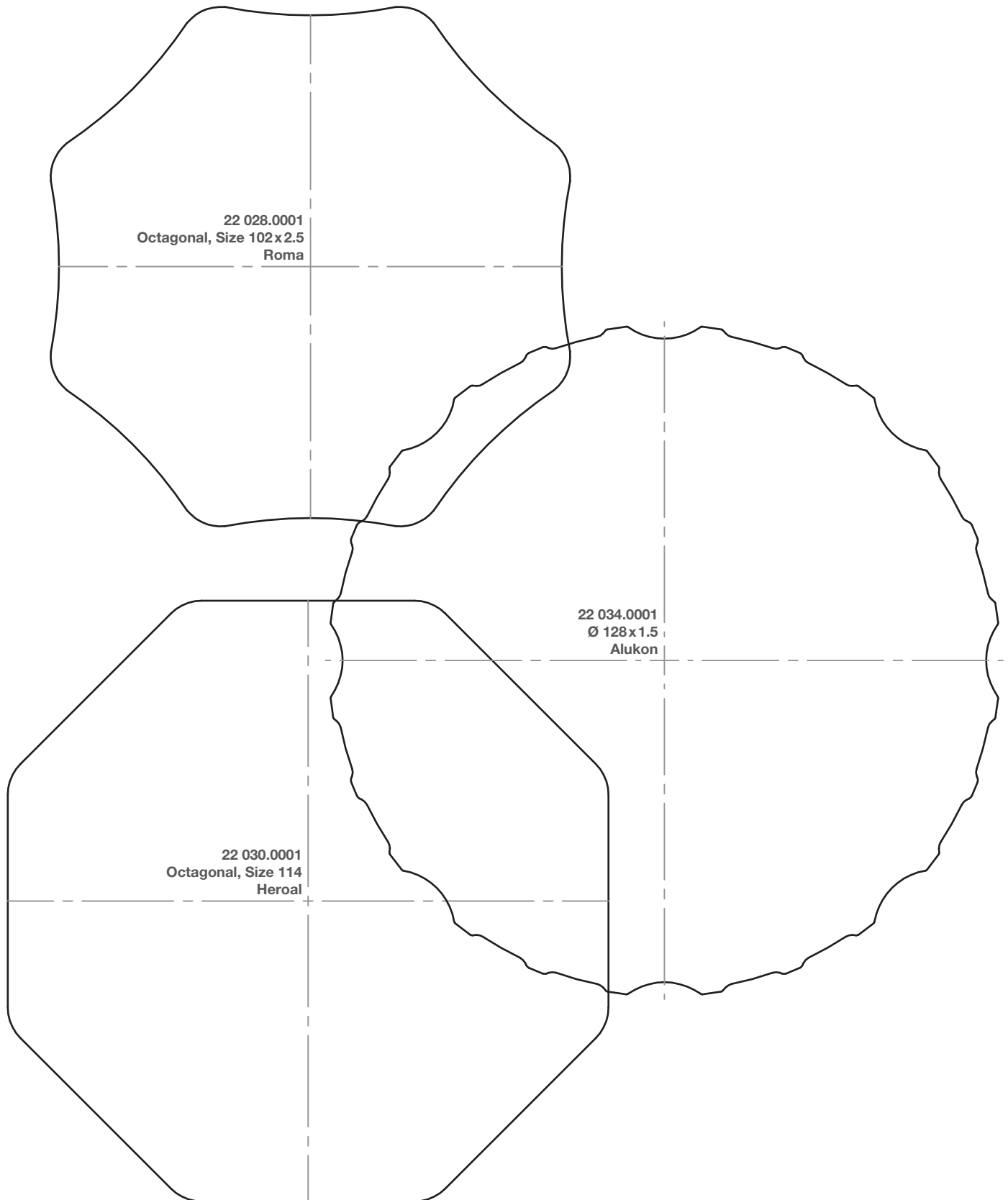

RevoLine
S + M

RevoLine
L RH / L NHK

Venetian Blind drives

Solar drives systems
Speciality drives

Radio control systems
Radio sensors

Wired control units
Sensors

Door drives
Door control units

Adapterprofiles

Adapterprofiles

Type 15

Round tubes

Scale 1:1 / Dimensions in millimetres

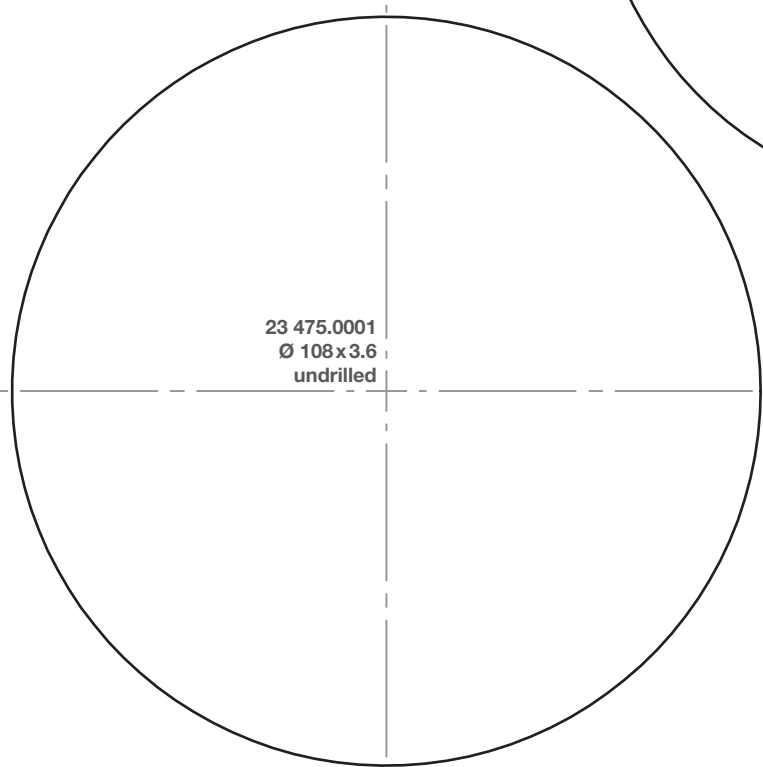
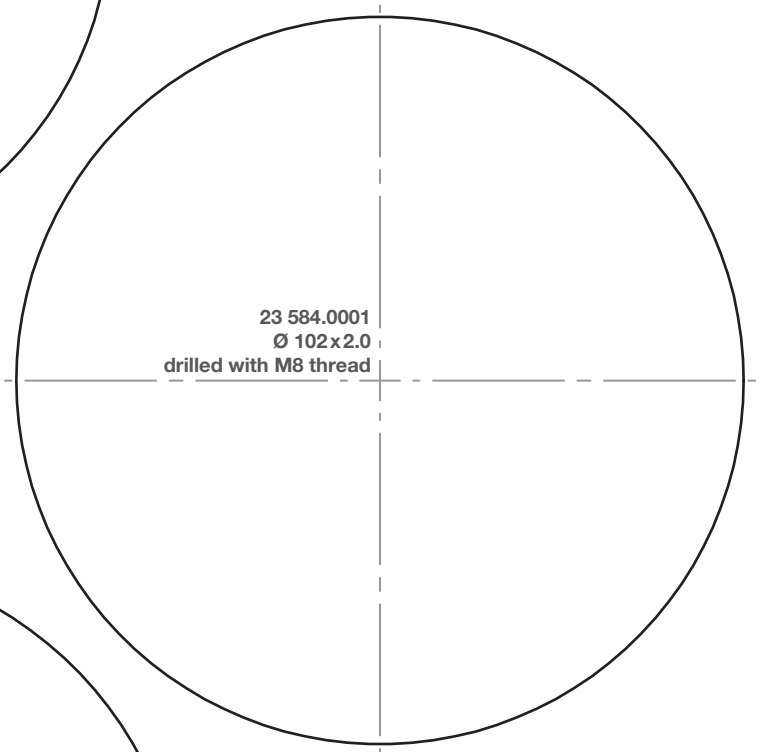
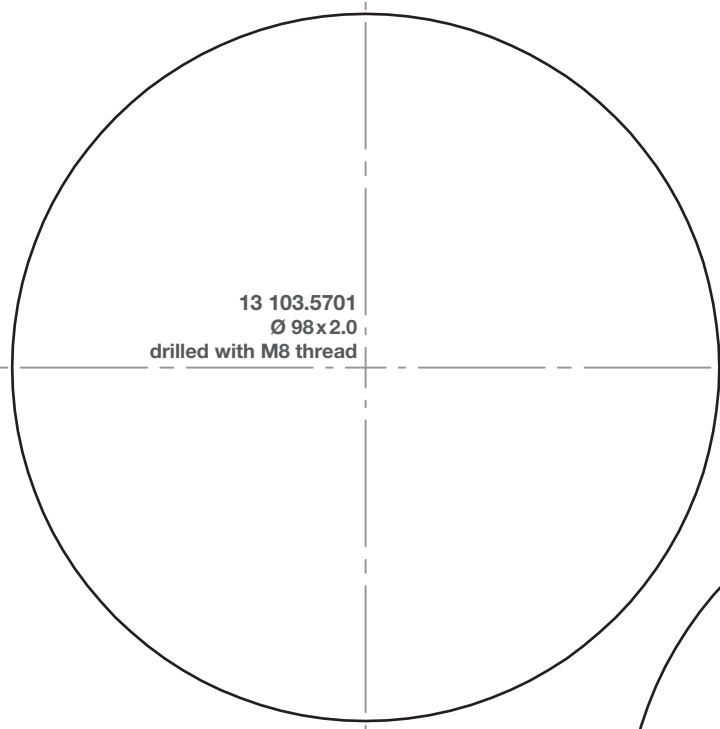

Adapterprofiles

Type 15
Round tubes

Scale 1:1 / Dimensions in millimetres

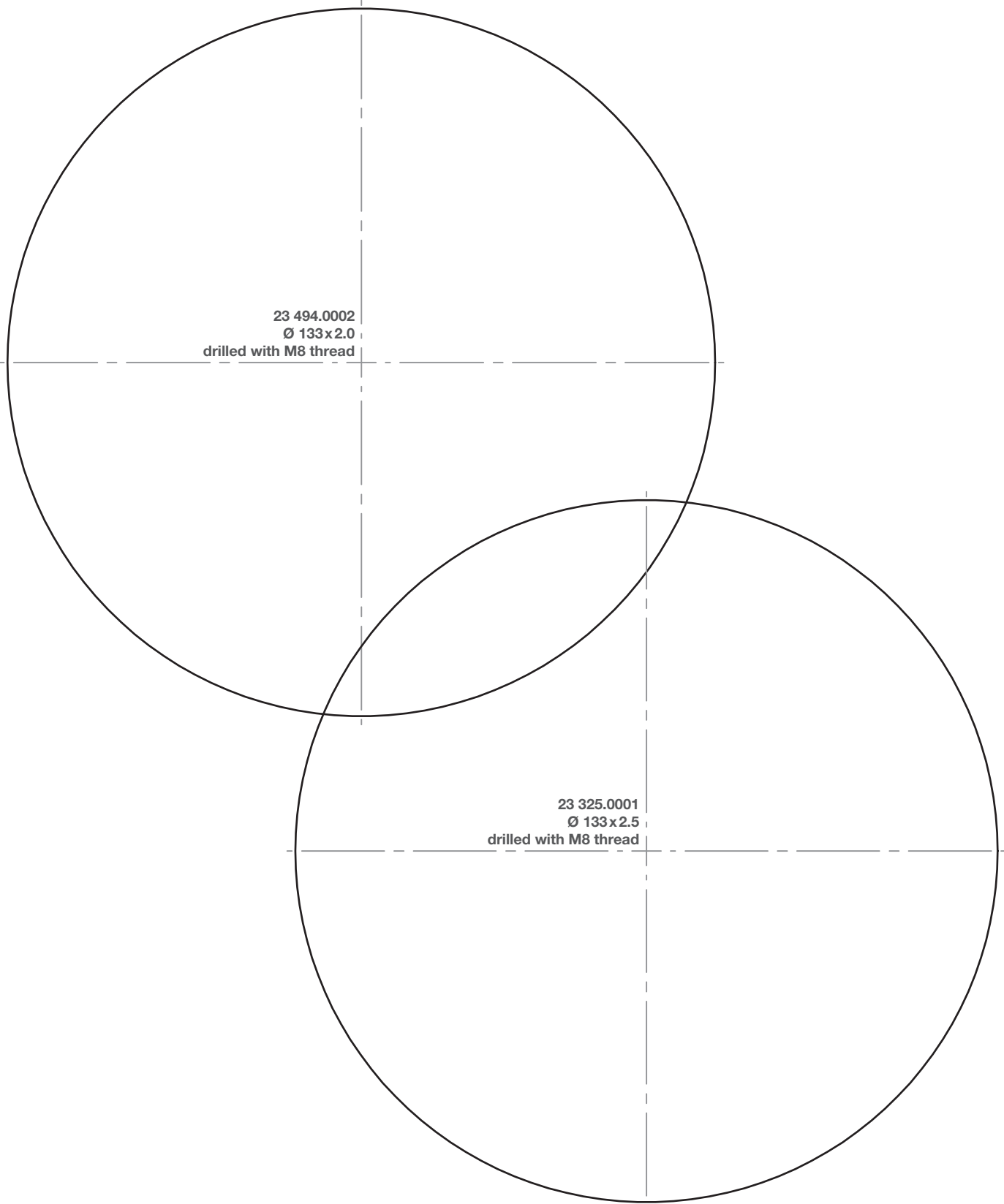

RevoLine
S + M

RevoLine
L RH / L NHK

Venetian Blind drives

Solar drives systems
Speciality drives

Radio control systems
Radio sensors

Wired control units
Sensors

Door drives
Door control units

Adapterprofiles

Adapterprofiles

Type 15
Round tubes

Scale 1:1 / Dimensions in millimetres

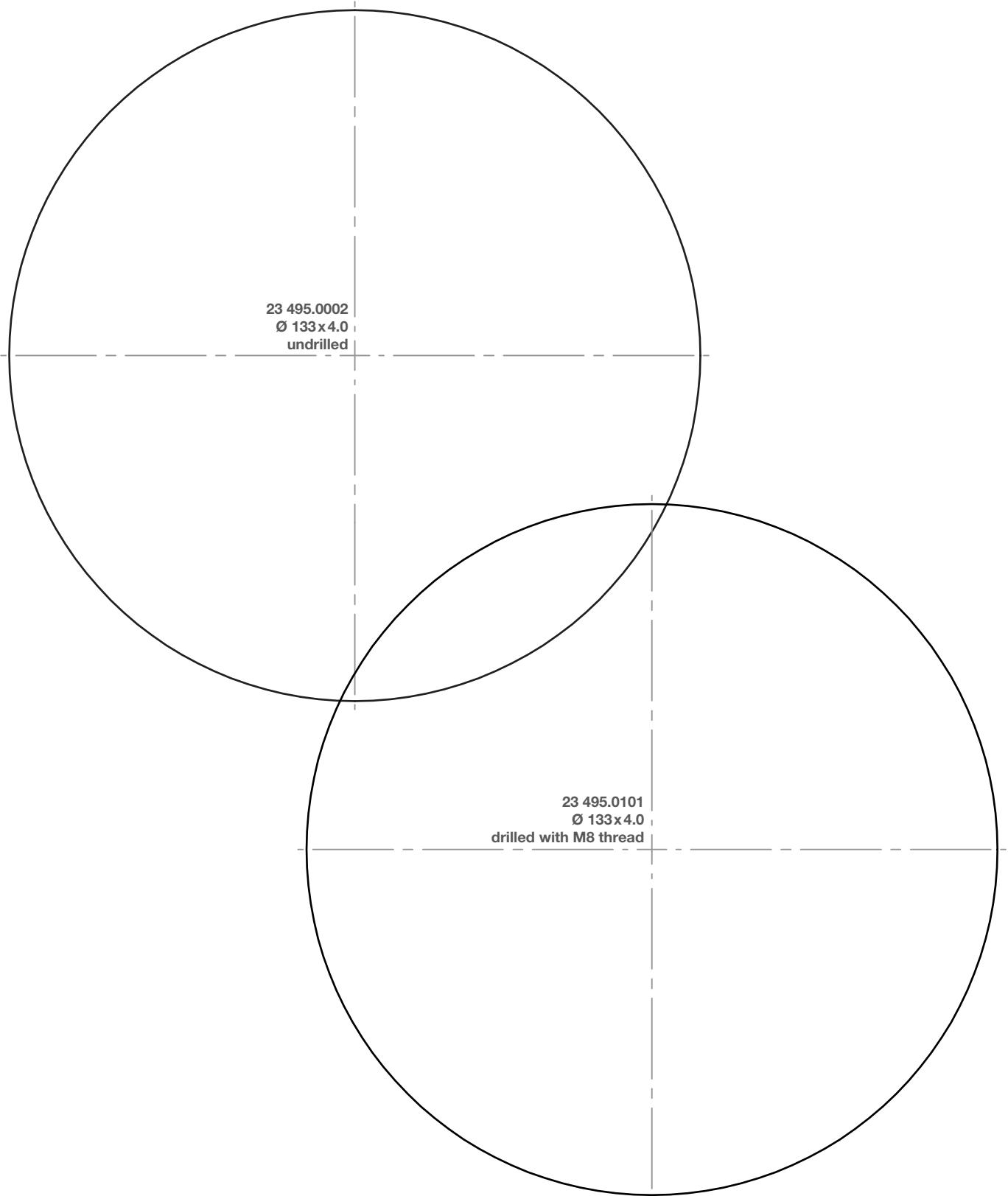

Adapterprofiles

Type 15
Round tubes

Scale 1:1 / Dimensions in millimetres

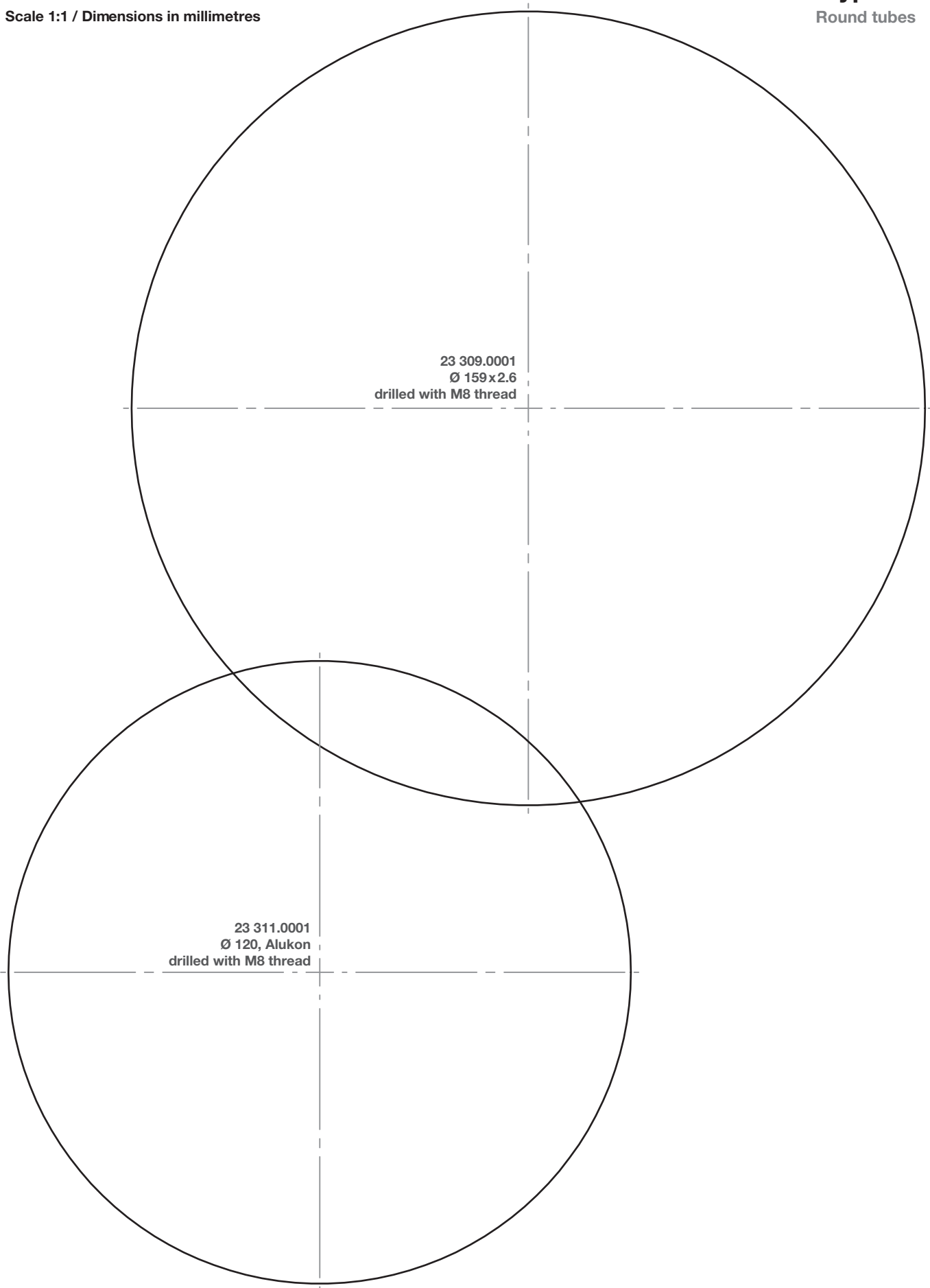

RevoLine
S + M

RevoLine
L RH / L NHK

Venetian Blind drives

Solar drives systems
Speciality drives

Radio control systems
Radio sensors

Wired control units
Sensors

Door drives
Door control units

Adapterprofiles

Adapterprofiles

Type 15
Round tubes

Scale 1:1 / Dimensions in millimetres

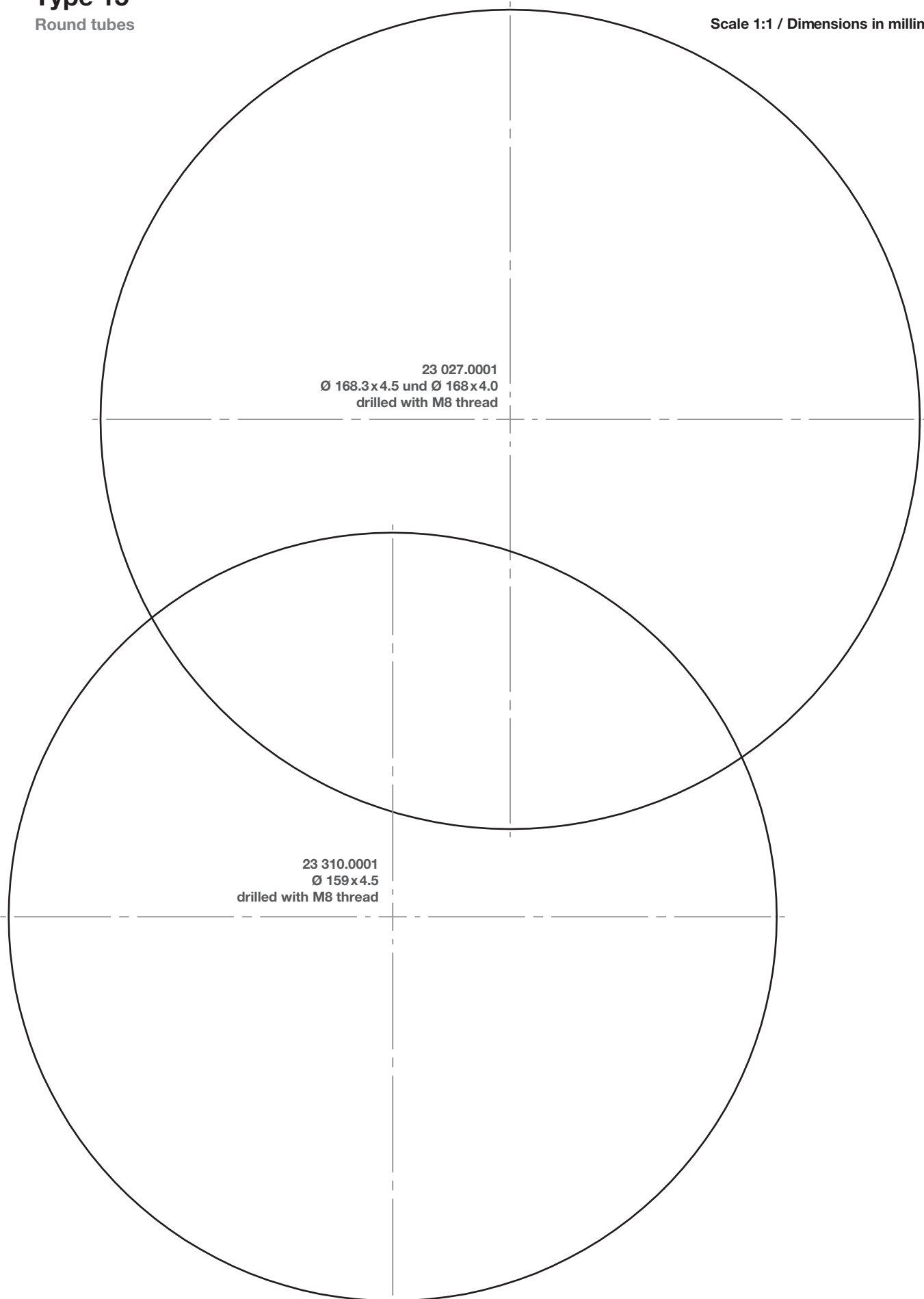

Adapterprofiles

Type 15
Profile tubes

Scale 1:1 / Dimensions in millimetres

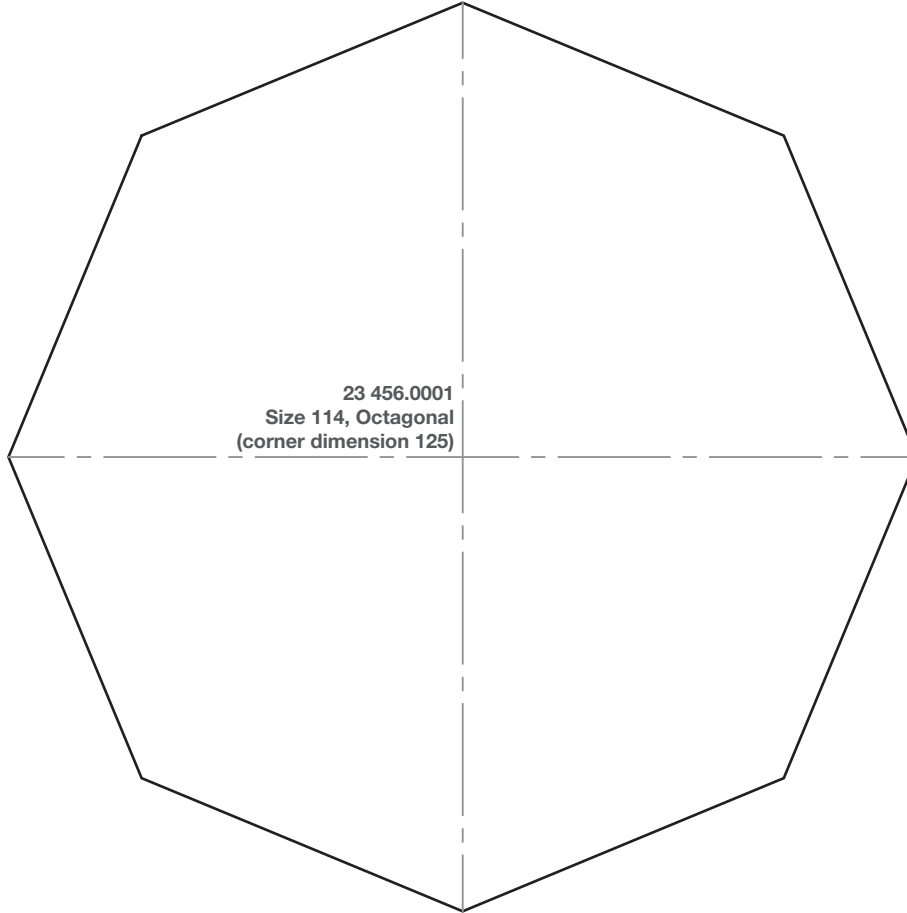

RevoLine
S + M

RevoLine
L RH / L NHK

Venetian Blind drives

Solar drives systems
Speciality drives

Radio control systems
Radio sensors

Wired control units
Sensors

Door drives
Door control systems

Adapterprofiles

Selection table for determining the suitable drive by the rated torque

Determine the required rated torque of the drive based on the system data!

Roller shutters

RoTop / RoTop-868 VariEco / VariEco-868

Rated torque of drive	Winding shaft, octagonal	Roller shutter height / rod thickness (mm)					
		1.5 m			2.5 m		
		8	11	14	8	11	14
(Nm)	(mm)	(kg)					
5	40	14	-	-	12	-	-
8	40	22	-	-	19	-	-
12	40	33	-	-	28	-	-
6	60	-	13	12	-	11	10
7	60	-	16	14	-	13	12
10	60	-	22	20	-	19	17
12	60	-	25	24	-	22	20
20	60	-	43	40	-	37	34
30	60	-	65	60	-	56	51
40	60	-	86	80	-	75	68
50	60	-	108	100	-	93	85
40	70	-	-	74	-	-	64
60	70	-	-	110	-	-	97
80	70	-	-	147	-	-	129
100	70	-	-	184	-	-	161
120	70	-	-	221	-	-	193

The specified values take into account 15% friction.

Textile sun protection

SunTop / SunTop-868 VariEco / VariEco-868

Rated torque of drive	Round/Notch shaft Ø			Traction force on the shaft			
	(Nm)	(mm)			(kg)		
1.5	42				7		
3	42				14		
5	42				24		
8	42				38		
12	42				57		
6	50	78	85	24	15	14	
7	50	78	85	28	18	16	
10	50	78	85	40	26	24	
12	50	78	85	48	30	28	
20	50	78	85	80	51	47	
30	-	78	85	-	77	71	
40	-	78	85	-	103	94	
50	-	78	85	-	128	118	
40	-	78	85	-	103	94	
60	-	78	85	-	154	141	
80	-	78	85	-	205	188	
100	-	78	85	-	256	235	
120	-	78	85	-	308	282	

Roller shutters

VariEco M NHK

Rated torque	Winding shaft, octagonal	Roller shutter height / rod thickness (mm)			
		1.5 m		2.5 m	
		11	14	11	14
(Nm)	(mm)	(kg)			
20	60	43	40	37	34
30	60	65	60	56	51
40	60	86	80	75	68
50	60	108	100	93	85

The specified values take into account 15% friction.

Awnings and roller blinds

VariEco M NHK

Torque	Speed	Shaft Ø	Tensile force at the shaft
(Nm)	(Upm)	(mm)	(kg)
20	14	78	51
		85	47
30	14	78	77
		85	71
40	14	78	103
		85	94
50	14	78	128
		85	118

Drives for marquisolettes, conservatory awnings, fabric tension systems etc. must be determined separately for each individual system.

Important note:
Observe the permissible load of the winding shaft and the permissible size of the blind. These values are guide values! No liability can be accepted! You can obtain the data from the respective manufacturer. For an individual drive calculation, we recommend our drive calculation programme at www.elero.com.

Selection table for determining the suitable drive by the rated torque

Determine the required rated torque of the drive based on the system data!

Roller shutters and doors

Type 15 W / Type 15 W NMA

Torque (Nm)	Shaft Ø (mm)	Nominal rod thickness (mm)	Maximum blind weight for a rolling door/shutter height in m up to		
			2.5	3.5	5.0
120	133	19	138	130	117
	133	23	131	123	109
	168	19	115	113	117
	168	23	114	108	101
150	133	19	172	162	146
	133	23	164	154	137
	168	19	144	141	133
	168	23	142	135	126
180	133	19	206	194	176
	133	23	196	185	164
	168	19	172	169	160
	168	23	170	162	151
230	133	19	264	248	224
	133	23	251	236	203
	168	19	220	216	204
	168	23	218	207	193
300	133	19	344	324	293
	133	23	327	308	273
	168	19	287	281	266
	168	23	284	270	252

This data refer to the complete roller shutter/door in kg, with 15% allowance for friction. The friction can be greater due to additional door seals, wind loads etc. Please make any necessary corrections.

Calculation of the average stroke speed in cm/sec.:

$$V_m = \frac{D + d \cdot 3.14 \cdot n}{2 \cdot 60}$$

V_m = average stroke speed in cm/sec.
 D = bale diameter in cm.
 d = tube diameter in cm.
 n = revolutions per min.

These values are guide values. No liability can be accepted!

Venetian blinds

JA Soft/JAR Soft

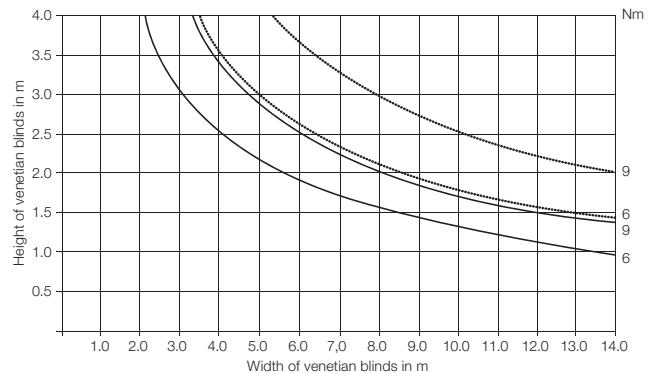

— Slat flanged; Slat without edging

JAe/JAdk/JA NHK/JARdk

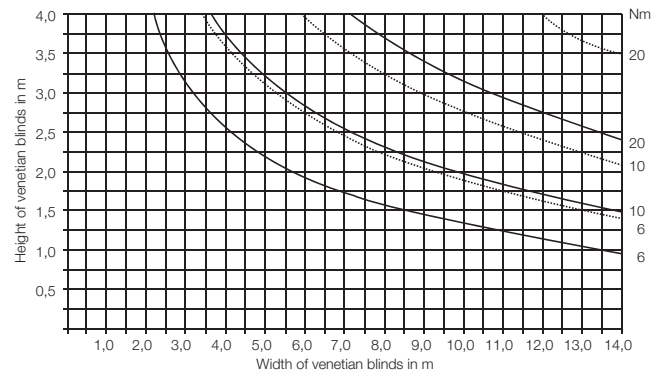

— Slat flanged; Slat without edging

Calculation basis	Slat with edging	Slat without edging
Width per slat (mm)	60 - 90	50
Winding pulley diameter (mm)	22	
Lift belt thickness (mm)	0.34	
Weight incl. bottom rail (kg/m ²)	2.0	1.2

These values are guide values. No liability can be accepted!

Example for determining the rated torque and drive for a roller shutter:

1. Determining the roller shutter data (example)

- Winding shaft 60, octagonal
- Rod thickness: 14 mm
- Armour data: H 2.20 m x W 2.00 m = 4.4 m²
- Armour weight: 5 kg/m² x 4.4 m² = 22 kg

2. Determining the rated torque of the drive

A rated torque of 20 Nm is determined from the table column 2.50 m/14 mm.

3. Selecting the drive

Now select the corresponding drive type with the determined torque from the example: RolTop M20-868

These values are guide values. No liability can be accepted!

Contact

Australia

Home Automation PTY LTD

5 MAB Eastern Promenade
Tonsley SA 5042
Australia
Tel. +61 8 8374 3466
salesau@niceforyou.com

BENELUX

Nice BENELUX SA/NV

Ambachtenlaan 17
3001 Leuven (Heverlee)
België
Tel. +32 16 38 69 00

Brasil

Nice Limeira | Automação

Tel. +55 19 2113 2727

Nice São Caetano do Sul |

Controle de Acesso e Segurança Eletrônica
Tel. +55 11 2823 8800

Canada

Nice Canada

1380 St Regis Blvd,
Dorval
Quebec H9P 2T5
Canada
Tel. +1 877 888 1116

China

耐氏中国

Nice Shanghai Automatic Control Co Ltd

中国 上海市 奉贤区 南桥镇 沪杭公路
1588号凤创谷2号楼706

Room 706, Bldg 2, No.1588, Huhang High Way,
NanQiao town,Fengxian District,Shanghai
China

Tel. 电话 +86 21 6089 0008
customer.care@niceforyou.com.cn

France

Nice France S.a.S.

ZI Les Paluds 2
305, Avenue de Jouques
CS 61467
13785 Aubagne Cedex
France
Tel. +33 810 004 732
nice-services@niceforyou.com

Poland

Nice Polska Sp. z o.o.

ul. Parzniewska 2a
05-800 Pruszków
Polska
Tel. +48 22 759 41 43
nice.pl@niceforyou.com

Portugal

Nice Portugal

Avenida 25 de Abril 103
Vila Verde
2705-902 Terrugem
Portugal
Tel. +351 21 460 2953

Romania

Nice Romania

Str. Libertatii, nr. 5
Apahida, jud. Cluj
Napoca
România
Tel. +40 264 453 127

Russia

АО «Найс Автоматика для Дома»

Центральный офис :
143006, Московская область, г.
Одинцово, ул. Транспортная, д. 2
Тел. +7 495 989 76 92
Info.ru@niceforyou.com
www.niceforyou.com

Singapore

elero Singapore Pte. Ltd.

63 Ubi Ave 1, #04-05
408937 Ubi
Singapore
Tel. +65 68 99 90 62
kelvin.quek@elero.com

South Africa

Nice Group South Africa (Pty) Ltd.

15 Nelson Street
Observatory
Cape Town
South Africa
Tel. +27 21 4040 800
za@niceforyou.com
www.niceforyou.com/za

Spain

Nice Automatismos España S.A.

Poligono Industrial Expansion Nr. 6
C/ Puerto Navafria, 19-21
28935 - Mostoles
España
Tel. +34 9 1616 3300

Sweden

Nice Home & Building Automation Nordics AB

Ridspögatan 10
SE-21377 Malmö
Sweden
Tel. +46 40 545 726

Turkey

Nice Turkey

Şerifali Mah.
Söyleşi Sok. No: 17
Ümraniye İstanbul
Türkiye
Tel. +90 216 644 7036

United Arab Emirates

Nice U.A.E.

Warehouse RA08EA07
Near Roundabout 8
PO BOX 261579
Jebel Ali Freezone
Dubai U.A.E.
Tel. +971 4 8808 303

United Kingdom

Nice UK Ltd.

Automation House
Hamilton Road
Sutton in Ashfield
Nottinghamshire NG17 5LD
United Kingdom
Tel. +44 16 2355 8086

Schlierbach plant contact

You can reach our contact persons at the following extensions during business hours:

By phone:

Sales +49 7021 9539-567

Outside our business hours, you can reach us as follows:

By phone:

Mail box +49 7021 9539-0

By e-mail:

Enquiries Anfrage@elero.de

Orders Bestellung@elero.de

You can reach our technical service during German business hours as follows:

By phone:

English-speaking +49 7021 9539-550

German-speaking +49 7021 9539-555

By e-mail:

Technik@elero.de

Visit us at our

website elero.com

youtube chanel [youtube.com/eleroGmbH](https://www.youtube.com/eleroGmbH)



Get the manual you need under

elero.com/downloads-service/downloads/

or download our manuals app  from the stores

<https://apps.apple.com/app/anleitungen/id1199088937>



<https://play.google.com/store/apps/details?id=de.elero.anleitungen>



Information

The information in the catalogue refers to the current production status of the devices. We reserve the right to make changes to the technology and design; colour deviations are possible and due to printing technology. No liability is accepted for printing errors and mistakes. elero also reserves the right to change both the product-related technical and business documents as well as their products at any time.

The dimensions listed are in millimetres unless otherwise stated. For further information on our products, please also refer to the technical documentation and instructions for use enclosed with them. Our products may be processed only by authorised specialists; dangers and risks that are not insignificant may otherwise arise in the event of improper installation.

Terms and conditions of sale

§ 1 Scope of validity

- Our terms and conditions of sale shall apply exclusively. They shall apply to this and all future transactions with the customer, unless expressly agreed otherwise between the parties. We do not accept any conflicting or deviating terms and conditions of the customer. The terms and conditions of business of the customer or third parties shall not apply even if their validity is not objected to in individual cases or if reference is made to a letter that contains or refers to the terms and conditions of business of the customer or a third party. Exceptions must be agreed in writing between the parties.
- Unless otherwise stated in the terms of the contract, the terms and definitions of INCOTERMS 2010 shall apply. P

§ 2 Conclusion of contract

- Our quotations are not binding. Likewise, technical descriptions and other details in brochures and other information are not binding unless they are expressly indicated as binding.
- We reserve the copyright and proprietary rights to all samples, brochures, technical descriptions, calculations and other documents. They may be made accessible to third parties only with prior written consent.
- The acceptance declaration and all confirmations must be in writing in order to be valid.
- If the order is to be qualified as a quotation in accordance with § 145 BGB, we can accept this within 12 working days.
- Information in samples, brochures, technical descriptions as well as in public statements on our part, by the manufacturer and their assistants (§ 434, para. 1, p. 3 BGB) is only part of the performance description if it is expressly referred to in the contract.
- With the exception of the managing director and sales management, our (sales) employees are not authorised to make verbal ancillary agreements, make verbal agreements that deviate from these GTC or give verbal assurances that go beyond the content of the written contract.

§ 3 Prices and payment terms

- The agreed prices shall apply. They are "ex works" plus packaging, statutory value added tax, customs duty for export deliveries as well as fees and other public charges including additional expenses such as those for the conclusion of insurance policies. The statutory value added tax shall be disclosed separately in the invoice at the statutory rate on the day of invoicing.
- If the main cost components change before the delivery is supplied, there may be a price increase if the delivery or performance is provided more than four months after signing the contract. The price increase shall take into account the mutual interests of the contracting parties.
- Invoice amounts are due immediately, as net amounts without deduction.
- Any other forms of payment require a special written agreement. Any costs incurred by either side shall be borne by the customer. Payment by bill of exchange is excluded.
- The customer shall have a right of set-off or a right of retention only with respect to undisputed or legally established claims or entitlements.

§ 4 Delivery and cooperation pledges B

- The scope of our delivery obligation results exclusively from the respective contract. We reserve the right to make changes to the design, shape and colour based on technological improvements or the requirements of the legislator insofar as the changes are not substantial or otherwise unreasonable for the customer.
- We are entitled to make partial deliveries if:
 - The partial delivery is usable for the customer within the scope of the contractual intended purpose.
 - The delivery of the remaining ordered goods is ensured and
 - The customer does not incur any significant additional expenses or costs as a result.
- Deliveries shall be made "ex works" unless otherwise agreed in writing between the parties.
- The specified delivery deadlines are always subject to the contractual cooperation of the customer. Prospective deadlines and dates for deliveries and services are always only approximate unless they are promised as "definite". Compliance with our obligation to deliver pre-supposes that the customer fulfils their obligations in a timely and proper manner.
- If we ourselves are not supplied correctly and/or on time although we have placed at least congruent orders with reliable suppliers, we shall be released from our obligation to perform and may withdraw from the contract, provided that the delay in delivery is not only of temporary nature.
- If, after the conclusion of the contract, it becomes apparent that the customer does not offer sufficient guarantee for their ability to pay and that our claim for payment is at risk, we shall be entitled to refuse delivery until the customer has effected the payment or provided security for it. If the payment or provision of security is not made within 12 working days after a request to that effect, we shall be entitled to withdraw from the contract.
- If the customer is in default with acceptance or collection or responsible for a delay in dispatch or delivery, we are entitled – without prejudice to further claims – to demand a lump sum for costs in the amount of the usual local storage costs, irrespective of whether we store the goods on our or a third party's premises. The customer reserves the right to prove that no or less damage has been incurred.

§ 5 Delay in delivery, force majeure, reservation of self-delivery

- elero GmbH shall not be liable for delays or other non-fulfilled contractual obligations if the failures are due to force majeure, i.e. factors beyond our control.
- We are entitled to withdraw from the contract insofar as we do not receive the delivery item despite the prior conclusion of a corresponding purchase contract on our part; our responsibility for intent or gross negligence shall remain unaffected. We shall inform the customer without delay of the unavailability of the delivery item and, if we wish to withdraw, exercise the right of withdrawal without delay; in the event of withdrawal, we shall reimburse the customer for the corresponding withdrawal without delay.
- If the delivery deadline agreed with the customer cannot be met as a result of circumstances beyond our control (in particular operational disruptions of any kind, difficulties in the procurement of materials or energy, transport delays, strikes, lawful lockouts, shortage of manpower, shortage of energy or raw materials, difficulties in obtaining the necessary official permits and/or official measures in our sphere or in the sphere of our suppliers), the delivery period shall be extended by the period of the hindrance plus a reasonable resumption period.
- If the circumstances impeding the delivery still persist one month after expiry of the agreed delivery period, either side may withdraw from the contract. Any further claims due to exceeding the delivery deadline not caused by us intentionally or by gross negligence are excluded; claims for damages shall be limited to the foreseeable damage specific to the contract.

§ 6 Place of performance and transfer of risk

The place of performance for all obligations arising from the contractual relationship is our registered office in 73278 Schlierbach for orders in the field of drive technology and our registered office in 07381 Pößneck for orders in the field of linear technology.

§ 7 Packaging

We shall pack the goods appropriately. The costs for the disposal of transport and sales packaging shall be borne by the customer.

§ 8 Shipment

- If shipment is agreed between the parties, the risk of loss of the delivery item shall be passed on to the customer at the latest when the delivery item is handed over to the forwarding agent, carrier or other third party designated to carry out the shipment. This also applies if partial deliveries have been made and we have provided also other services.
- If the shipment or handover is delayed due to circumstances caused by the customer, the risk shall be passed on to the customer on the day on which the delivery item is ready for shipment and we have notified the customer.
- Any storage costs after the transfer of risk shall be borne by the customer. In the event of storage by us, the storage costs shall amount to 0.5% of the invoice amount of the delivery items to be stored per expired week. We reserve the right to claim and verify further or lower storage costs.
- We shall insure the consignment against theft, breakage, transport, fire and water damage or other risks only at the express request of the customer and at their expense.

§ 9 Material defects

- The customer shall be subject to the statutory obligation to inspect the goods and to give notice of defects in accordance with § 377 of the German Commercial Code (HGB).
- The wear and tear or consumption of batteries (including rechargeable batteries) and other wear products does not constitute a material defect. The legal warranty for the usual, generally expected condition and intended use of these articles is not affected by this. Insofar as we provide a warranty or guarantee for certain products/product groups that goes beyond the statutory liability for defects, in particular by granting an extended period for material replacement free of charge due to defects, this shall not apply to wear and tear or consumable items.
- The customer cannot derive any rights from material defects that do not or only insignificantly impair the value or the suitability for the use recognisable to us.
- If the goods exhibit any material defects when the risk is transferred, we shall be entitled and obliged to rectify the defects. The defects shall be rectified at our discretion by repair or replacement delivery.
- If the rectification of defects fails, does not take place within a reasonable period set by the customer or is refused, the customer shall be entitled to decide whether to withdraw from the contract, demand a reduction of the purchase price corresponding to the defect and value or - within the limits of the following paragraphs - demand damages instead of performance.
- If a material defect leads to damage, we shall be liable in accordance with the statutory provisions insofar as this concerns personal injury or the damage falls under the product liability law or is based on intent or gross negligence.
- If the damage is based on a culpable breach of an essential contractual obligation or a "cardinal obligation", we shall only be liable for the foreseeable damage specific to the contract, with the exception of the cases cited in para. 3.
- Any further contractual and tortious claims of the customer are excluded. With the exception of the cases cited in para. 6, we shall not be liable in particular for damage that has not occurred to the delivery item itself or for the loss of profit or any other financial losses of the customer.

§ 10 Other liability for damages

- The provisions in § 9, para. 6 - 8 shall also apply to claims for damages due to other breaches of duty. In the event of a breach of a pre-contractual obligation or an impediment to performance already existing at the time of conclusion of the contract (§§ 311, para. 2, 311a of the BGB), our compensation obligation shall be limited to the negative interest.
- The provisions of § 9, para. 6-8 shall apply accordingly to our liability in tort.
- Insofar as our liability is excluded or limited, this shall also apply to the personal liability of our employees, workers, staff, representatives and vicarious agents.

§ 11 Retention of title

- Ownership of the delivered goods shall remain reserved until all our claims against the customer arising from the business relationship – including future claims arising from contracts concluded at the same time or later – have been settled. This also applies if claims are included in a current invoice and the balance has been struck and accepted. Ownership shall not be passed on to the customer until they have repaid all of their liabilities to us, irrespective of the legal basis of the liability. We are obligated to release our securities should their value exceed our claims by more than 10 percent.
- The purchaser is entitled to sell or process the goods in the orderly course of business. This right shall expire upon cessation of payments or the application for or opening of insolvency proceedings. Any processing shall be carried out by the customer on our behalf without any obligation on our part. In the event of processing, combining or mixing the reserved goods with other goods, a co-ownership share in the new item shall always arise for us, notably in relation of the value (= gross invoice value including ancillary costs and taxes) of the reserved goods to the value of the new item in the event of processing or in relation of the value of the reserved goods to the value of the other goods in the event of combining or mixing.
- The customer hereby assigns all claims to us accrued from the resale of the goods. The customer shall remain authorised to collect these claims even after the assignment. Our right to collect the claims ourselves shall remain unaffected; however, we shall not make use of this right as long as the customer duly fulfils their payments and other obligations. Upon request, the customer shall inform us of the assigned claims and their debtors, provide all information necessary for collection, hand over the relevant documents and inform the debtors of the assignment.
- In the event of conduct in breach of contract on the part of the customer – in particular in the event of default in payment – we shall be entitled to withdraw from the contract and to take back the goods. To this end, the customer hereby irrevocably permits us to enter its business and storage premises without hindrance and to take the goods with us.
- Insofar as and for as long as the reservation of title exists, the customer may neither assign by way of security nor pledge goods or items manufactured from them without our consent.
- The customer shall immediately inform us in writing of any seizures or other interventions by third parties. The customer is prohibited from entering into any agreements with their own customers which may affect our rights.
- We undertake to release the security to which we are entitled at the request of the customer and at our discretion to the extent that the realisable value of the security exceeds the claim to be secured by more than 10% or its nominal amount by more than 50%.

§ 12 Final provisions

- Any invalidity of individual provisions shall not affect the validity of the remaining provisions.
- If the customer is a merchant, the place of jurisdiction for all disputes with them shall be the registered office of elero GmbH in 73278 Schlierbach. The place of jurisdiction is not exclusive.
- German law shall apply exclusively to the exclusion of the UN Convention on Contracts for the International Sale of Goods (CISG).
- In accordance with the provisions of the Federal Data Protection Act, we would like to point out that we store personal data (name, address) of the customer by EDP technology for internal purposes only.

Excellent control in action.

elero is one of the world's largest manufacturers of electric drives and control systems for intelligent building automation.

As a wholly owned subsidiary of the Italian Nice Group, we specialize in roller shutters and sun protection. We are convinced that intelligent, comprehensive control of light and temperature significantly improves well-being and living comfort. That's why we are constantly developing new products to meet the demands of the market and offer innovative control systems and tried-and-tested drive technology for almost every requirement.

www.elero.com

elero GmbH
Maybachstr. 30
73278 Schlierbach
Germany

info.elero@niceforyou.com

Sun Shading Solutions Nice